

Parc Cybi, Holyhead

Final Report on Excavations

Volume 2: Figures

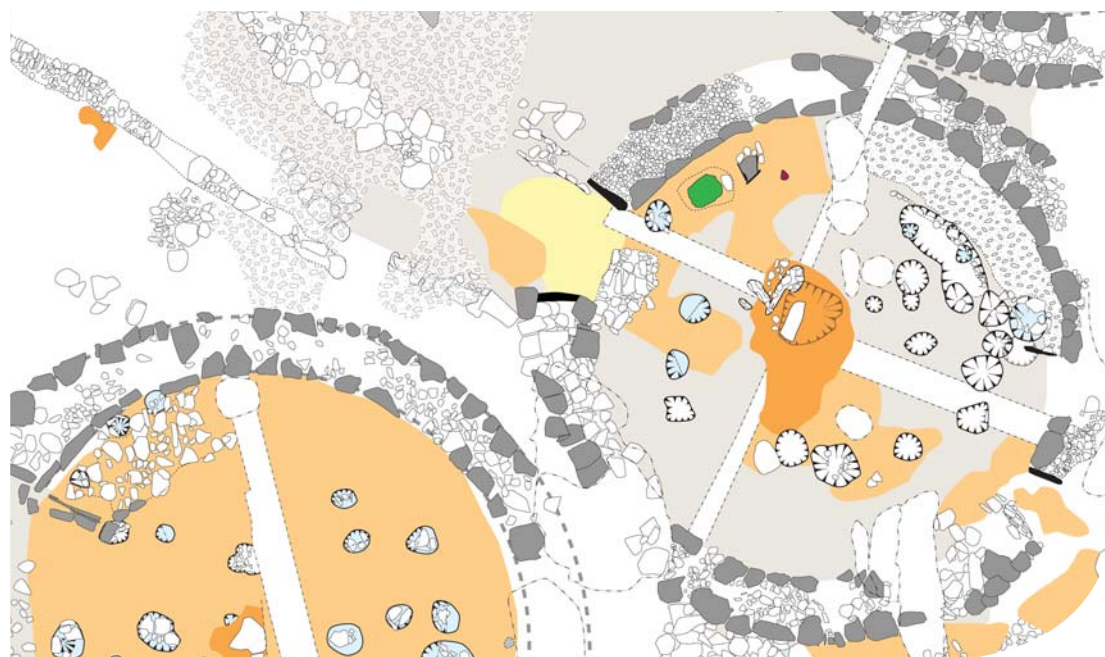

Parc Cybi, Holyhead

Final Report on Excavations

Volume 2: Figures

Project No. G1701

Report No. 1512

Event PRN 45467

Prepared for: Welsh Government

January 2020 (corrections December 2020)

Illustrations by: Jane Kenney, Neil McGuinness, Bethan Jones, Carol Ryan Young

Cover image: part of a plan of the Iron Age roundhouse settlement

Cyhoeddwyd gan Ymddiriedolaeth Achaolegol Gwynedd
Ymddiriedolaeth Archaeolegol Gwynedd
Craig Beuno, Ffordd y Garth,
Bangor, Gwynedd, LL57 2RT

Published by Gwynedd Archaeological Trust
Gwynedd Archaeological Trust
Craig Beuno, Garth Road,
Bangor, Gwynedd, LL57 2RT

Cadeiryddes/Chair - David Elis-Williams, MSc., CIPFA.
Prif Archaeolegydd/Chief Archaeologist - Andrew Davidson, B.A., M.I.F.A.

Mae Ymddiriedolaeth Archaeolegol Gwynedd yn Gwmni Cyfyngedig (Ref Cof. 1180515) ac yn Elusen (Rhif Cof. 508849)
Gwynedd Archaeological Trust is both a Limited Company (Reg No. 1180515) and a Charity (reg No. 508849)

**PARC CYBI, HOLYHEAD
(G1701)**

FINAL REPORT ON EXCAVATIONS

Event PRN 45467

List of Figures

- Figure 1. Topography and geology: location and relief of Holy Island with geological map of bedrock from Geology of Britain Viewer (British Geological Survey)
- Figure 2. Prehistoric sites on Holy Island with PRNs
- Figure 3. Iron Age and Roman sites on Holy Island with PRNs
- Figure 4. Medieval and selected later sites on Holy Island with PRNs
- Figure 5. Extracts of 16th, 17th and 18th century maps showing Holy Island and the crossings to it
- Figure 6. Areas and sub-areas of Parc Cybi and their status
- Figure 7. Location of prehistoric, Roman and medieval sites on Parc Cybi with PRNs (see appendix II for list of sites)
- Figure 8. Location of post-medieval sites and field systems on Parc Cybi with PRNs (see appendix II for list of sites)
- Figure 9. Plan of feature 50412 containing Mesolithic finds (PRN 31627) with inset showing location of Mesolithic finds across the site
- Figure 10. Detailed plan of the Early Neolithic building (PRN 31570), with an inset showing the stones in the fills of features 50092, 50120, 50167 and 50179
- Figure 11. Interpretive plan of the Early Neolithic building and associated features
- Figure 12. Sections of aisle postholes in the Neolithic building
- Figure 13. Sections of fire pits in the Neolithic building
- Figure 14. Sections of postholes in the Neolithic building
- Figure 15. Sections of pits and other features in the Neolithic building
- Figure 16. Pits and other features to the north of the Early Neolithic building including feature 50010 that contained a cannel-coal bead (sf1073), with inset section of posthole 50010
- Figure 17. Plan of Area H showing possibly prehistoric features (features mentioned in text labelled with context numbers)
- Figure 18. Distribution of finds in the Early Neolithic building
- Figure 19. Comparison of the Parc Cybi building with those from Llandygai near Bangor
- Figure 20. Natural hollow in Area E (PRN 18406) showing the location of features indicating temporary occupation
- Figure 21. Detailed plan of activity in the hollow in Area E (PRN 18406) with finds distribution
- Figure 22. Excavated features in Area M with inset of pottery from pit 40079
- Figure 23. Sections of selected pits and postholes in Area M
- Figure 24. Location plan of pits in Area I, with inset plans and sections of features 19075 and 21037
- Figure 25. Plan of pit group PRN 31572 with finds distribution
- Figure 26. Sections of pits in group PRN 31572
- Figure 27. Pit group in Area K9 (PRN 31573) with other nearby early features
- Figure 28. Selected sections of the pit group in Area K9 (PRN 31573) and nearby prehistoric features
- Figure 29. Pit group in Area D (PRN 31574), with selected sections inset
- Figure 30. General location of features in Area J
- Figure 31. Plan and sections of pits 70168, 70173 and 70181 (PRN 74831)
- Figure 32. Plan and sections of pits 70529 and 70503 (PRN 74832)
- Figure 33. Sections of burnt mound PRN 31582 with inset showing extent of mound and location of main sections
- Figure 34. Plan of features under the burnt mound PRN 31582 with sections of troughs
- Figure 35. Section through recut well (group 31303)
- Figure 36. Plan and sections of burnt mound PRN 31583 and nearby features
- Figure 37. Plans and sections of earth ovens PRN 31584, 31585 and 31586
- Figure 38. Plan and sections of possible burnt mound pits PRN 31587
- Figure 39. Cist cemetery/multiple cist barrow in Area M4 (PRN 31589)
- Figure 40. Selected sections and profiles through the cists
- Figure 41. Plan of D-shaped enclosure (PRN 31591), showing stone deposits in the fill

Figure 42. Plan of D-shaped enclosure fully excavated with inset showing the changing form of the monument

Figure 43. Sections through D-shaped enclosure and related features

Figure 44. Plan of ring ditch PRN 31590

Figure 45. Sections across ring ditch

Figure 46. Location of Tŷ Mawr standing stone (PRN 2501) and surrounding features

Figure 47. Resistance survey around the Tŷ Mawr Standing Stone by Geophysical Surveys of Bradford (from Ovenden 1990b)

Figure 48. Excavated features in Area K1

Figure 49. Detailed plan of timber roundhouse (PRN 31588) and nearby pits with selected sections

Figure 50. Bronze Age and other possibly prehistoric features in Area J

Figure 51. Plan of posthole group PRN 31576 with selected sections

Figure 52. Plan of posthole group PRN 31581 with selected sections

Figure 53. Plan of four-post structures and related features (PRN 31577) with selected sections

Figure 54. Plan of possible structures and related features (PRN 31578) with selected sections

Figure 55. Plan of four-post and 6-post structures and related features (PRN 31579) with selected sections

Figure 56. Plan of northern features in Area J (PRN 31580) with selected sections

Figure 57. Location of pits PRN 31575 and detailed excavation plan

Figure 58. Location and overall view of main roundhouse settlement (PRN 14599) in Areas B2 and F1

Figure 59. Investigation of the marsh edge deposits in Area F1

Figure 60. Sections of the deposits on the edge of the marsh

Figure 61. Pre-roundhouse settlement features in Areas B2 and F1, with inset showing details of Late Neolithic activity

Figure 62. Selected sections through pre-roundhouse settlement ditches and related deposits

Figure 63. Reinterpretation of west facing section through walls 90120 and 90464

Figure 64. Reinterpretation of north-west facing section through walls 90120 and 90464

Figure 65. Overview of centre of the roundhouse settlement (PRN 14599) showing structures of all phases

Figure 66. Phases of the roundhouse settlement

Figure 67. Summary matrix for the roundhouse settlement showing dated contexts

Figure 68. Roundhouse E and first phases of roundhouses A and B

Figure 69. Sections through roundhouse E

Figure 70. Sections through roundhouse A and between roundhouses A and E

Figure 71. Details of the two phases of the porch of roundhouse A

Figure 72. Sections through roundhouse B and stone deposits to SE of roundhouse

Figure 73. Roundhouse B, its pathway and structures 93004 and 94019

Figure 74. Earliest phase of roundhouse I

Figure 75. Later phase of roundhouse A and earlier phase of roundhouse C

Figure 76. Later phases of roundhouse B and roundhouse C

Figure 77. Sections across roundhouse C

Figure 78. The later phase of roundhouse I and structure H

Figure 79. Structure F and nearby features with selected sections

Figure 80. The western part of Area F1 with part of Area E (inset showing detail of group 93308)

Figure 81. Distribution of finds from the roundhouse settlement

Figure 82. Plan of relationship between structure 22171, gully 25047 and the roundhouse settlement

Figure 83. Pit group 25046 in Area B1 and structure 22171 in Area L3 (PRNs 31592 and PRN 31593)

Figure 84. Ditches within Area B3 (PRN 31594), with selected sections

Figure 85. Plans and sections of pit group 19073 and neighbouring features (PRN 31598)

Figure 86. Clay-walled roundhouses in Area K7 (PRN 31595)

Figure 87. Selected sections of features in the clay-walled roundhouses

Figure 88. Plan of the combined evidence, geophysical and evaluation trenches, for a roundhouse settlement in Area K5 (PRN 14602)

Figure 89. Plan of features in Areas K2 and K3 with section of culvert

Figure 90. Building complex in Area K9 (PRN 31596), with sections of some of the outlying features

Figure 91. Detail of building complex in Area K9, western part, with insets showing pit 80041 fully excavated and stone layers over structure 80527

Figure 92. Detail of building complex in Area K9, eastern part

Figure 93. Selected sections of the building complex in Area K9

Figure 94. Selected sections of the building complex in Area K9

Figure 95. Selected sections of the building complex in Area K9

Figure 96. Selected sections of the building complex in Area K9

Figure 97. Finds distribution in the building complex in Area K9

Figure 98. Roman period trackway and field boundaries across Area J (PRN 31597), with Cae Glas evaluation trenches marked

Figure 99. Western end of trackway in Area J

Figure 100. Sections of western end of trackway in Area J

Figure 101. Eastern end of trackway in Area J, with selected sections

Figure 102. Part of cover sheet for book of Penrhos Estate maps showing route of 18th century tracks and roads (Image courtesy of Archives and Special Collections, Bangor University (Penrhos II, 772, date 1769))

Figure 103. Plan of long cist cemetery (PRN 31600), with inset showing its location on top of the hill

Figure 104. Selected sections from the long cist cemetery

Figure 105. Sections of corn dryers

Figure 106. Plans and sections of corn dryers 80137, 21051, 21229 and 22158

Figure 107. Part of a page from Penrhos II 772 showing the farms of Tyddyn Pioden (F) and Merddyn Poeth (E) (1769) (Image courtesy of Archives and Special Collections, Bangor University (Penrhos II, 772))

Figure 108. Page from Penrhos II 772 showing the farm of Pen y Lone (1769) (Image courtesy of Archives and Special Collections, Bangor University (Penrhos II, 772))

Figure 109. Page from Penrhos II 804 showing the area of Parc Cybi in 1817 (Image courtesy of Archives and Special Collections, Bangor University (Penrhos II, 804))

Figure 110. Part of the tithe map for the Parish of Holyhead in the County of Anglesey (1841)

Figure 111. Parts of 25" County Series Anglesey sheets XI.6 and XI.7 (first edition 1889)

Figure 112. Parts of 25" County Series Anglesey sheets XI.6 and XI.7 (second edition 1900)

Figure 113. Parts of 25" County Series Anglesey sheets XI.6 and XI.7 (third edition 1924)

Figure 114. Tyddyn Pioden farm on maps of various dates (PRN 18403)

Figure 115. Tyddyn Pioden farmyard and boundaries overlaid on part of the 1769 estate map (Image courtesy of Archives and Special Collections, Bangor University (Penrhos II, 772))

Figure 116. Excavated remains of the Tyddyn Pioden farmhouse and earlier features

Figure 117. Details of maps showing Pen y Lôn and Bonc Dêg (Penrhos II Estate Maps, images courtesy of Archives and Special Collections, Bangor University)

Figure 118. Excavated remains of Pen y Lôn farmstead (PRN 14588) and Bonc Dêg (PRN 13928)

Figure 119. Sections through possible pony gin and related features next to the Pen y Lôn farmstead (PRN 14588)

Figure 120. Excavated remains relating to the earliest Trefignath farmstead (PRN 13929)

Figure 121. Details of estate maps showing Trefignath Farm (Penrhos II Estate Maps, images courtesy of Archives and Special Collections, Bangor University)

Figure 122. Trefignath Farm on the County Series 25 inch map (Anglesey sheet XI.07 first, second and third editions)

Figure 123. The rocky knoll at Trefignath Farm and features on and around it

Figure 124. Details of maps showing Merddyn Poeth (PRN 36509) (Penrhos II Estate Maps, images courtesy of Archives and Special Collections, Bangor University)

Figure 125. Plan of excavated features at Merddyn Poeth overlaid on second edition County Series map (1900)

Figure 126. Field boundaries in Area K7 (PRN 31608), with inset showing gully PRN 31619

Figure 127. Field boundaries in Area F2 and F3 (PRN 31609)

Figure 128. Plan and elevation of well PRN 31614

Figure 129. Plan of small enclosures in Area E (PRN 31618)

Figure 130. Small enclosures in Area D3

Figure 131. General plan showing the distribution of prehistoric pottery at Parc Cybi

Figure 132. Distribution of Cheshire Salt Containers (map by Dr Rob Philpott, up-dated version of Philpott 2010, fig 5.5, reproduced with kind permission)

Figure 133. Distribution of knapped stone within the roundhouse settlement in Areas B2 and F1

Figure 134. Distribution of worked stone objects within the roundhouse settlement in Areas B2 and F1

Figure 135. Location of Neolithic stone axes within and near the roundhouse settlement in Area B2

Figure 136. Distribution of spindle whorls and perforated stones in the core of the roundhouse settlement (both early and late phases shown)

Figure 137. Distribution of spindle whorls, perforated stones and shale objects in roundhouse E and structure F

Figure 138. Distribution of shale objects in the roundhouse settlement in Area B2

Figure 139. Location of smithing sites and other features discussed in the archaeometalurgical report

Figure 140. Plan of test pits and evaluation trenches showing depth of peat in Area G

Figure 141. Plan of bore holes and other investigation of the peat in Area K

Figure 142. Distribution of animal remains identifiable to species in the three phases of the roundhouse settlement in Areas B2/F1

Figure 143. Location of sites in Wales with dated Middle and Late Neolithic pottery

- Figure 144. Part of First Edition County Series map (1889) showing marshy area running inland from Penrhos Beach
- Figure 145. Extract from Stanley's map "Group of Ancient Habitations called Cytiau'r Gwyddelod, SE Flank of Holyhead Mountain" showing the "Danish fort" at Borth Wen (Stanley 1868, map opposite p385)
- Figure 146. Map showing relationship of Bronze Age monuments at Parc Cybi to Holyhead Mountain
- Figure 147. Location of Neolithic building in relation to Trefignath tomb with inset profiles across the site (NB horizontal and vertical scales on the profiles are different)
- Figure 148. Proposed relationship of the Early Neolithic building and the tomb at the three stages of the tomb's development
- Figure 149. Plan of location of burnt mounds and temporary occupation area showing topography
- Figure 150. Bronze Age features on Parc Cybi in relation to the topography and chambered tomb with a proposed routeway
- Figure 151. Distribution of Iron Age and Roman period settlements on Anglesey
- Figure 152. Plan of House 1, Trevelgue Head compared to Roundhouse I, Parc Cybi
- Figure 153. Distribution of long cists and other Early Medieval graves across Anglesey
- Figure 154. Location of Roman period sites on Holy Island with inset of Roman votive statuette from Rhoscolyn (drawn by Frances Lynch)
- Figure 155. Distribution of corn dryers on Parc Cybi
- Figure 156. Excavated ring gullies from England (part of figure 2.2 in Gardiner 2013, produced with the author's kind permission and assistance)

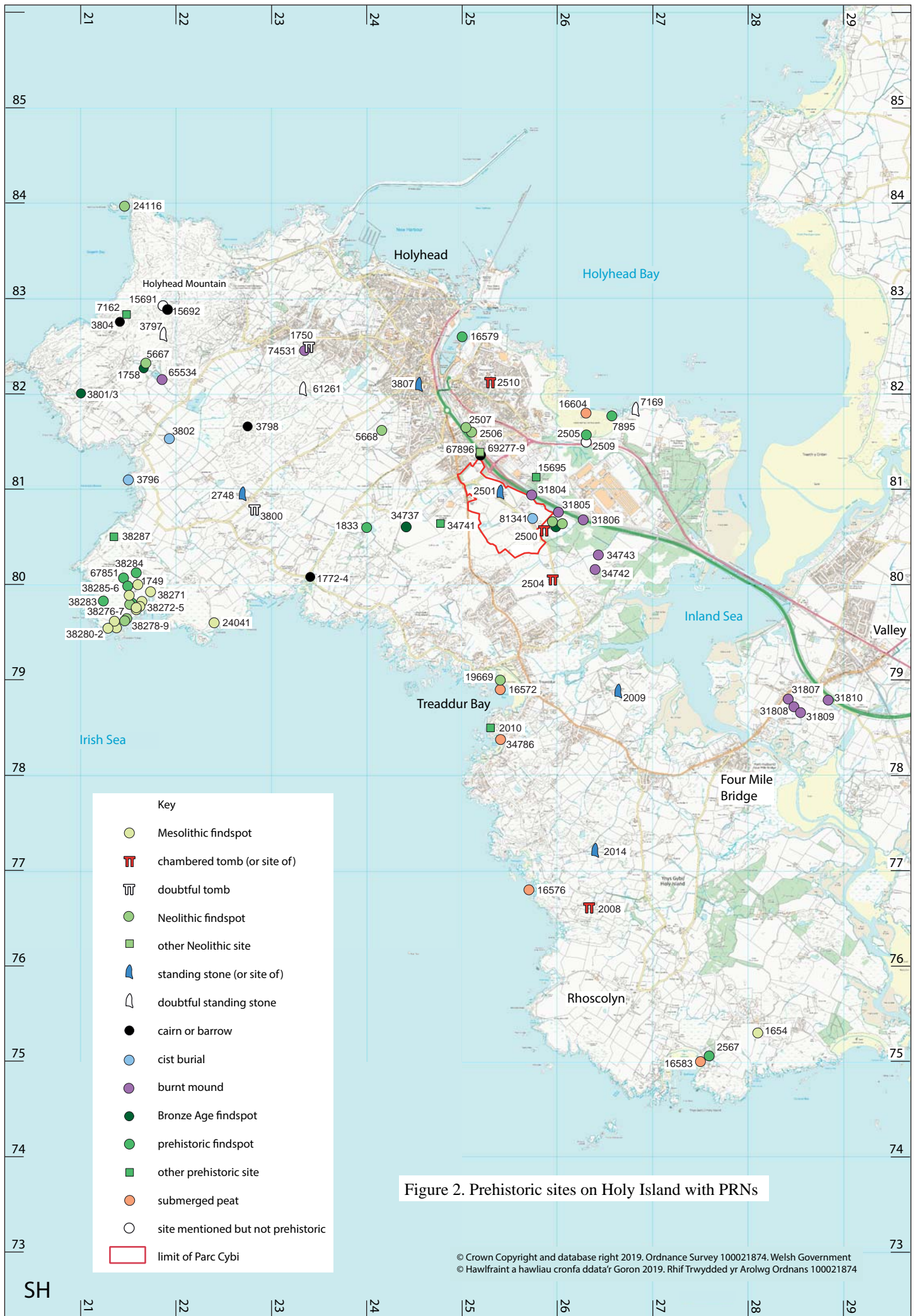
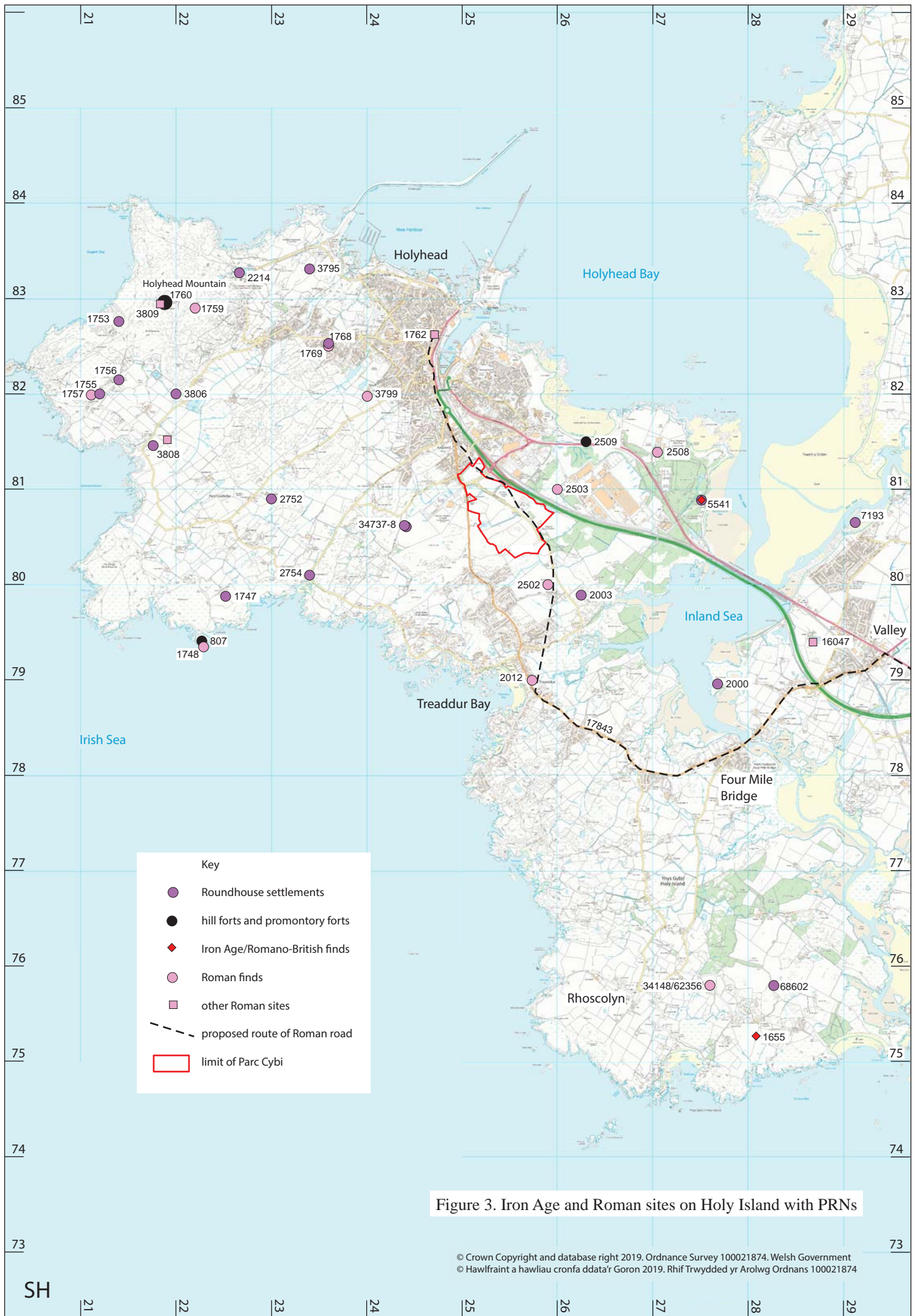

Figure 2. Prehistoric sites on Holy Island with PRNs



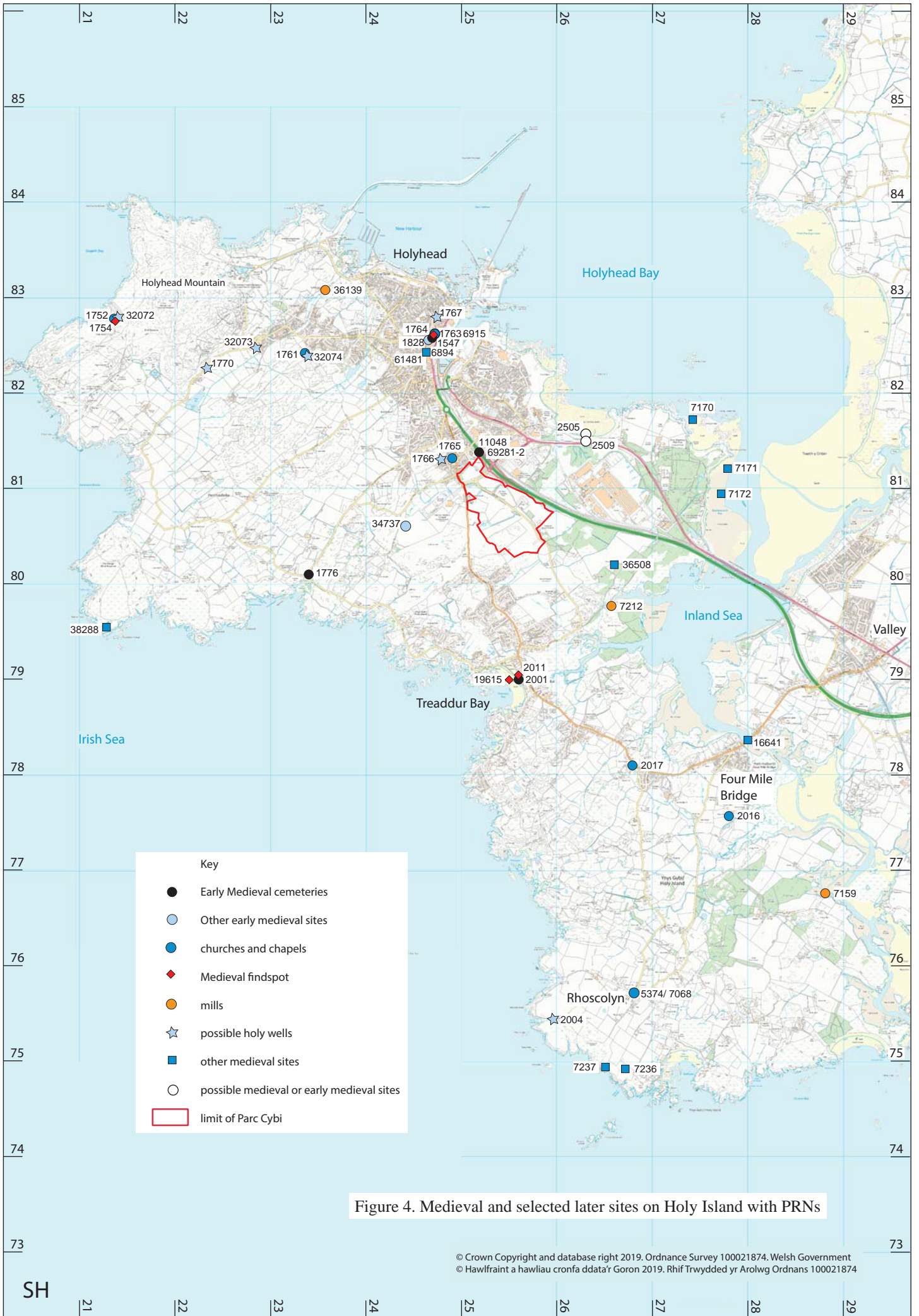
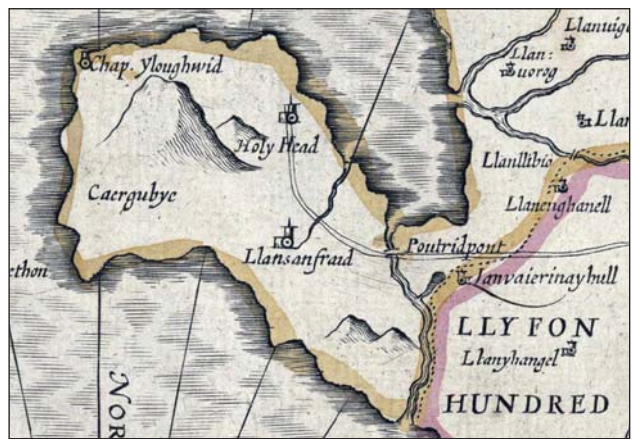

Figure 4. Medieval and selected later sites on Holy Island with PRNs



Saxton's map of Anglesey and Caernarvonshire (1578)



Speed's map of Anglesey (1611)



Penrhos Estate map, late 18th century (Bangor University Archives, Penrhos II 806)



John Ogilby's map of the London to Holyhead Road (1675)

Figure 5. Extracts of 16th, 17th and 18th century maps showing Holy Island and the crossings to it

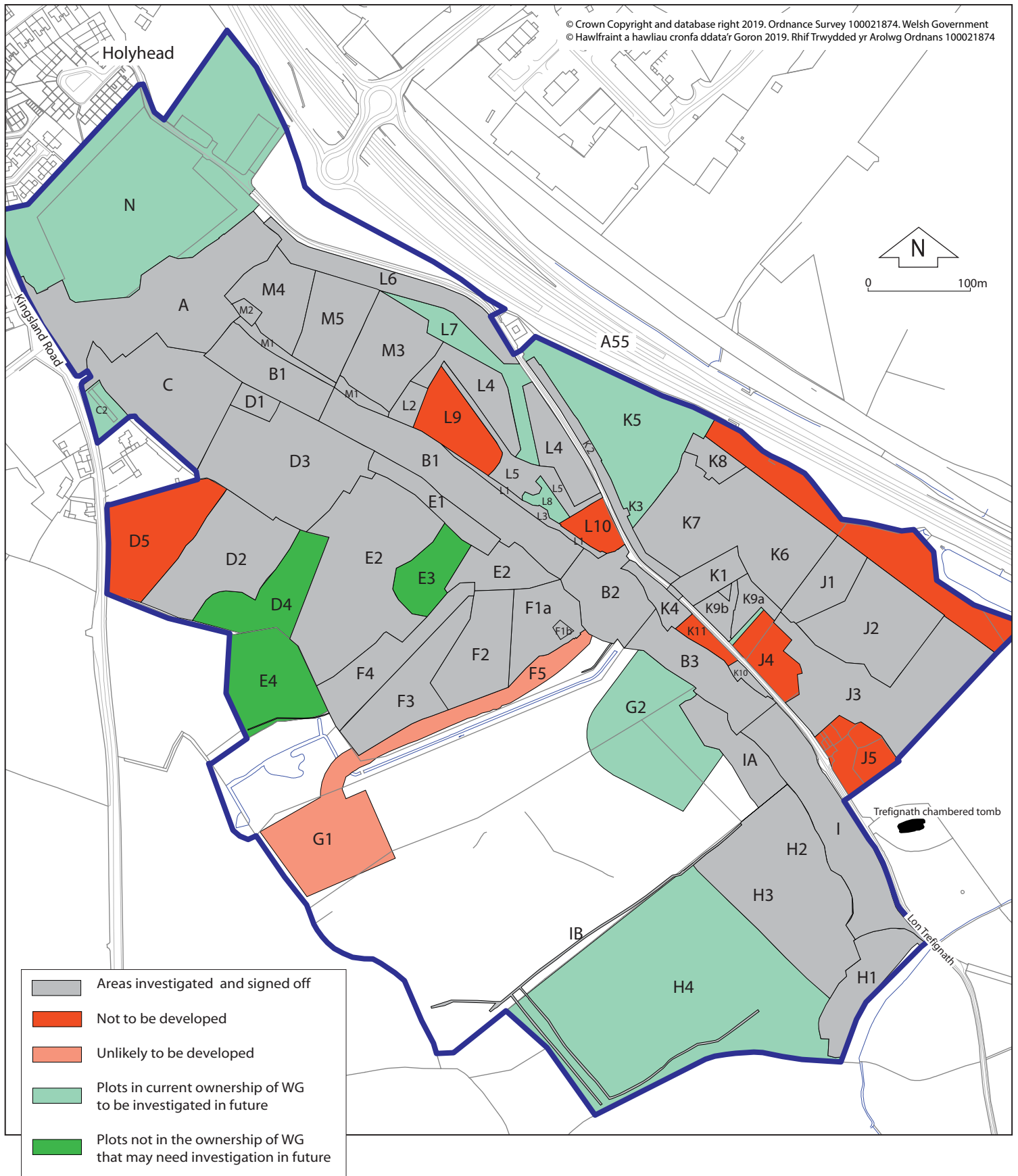

Figure 6. Areas and sub-areas of Parc Cybi and their status

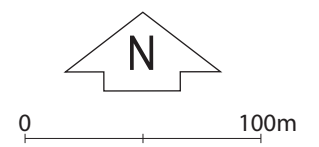
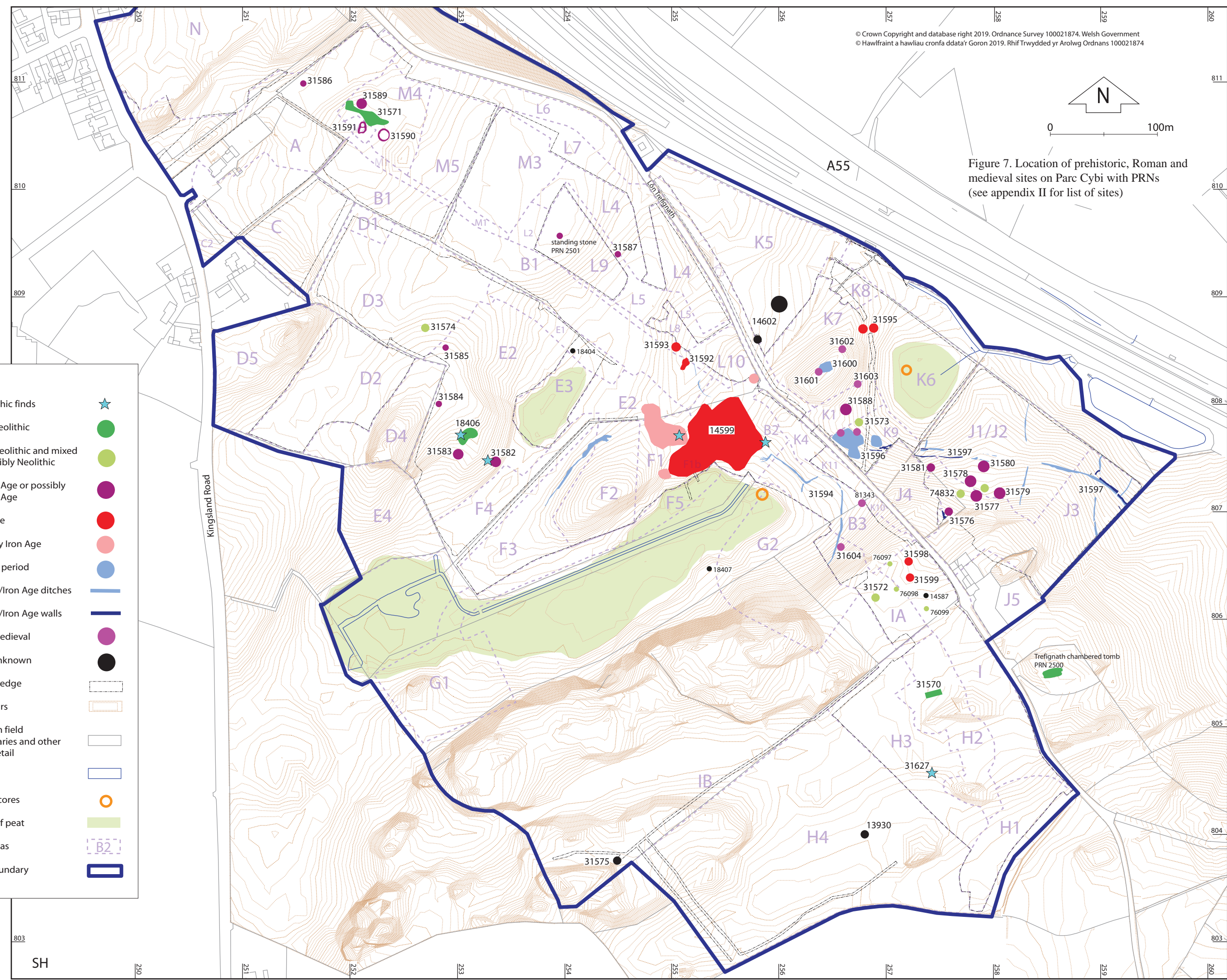

Figure 7. Location of prehistoric, Roman and medieval sites on Parc Cybi with PRNs (see appendix II for list of sites)

KEY

- Mesolithic finds ★
- Early Neolithic ●
- Later Neolithic and mixed or possibly Neolithic ●
- Bronze Age or possibly Bronze Age ●
- Iron Age ●
- Possibly Iron Age ●
- Roman period ●
- Roman/Iron Age ditches —
- Roman/Iron Age walls —
- Early medieval ●
- Date unknown ●
- Trench edge
- Contours
- Modern field boundaries and other map detail
- Water
- Pollen cores ○
- Areas of peat
- Site areas
- Site boundary



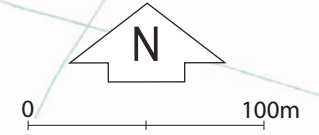
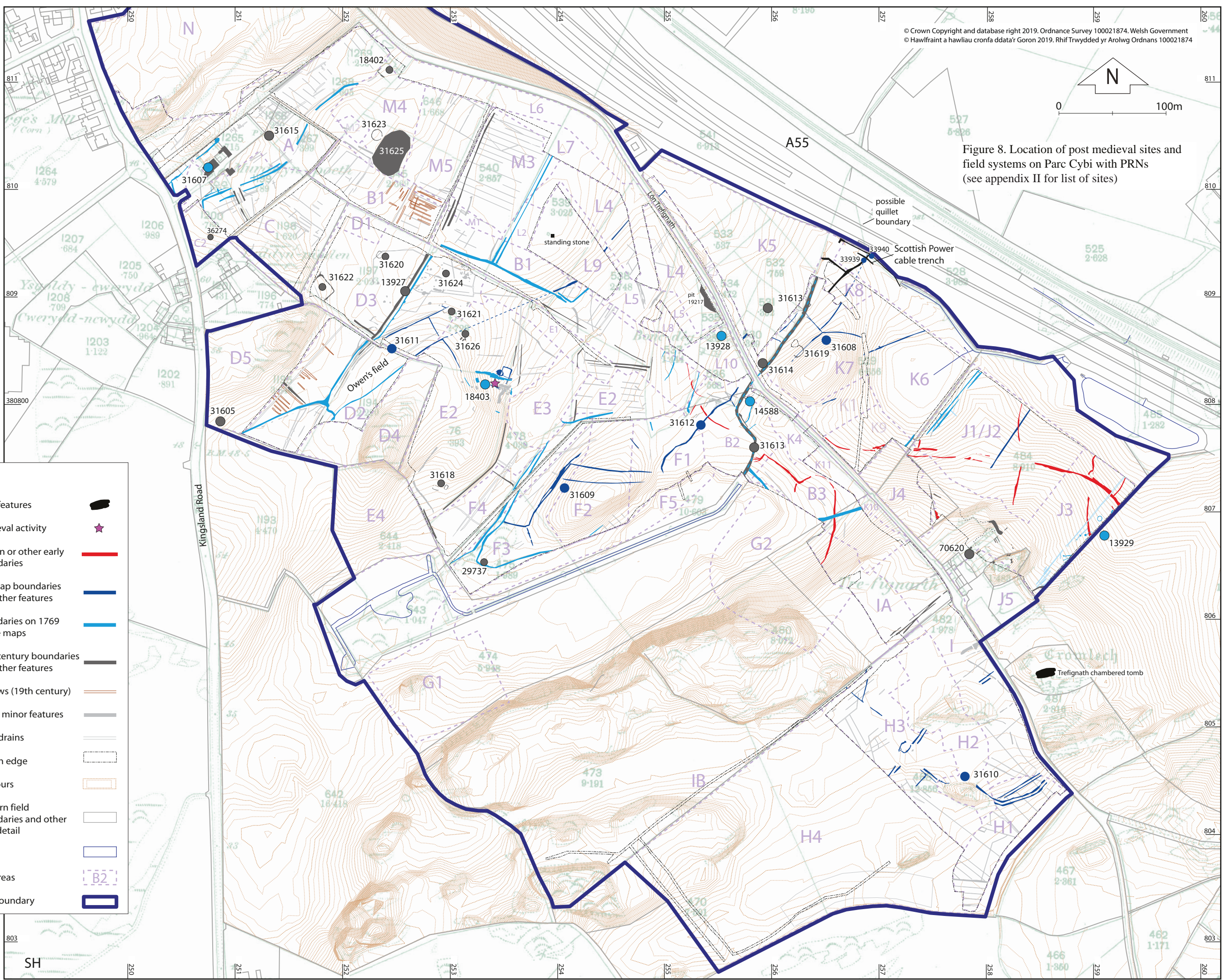

Figure 8. Location of post medieval sites and field systems on Parc Cybi with PRNs (see appendix II for list of sites)

KEY

- Early features
- Medieval activity
- Roman or other early boundaries
- Pre-map boundaries and other features
- Boundaries on 1769 estate maps
- 19th century boundaries and other features
- Furrows (19th century)
- Other minor features
- Land drains
- Trench edge
- Contours
- Modern field boundaries and other map detail
- Water
- Site areas
- Site boundary



SH

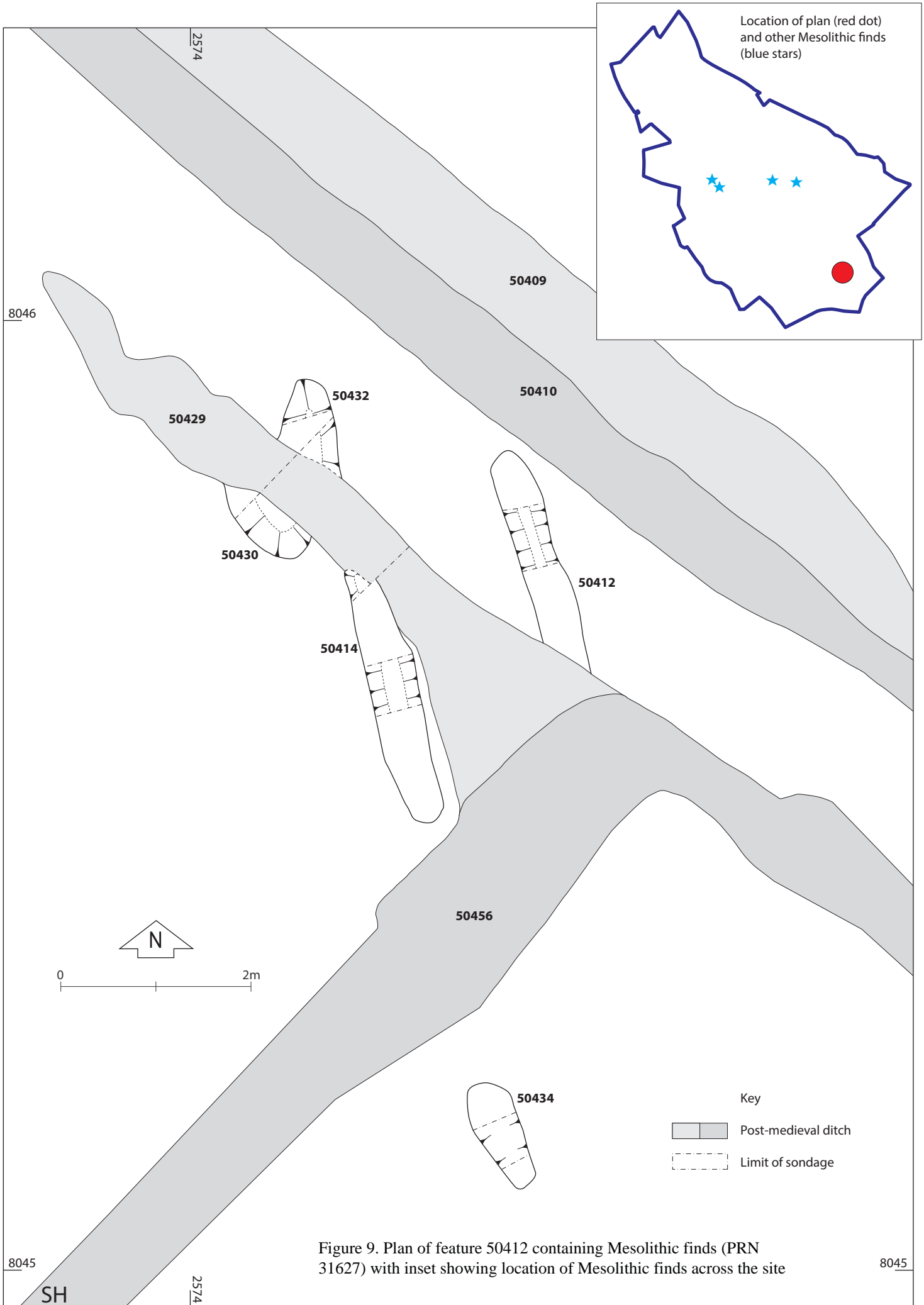

Figure 9. Plan of feature 50412 containing Mesolithic finds (PRN 31627) with inset showing location of Mesolithic finds across the site

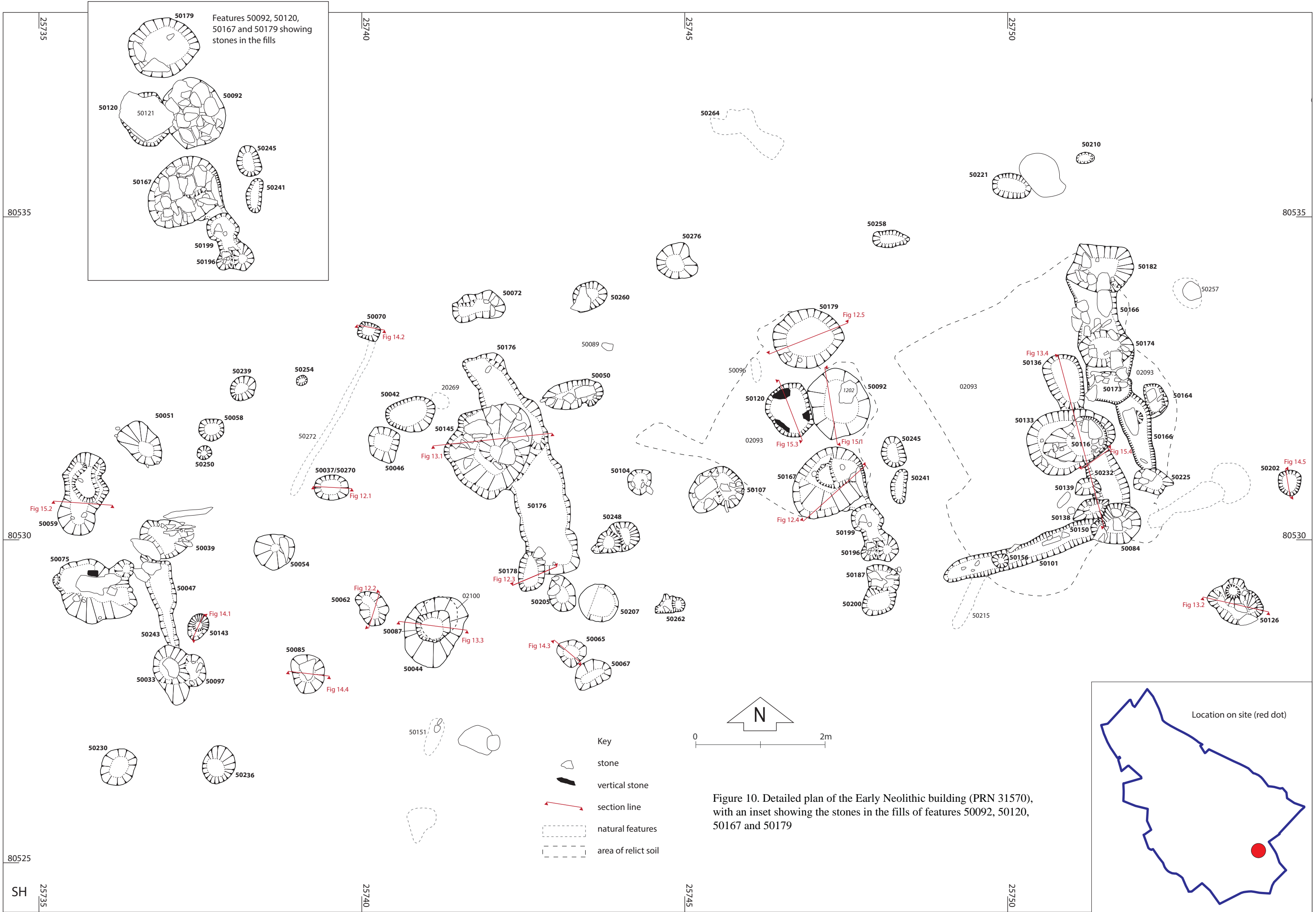
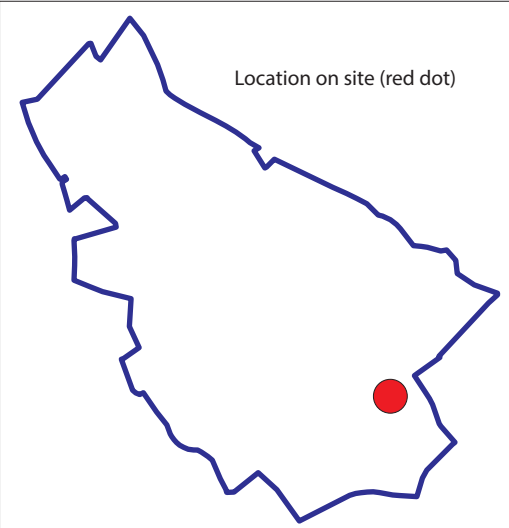

Figure 10. Detailed plan of the Early Neolithic building (PRN 31570), with an inset showing the stones in the fills of features 50092, 50120, 50167 and 50179



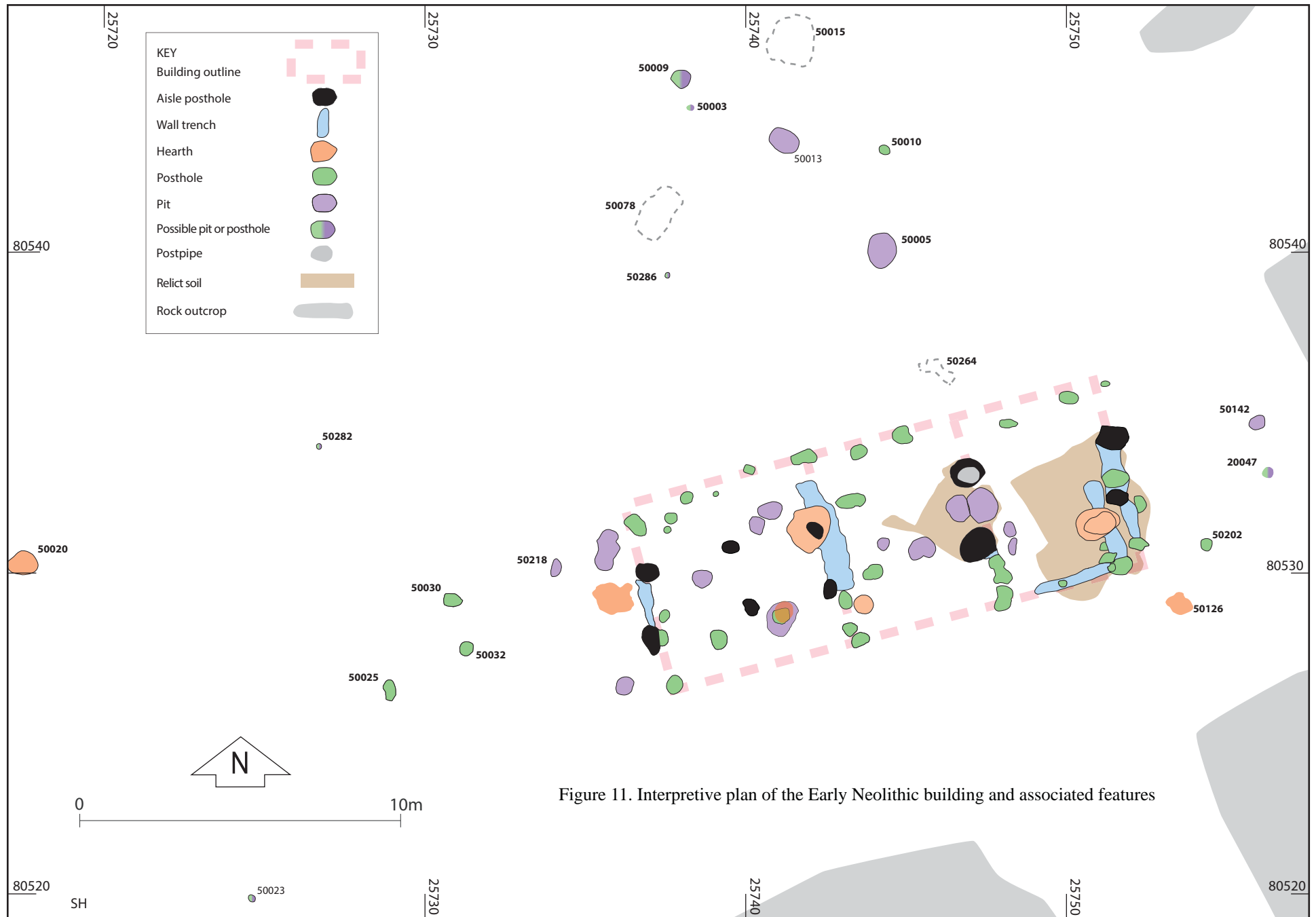

Figure 12. Sections of aisle postholes in the Neolithic building

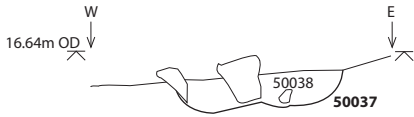

Fig. 12.1

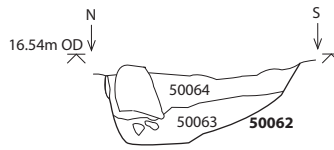

Fig. 12.2

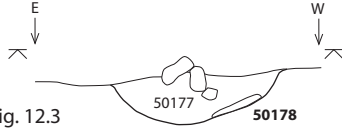

Fig. 12.3

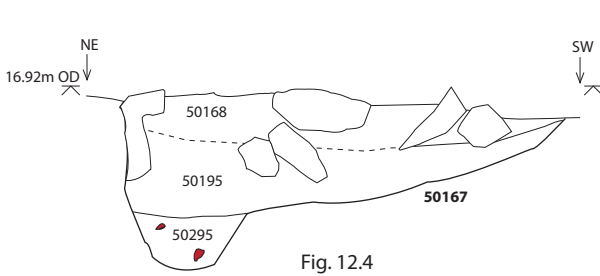

Fig. 12.4

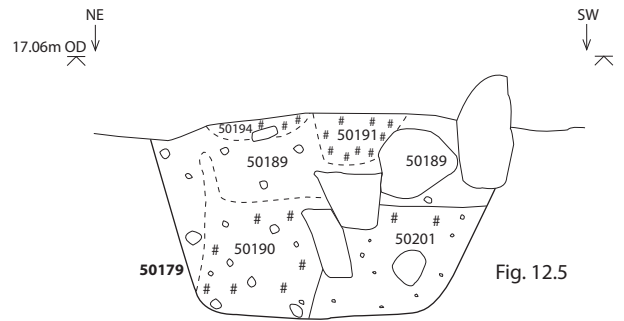

Fig. 12.5

Key

Charcoal

■ ■ Burnt clay

■ Heat altered hearth lining

○ Stone

■ Prehistoric pottery

See figure 10 for location of sections

Figure 13. Sections of fire pits in the Neolithic building

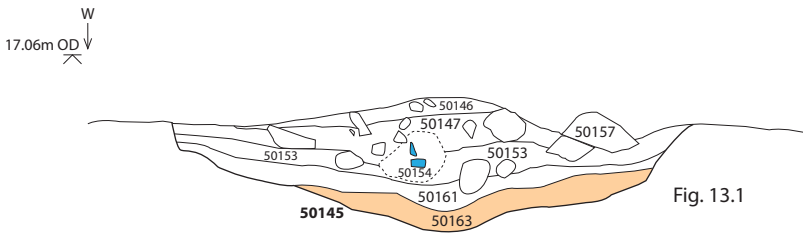

Fig. 13.1

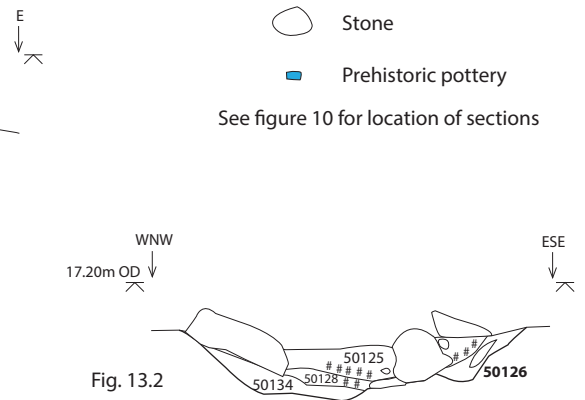

Fig. 13.2

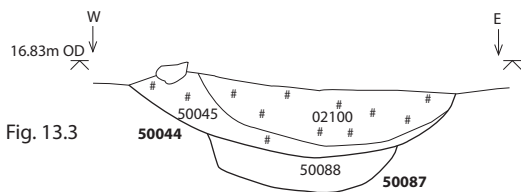

Fig. 13.3

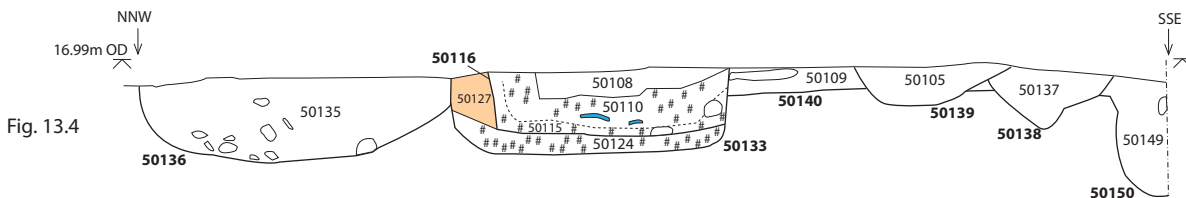
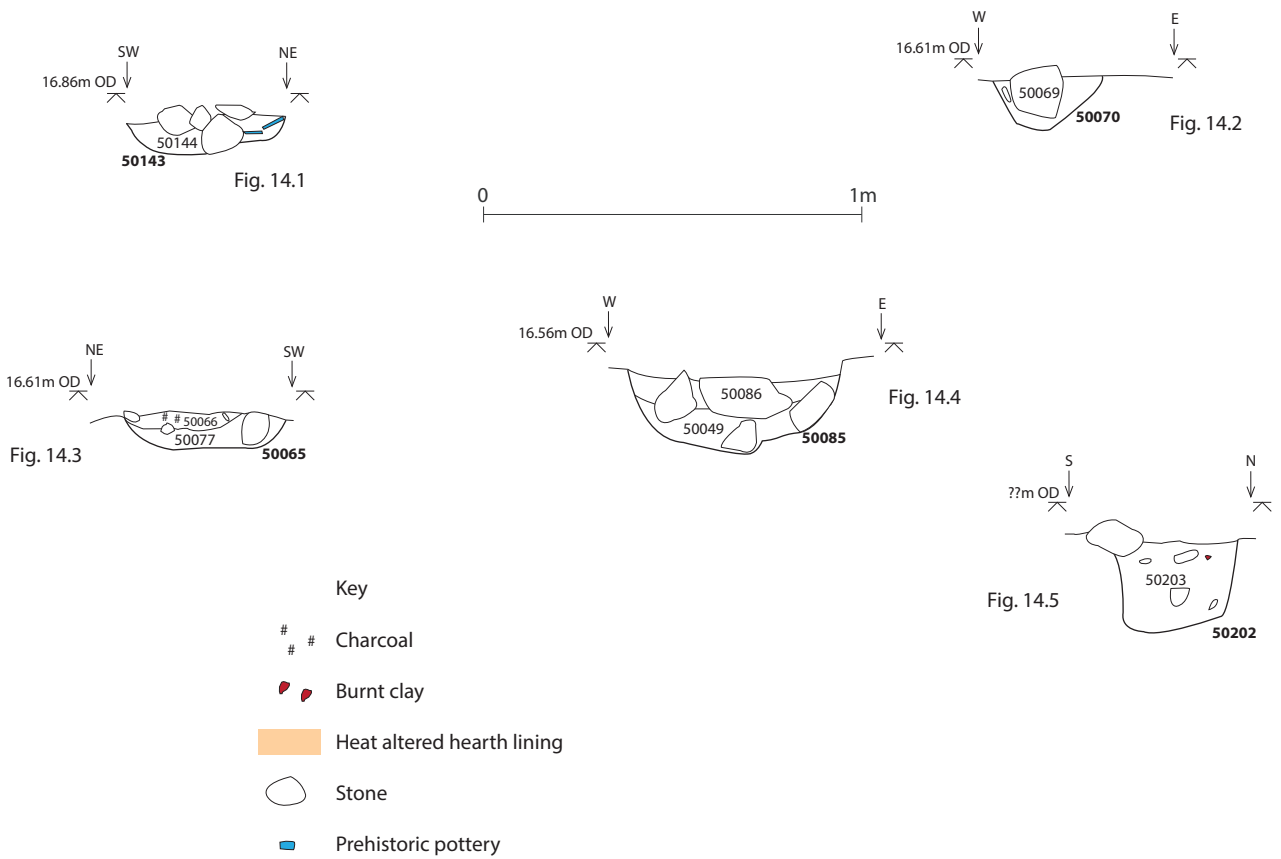

Fig. 13.4

Figure 14. Sections of postholes in and around the Neolithic building



See figure 10 for location of sections

Figure 15. Sections of pits and other features in and around the Neolithic building

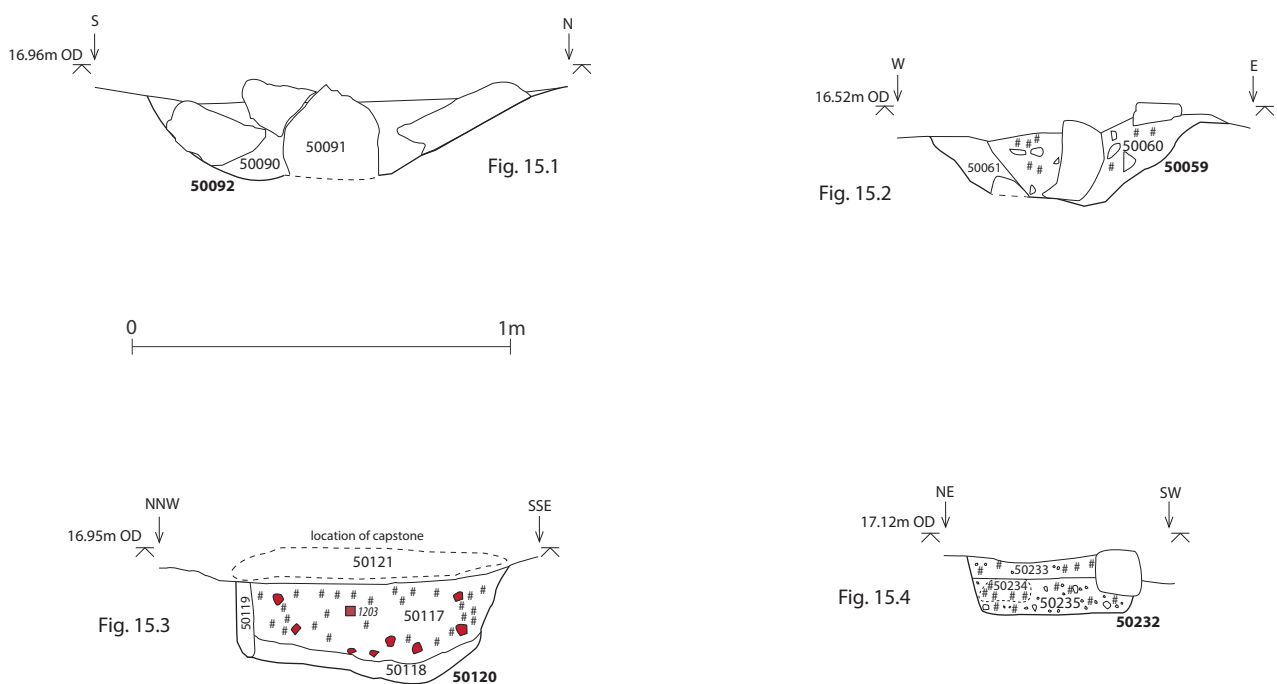

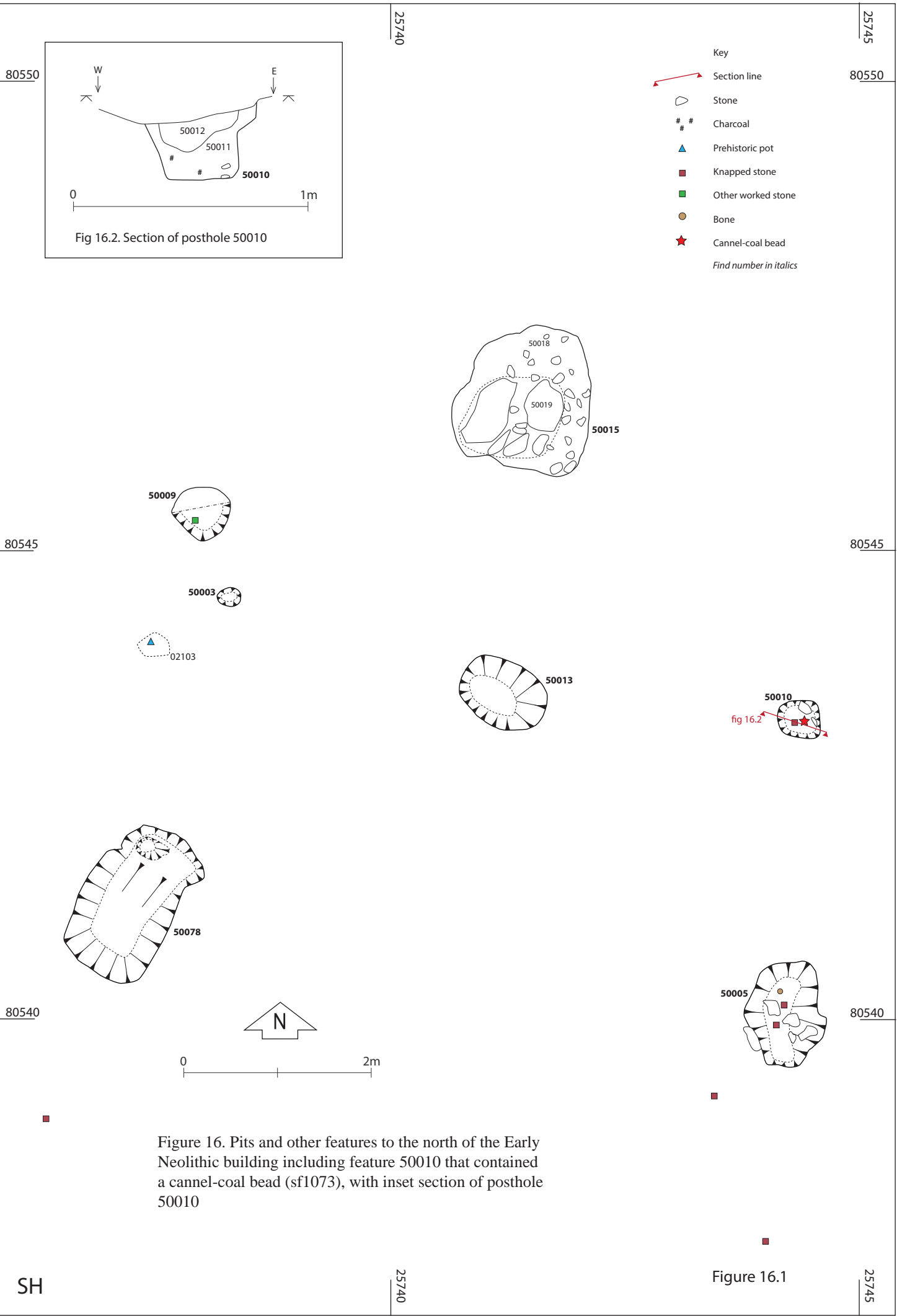

80550

25740

25745

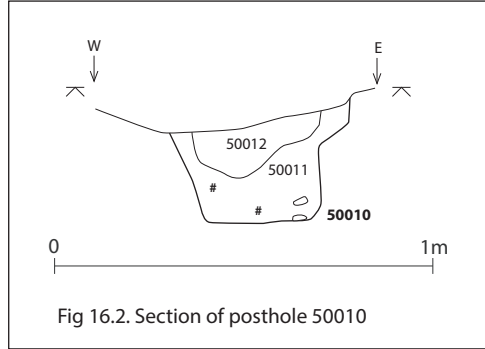

Fig 16.2. Section of posthole 50010

- Key
- Section line
 - Stone
 - Charcoal
 - Prehistoric pot
 - Knapped stone
 - Other worked stone
 - Bone
 - Cannel-coal bead
- Find number in italics*

80550

80545

80545

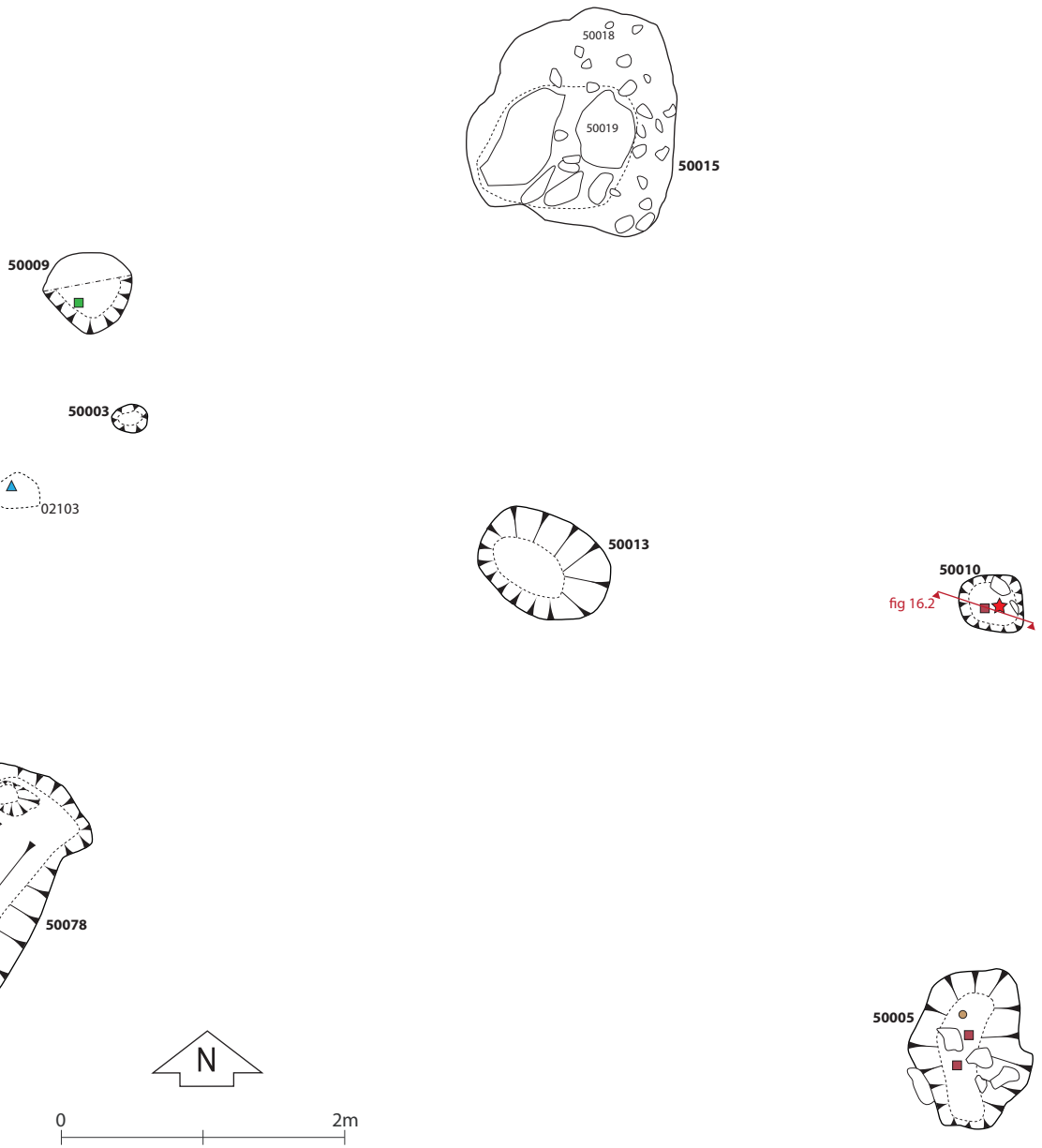

Figure 16. Pits and other features to the north of the Early Neolithic building including feature 50010 that contained a cannel-coal bead (sf1073), with inset section of posthole 50010

80540

80540

25740

25745

SH

Figure 16.1

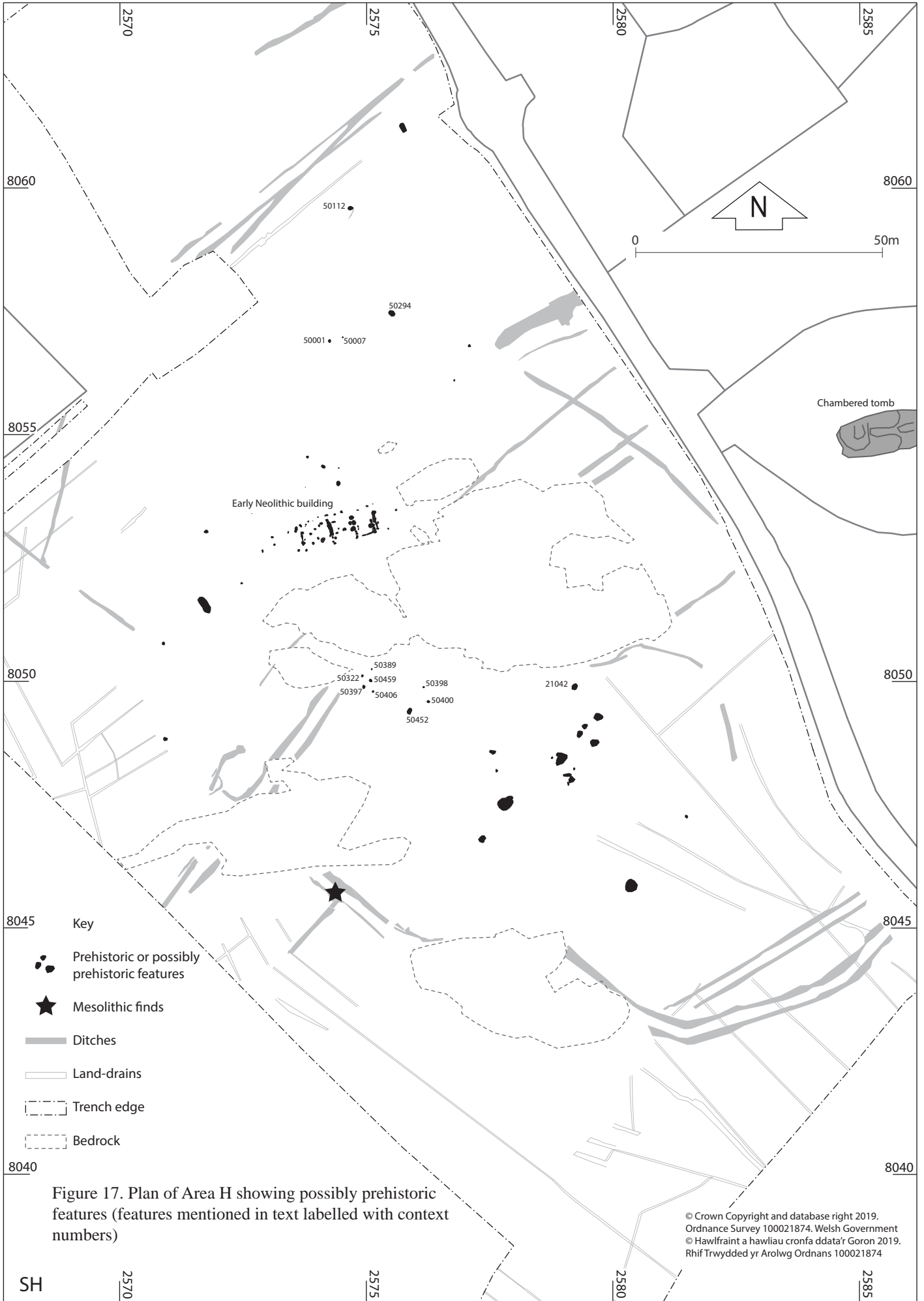

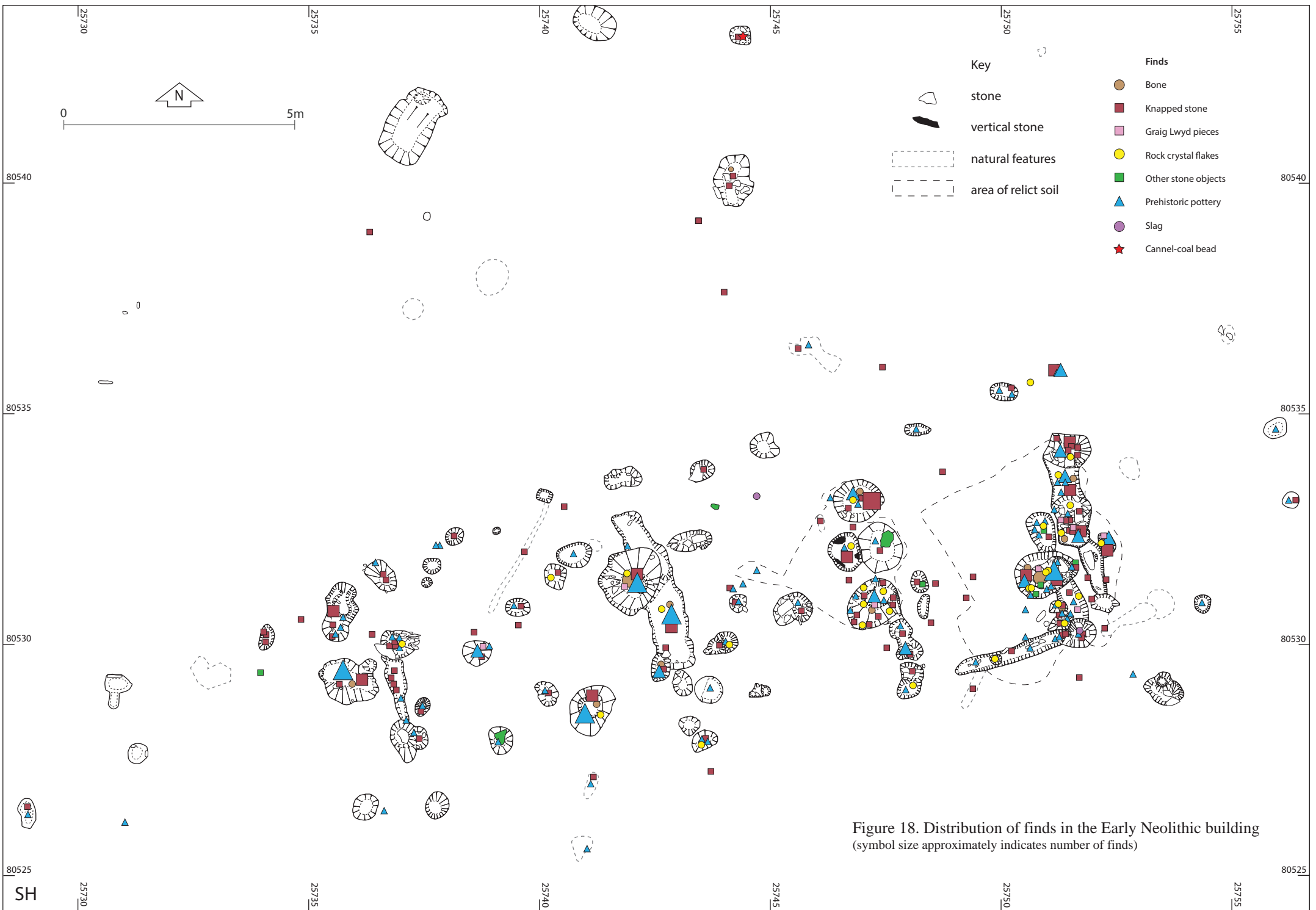
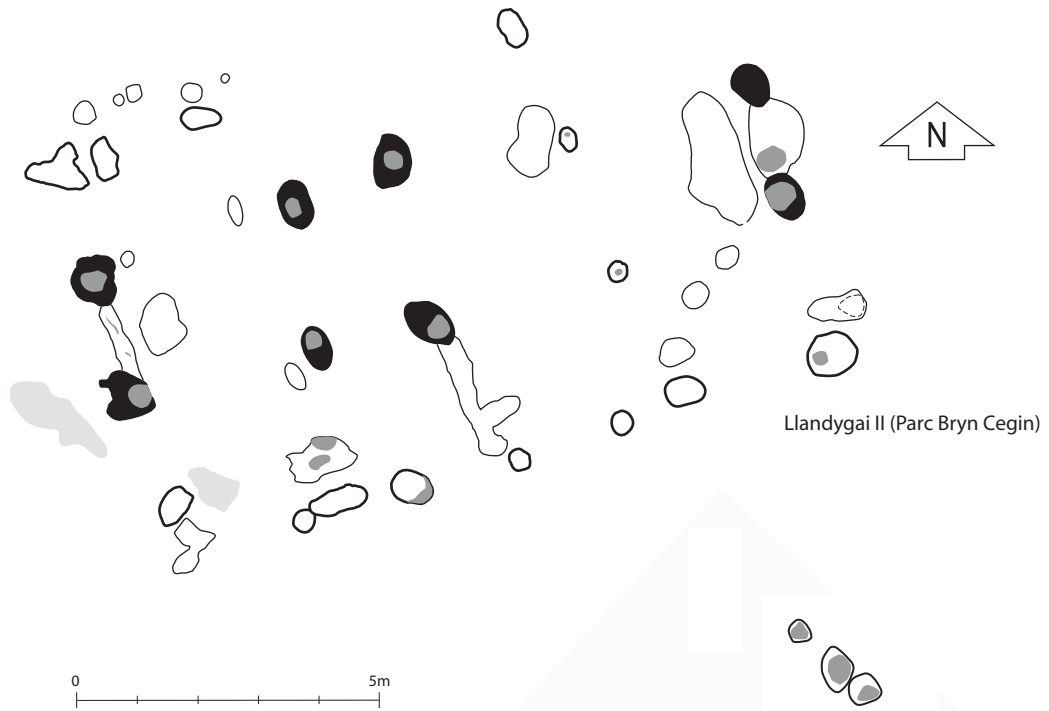
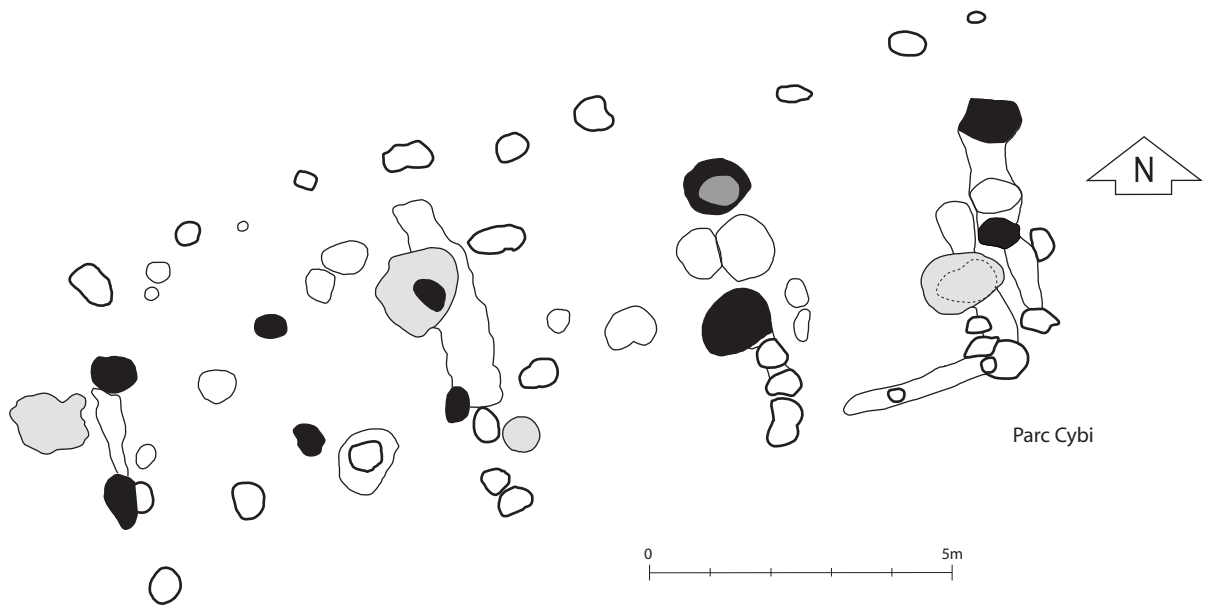

Figure 18. Distribution of finds in the Early Neolithic building (symbol size approximately indicates number of finds)



- Key
- Aisle postholes
 - Structural postholes
 - Postpipes
 - Hearths and burnt patches

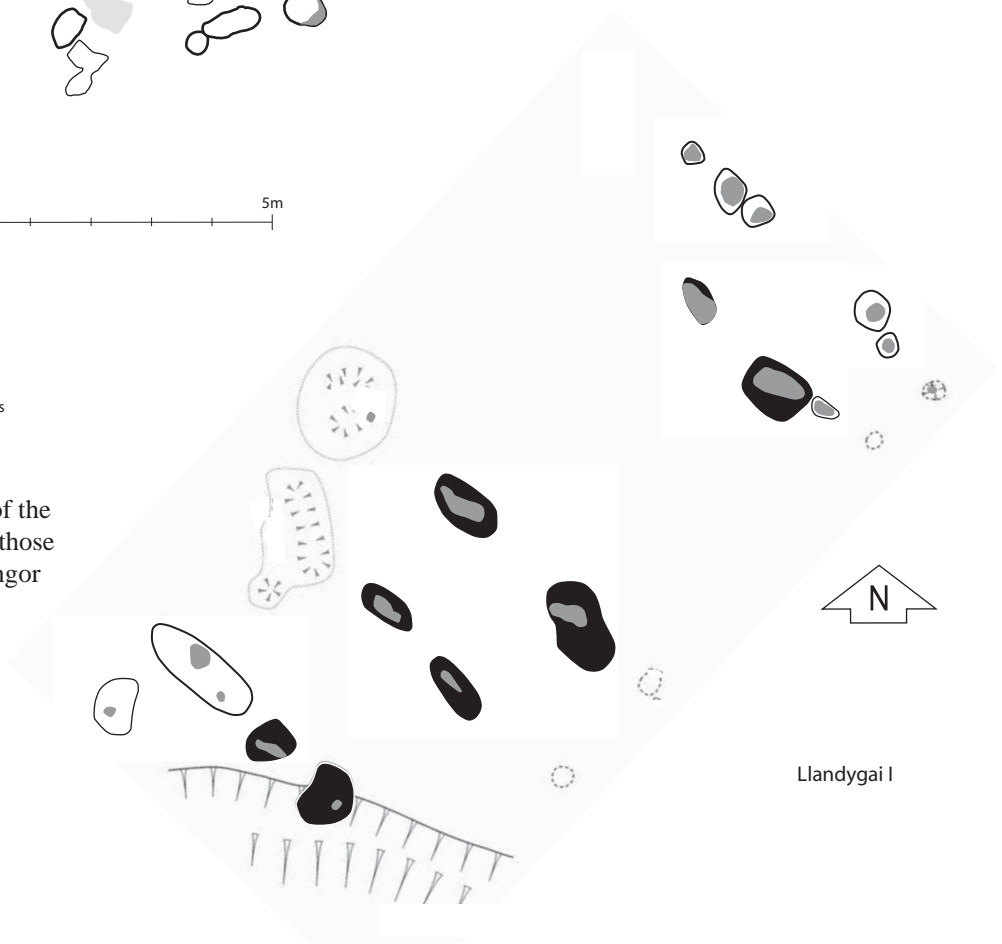

Figure 19. Comparison of the Parc Cybi building with those from Llandygai near Bangor

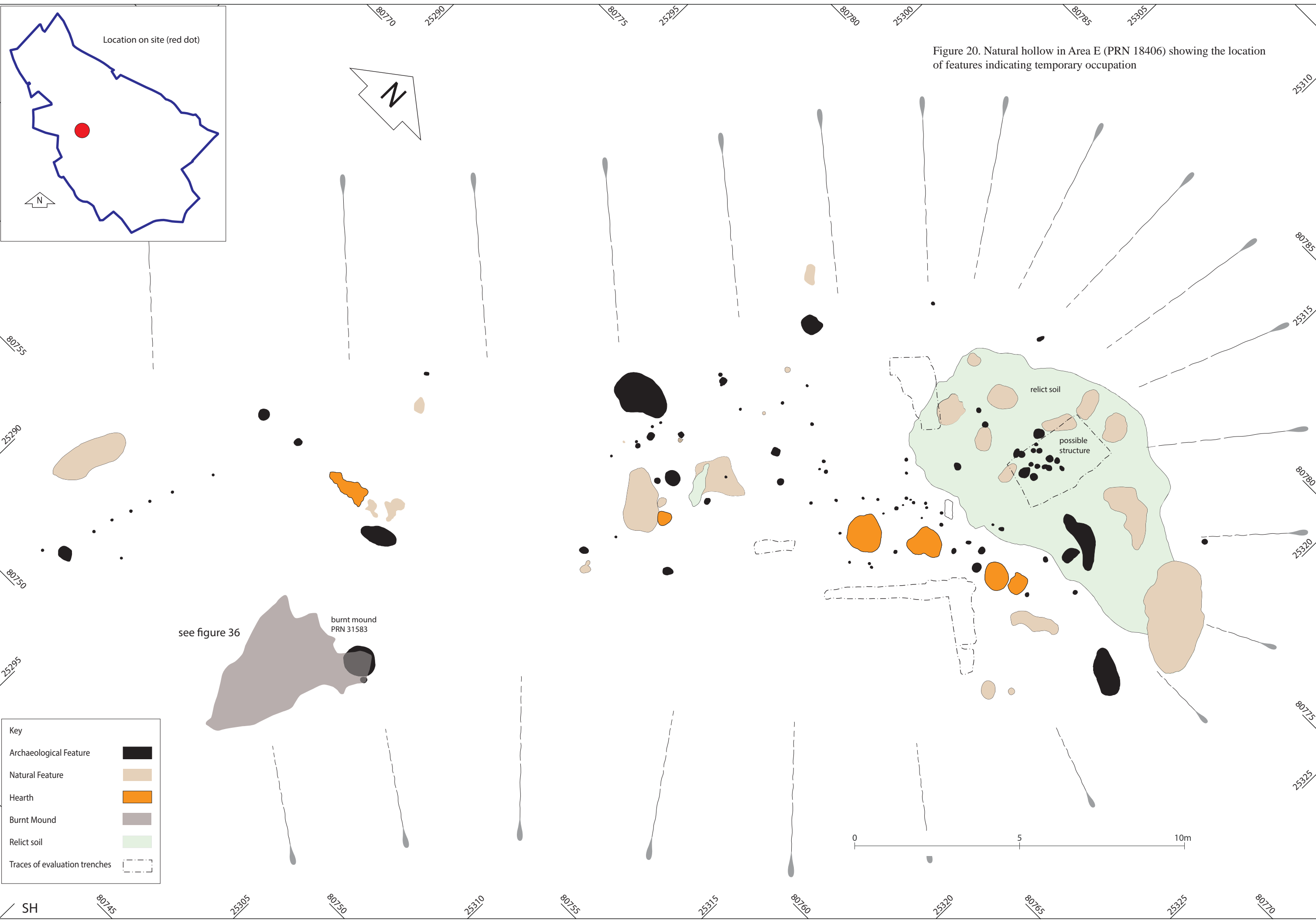

Figure 20. Natural hollow in Area E (PRN 18406) showing the location of features indicating temporary occupation

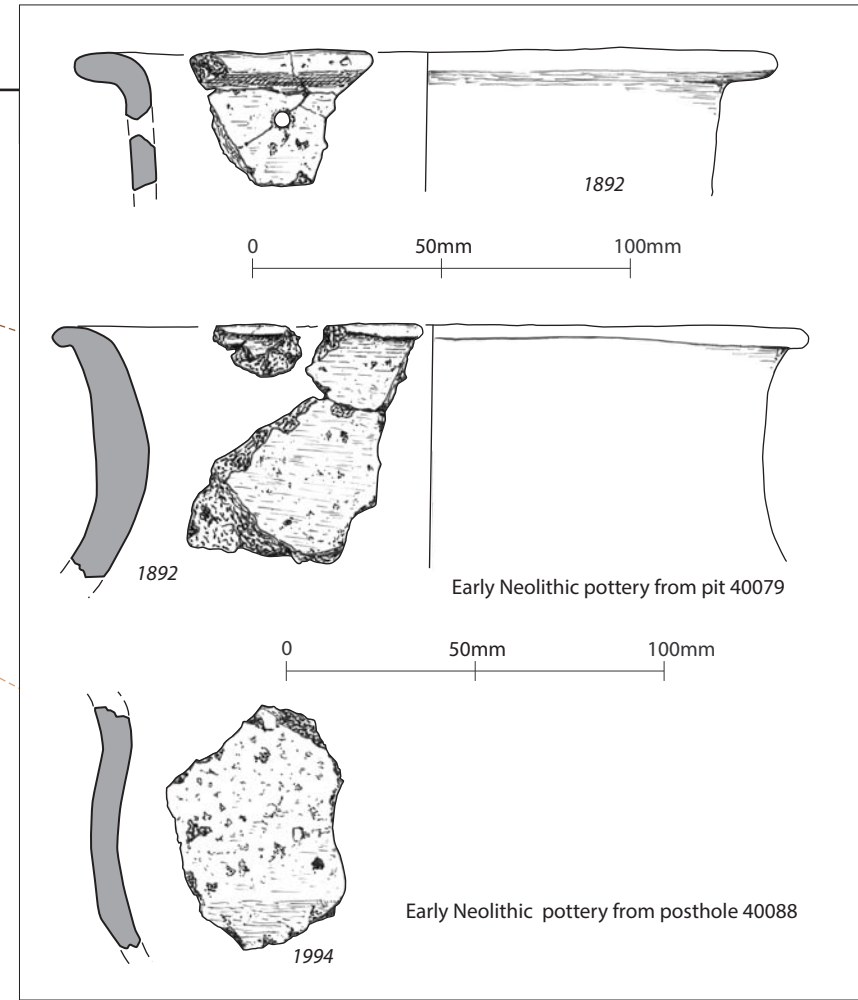
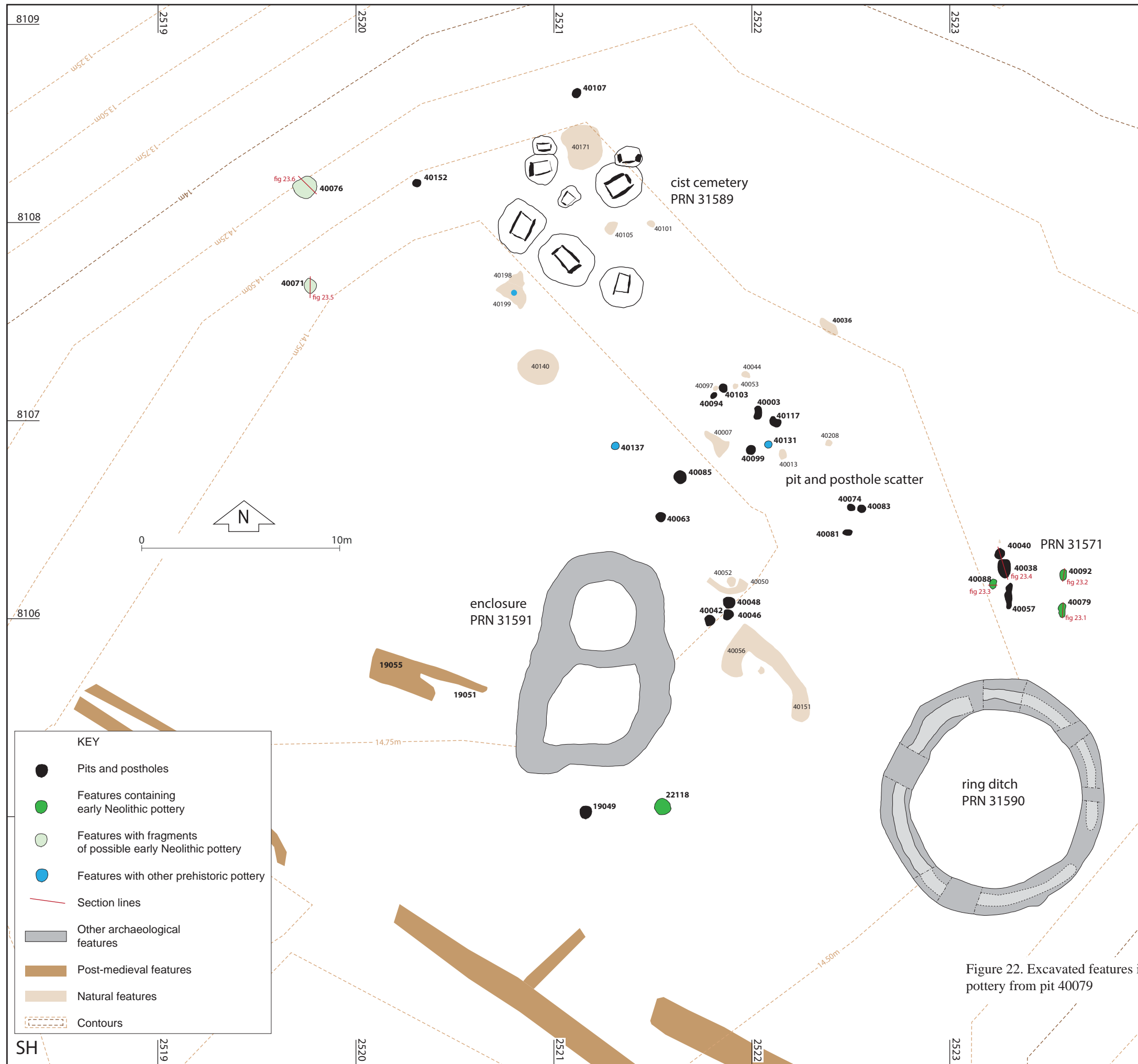
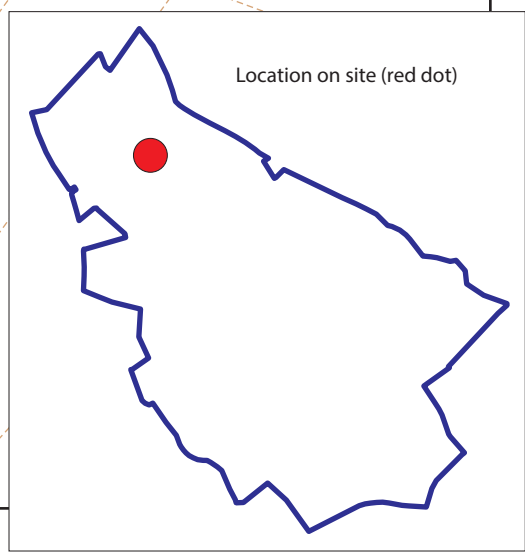

Figure 22. Excavated features in Area M with inset of pottery from pit 40079



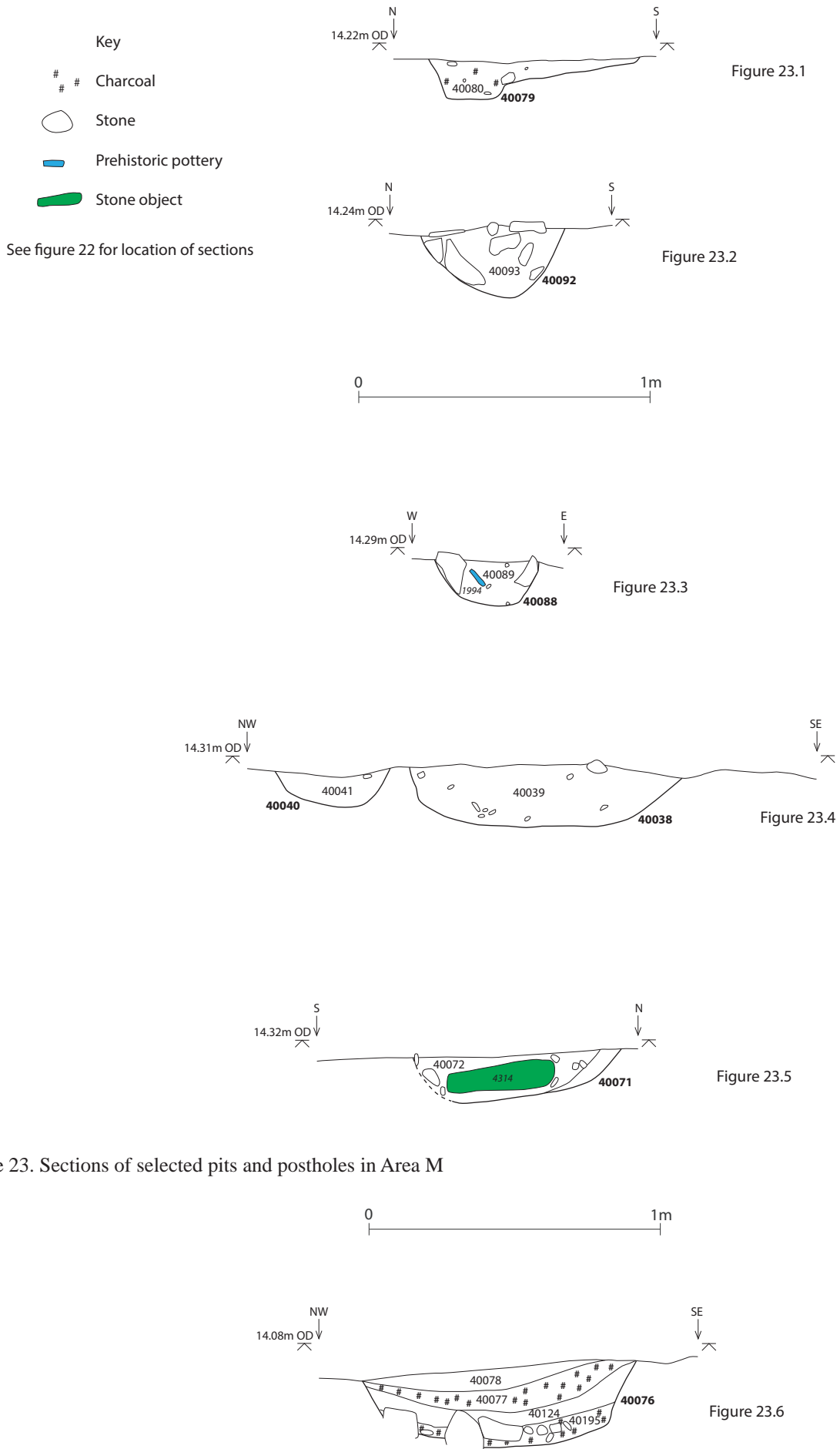
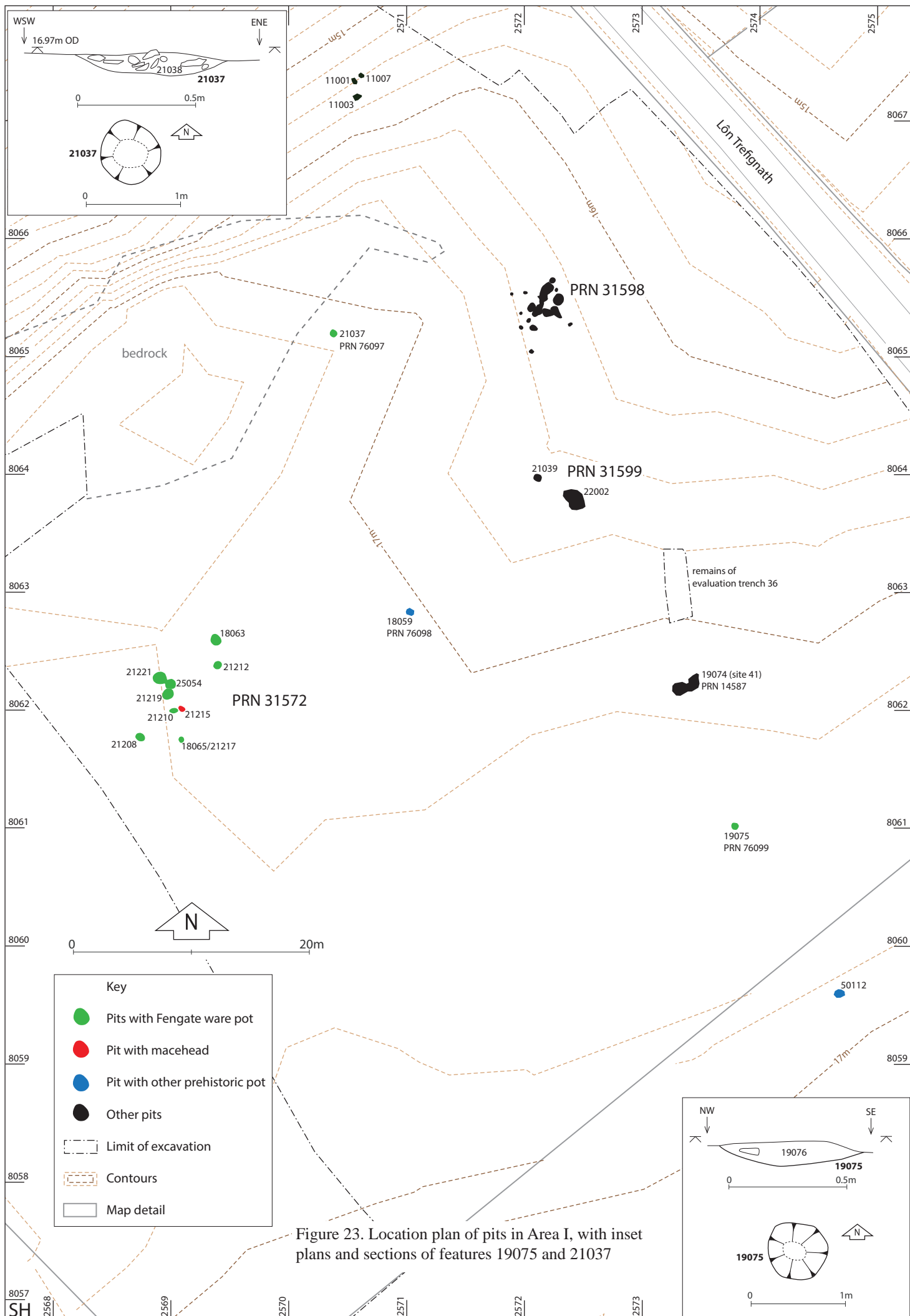
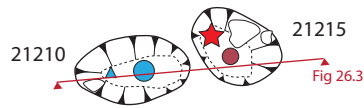
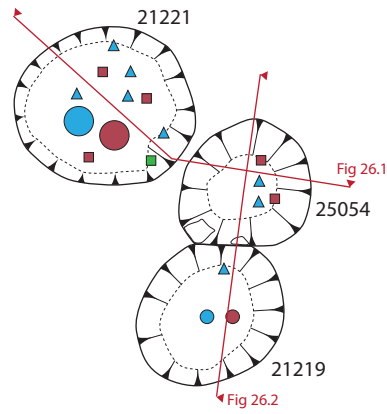
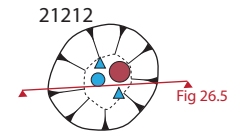
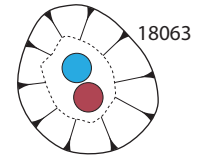

Figure 23. Sections of selected pits and postholes in Area M



2569

- Key
- | | | | |
|-------------------------|-----------------|--------------------------|-----------------|
| Finds located precisely | | Finds located by context | |
| ▲ Pottery | ● Pottery | ● Pottery | ● Pottery |
| ■ Knapped stone | ● Knapped stone | ● Knapped stone | ● Knapped stone |
| ■ Other worked stone | → Section line | | |
| ★ Hammer/macehead | △ Stone | | |



8062

8062

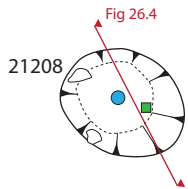
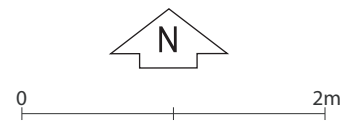
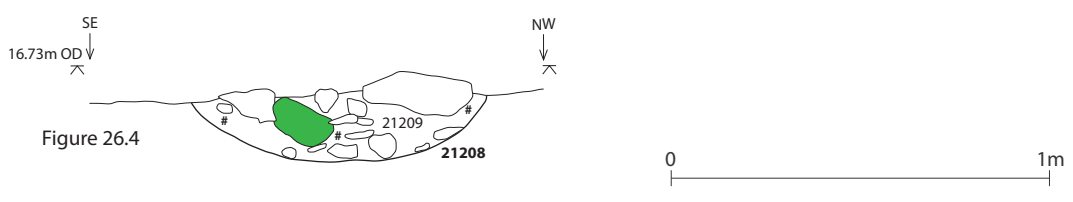
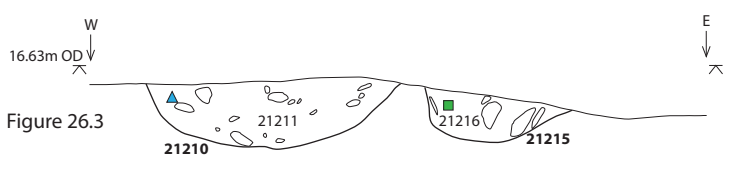
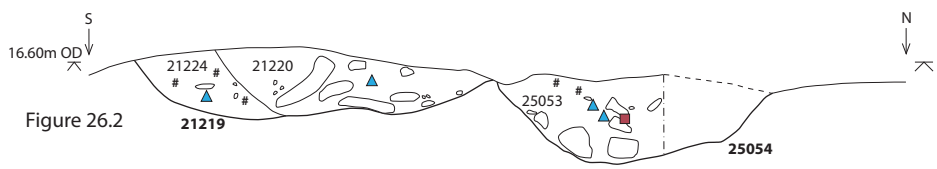
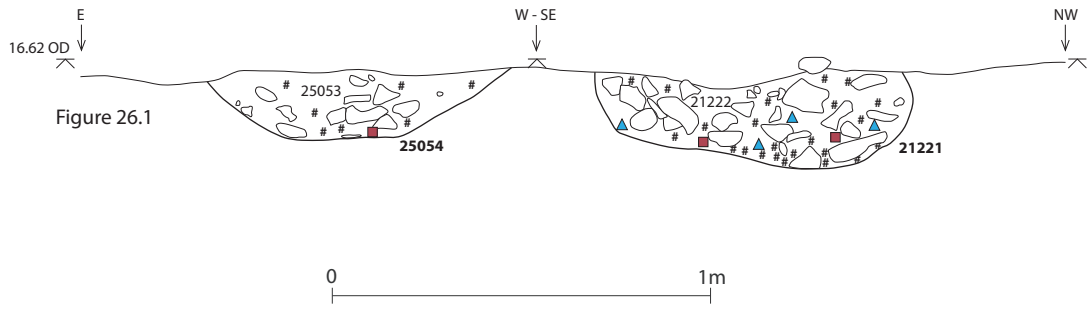

Figure 25. Plan of pit group PRN 31572 with finds distribution



2569



- Key
- ▲ Pottery
 - Knapped stone
 - Other worked stone
 - ## Charcoal
 - Stone

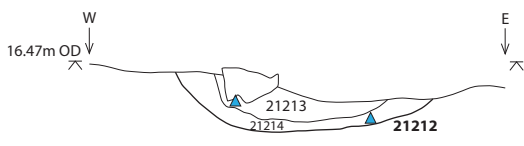

Figure 26.5

See figure 25 for location of sections

Figure 26. Sections of pits in group PRN 31572

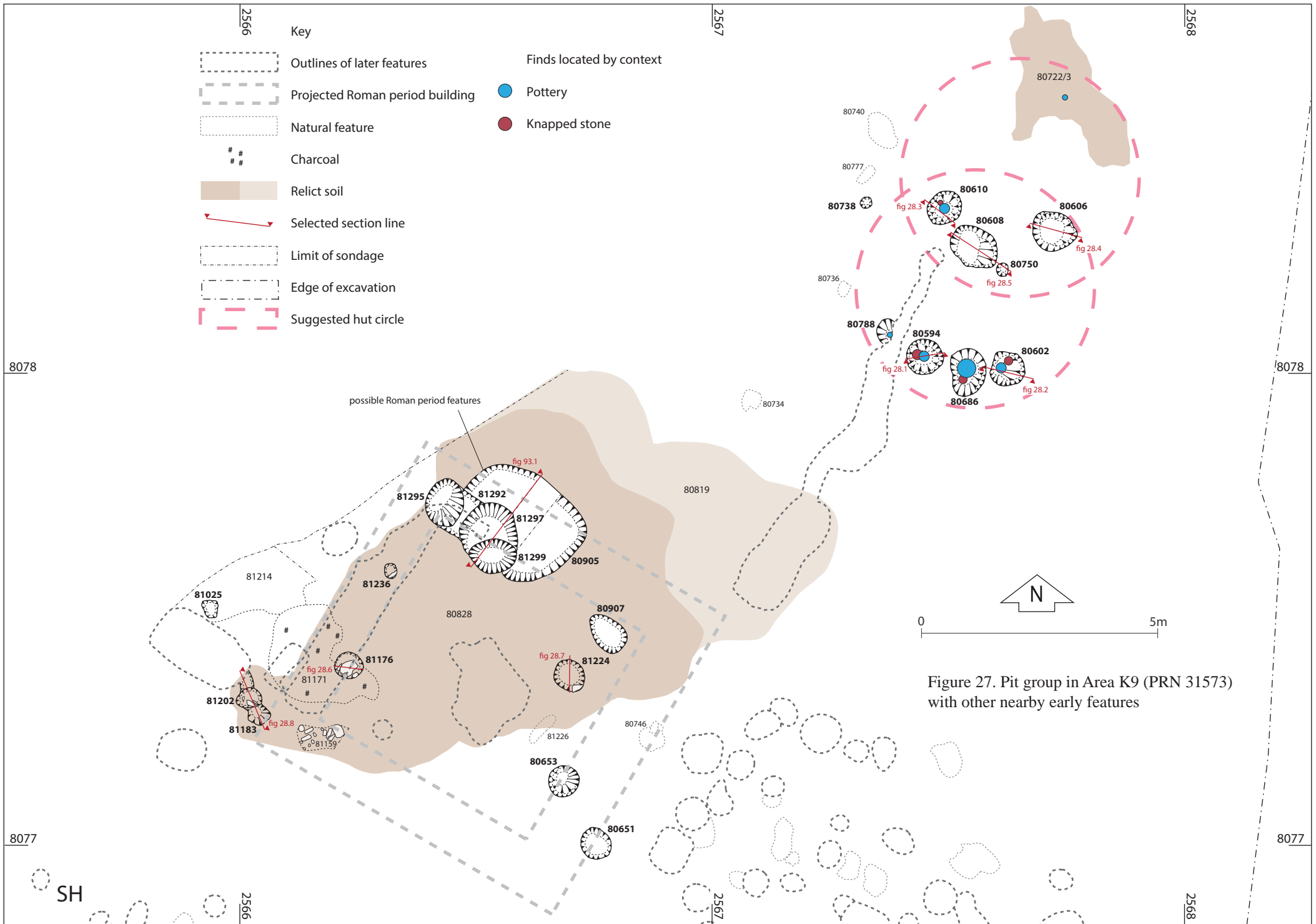

Figure 27. Pit group in Area K9 (PRN 31573) with other nearby early features

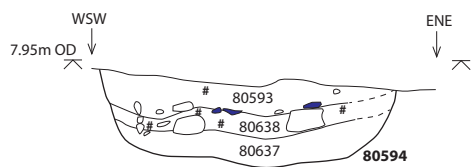

Figure 28.1

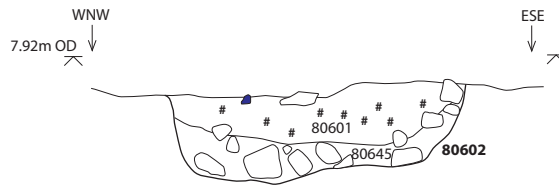

Figure 28.2

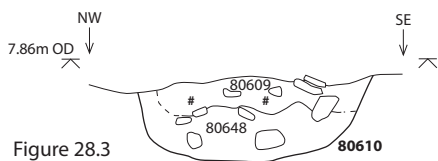

Figure 28.3



Figure 28.4

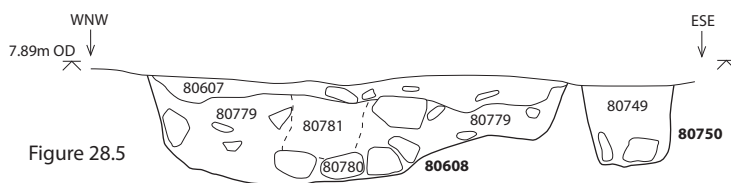

Figure 28.5

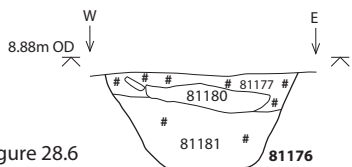

Figure 28.6



Figure 28.7



Key

Charcoal

Heat altered hearth lining

Stone



Figure 28.8

See figure 27 for location of sections

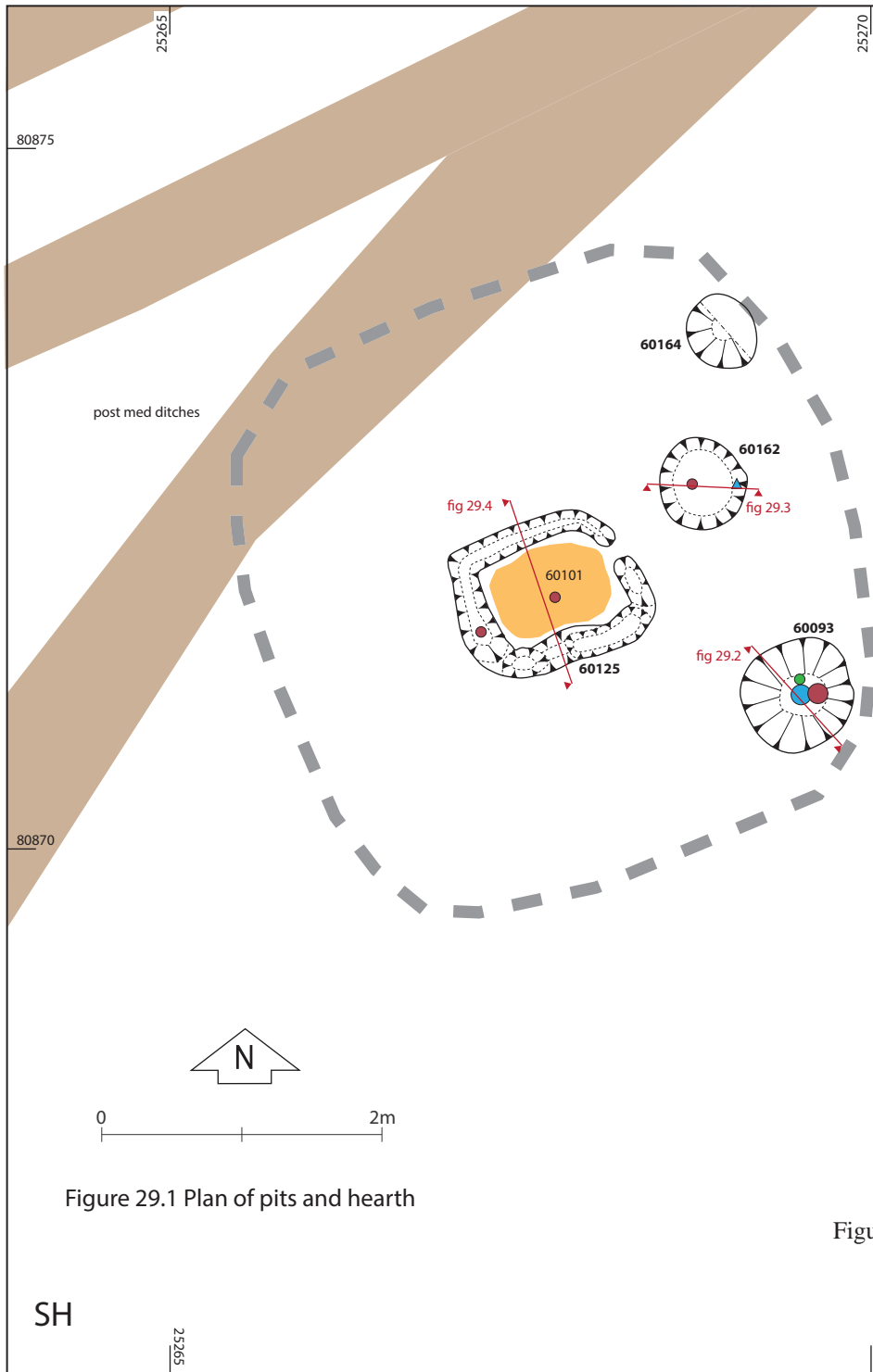

Figure 29.1 Plan of pits and hearth

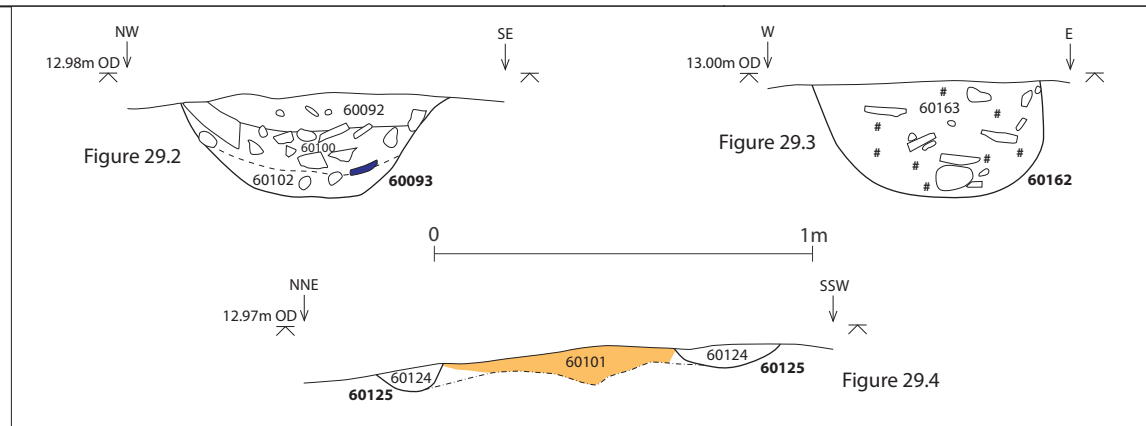
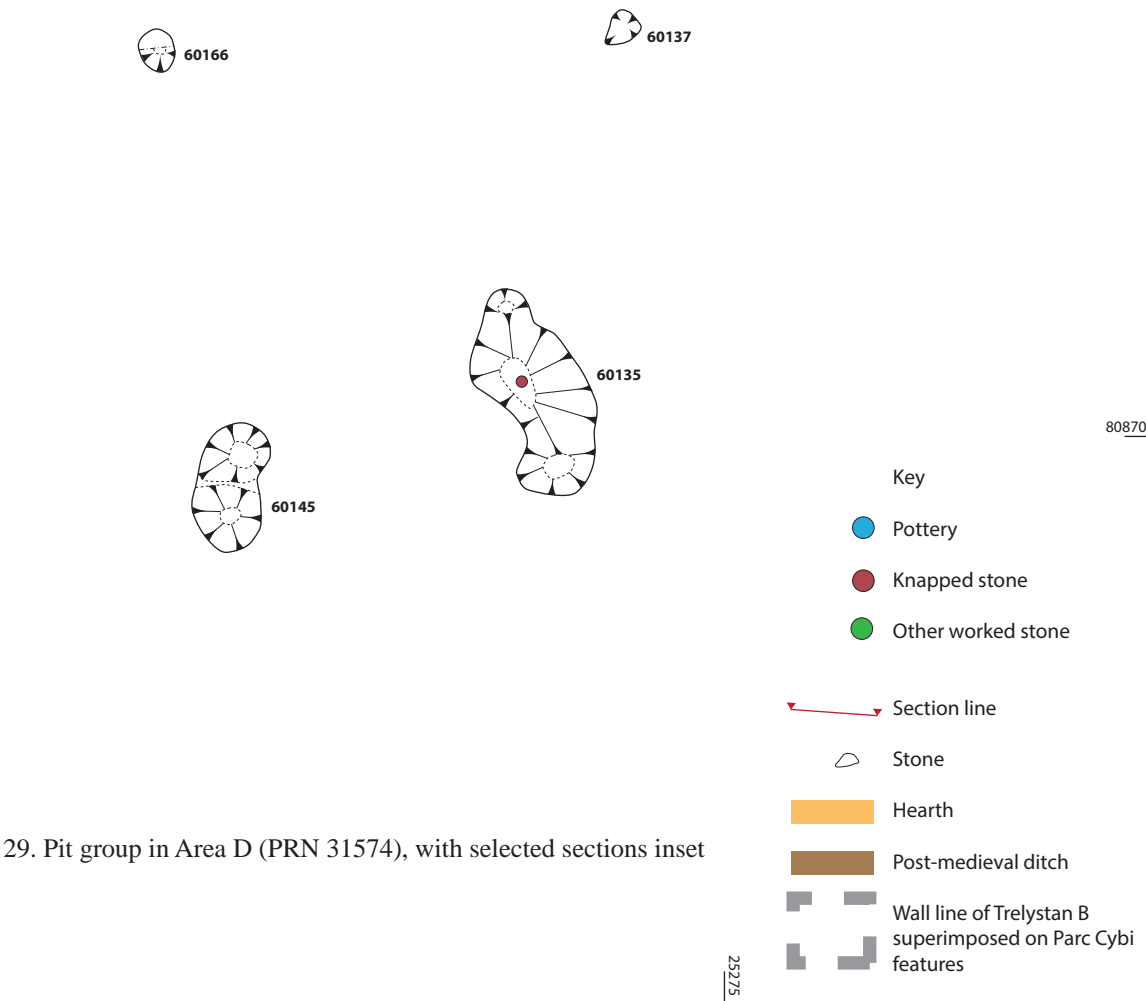

Figure 29. Pit group in Area D (PRN 31574), with selected sections inset



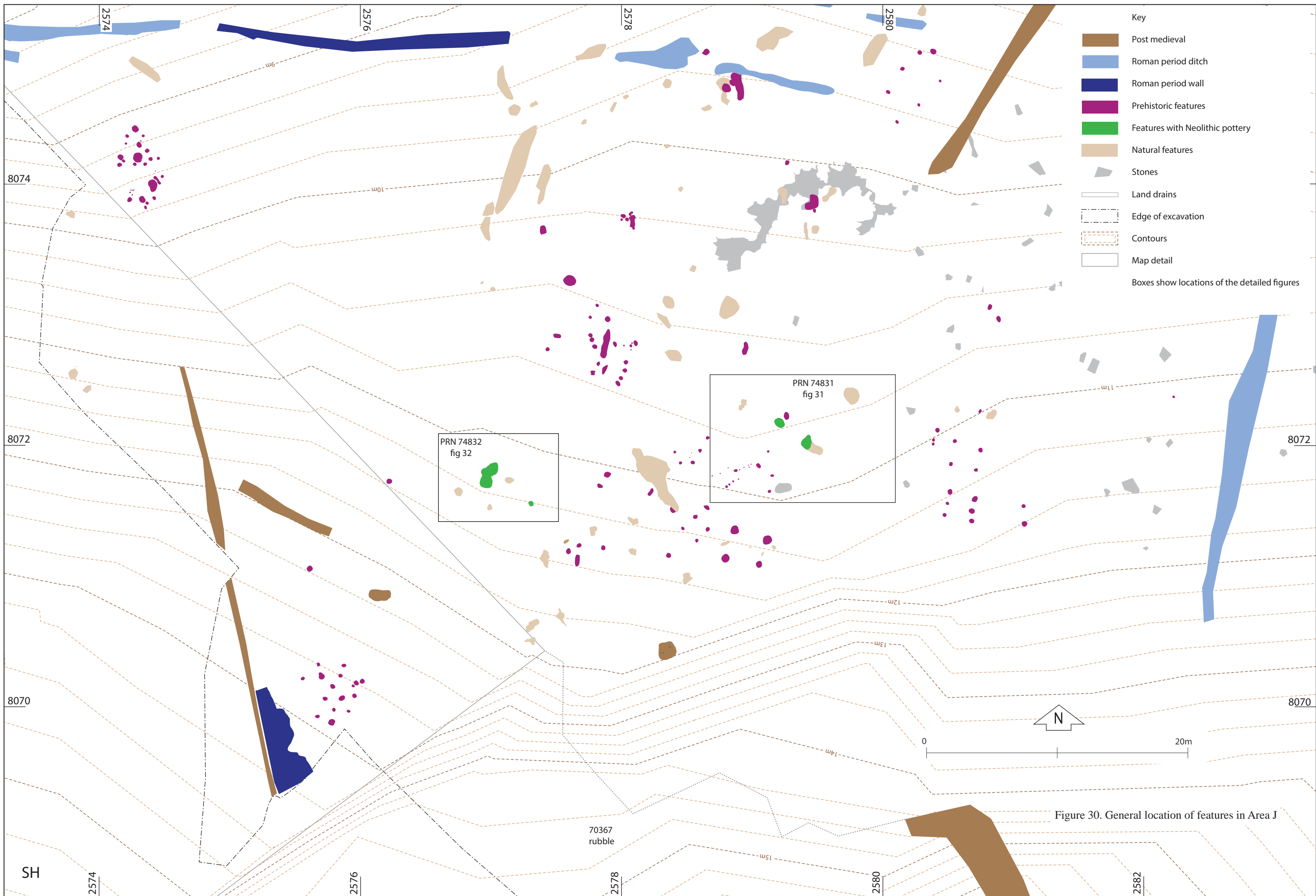
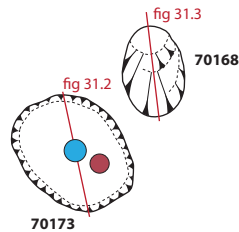

Figure 30. General location of features in Area J

- Key
- Natural features
 - Section line
 - Stone
 - ## Charcoal
 - Prehistoric pottery
 - Knapped stone
 - Other worked stone



70233



70173

70168

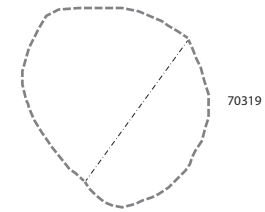

70319

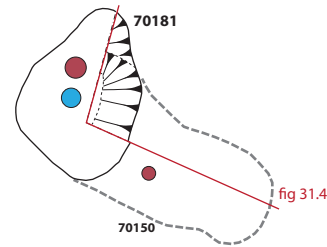
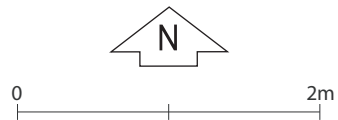

70181

70150

fig 31.4

Figure 31. Plan and sections of pits 70168, 70173 and 70181 (PRN 74831)

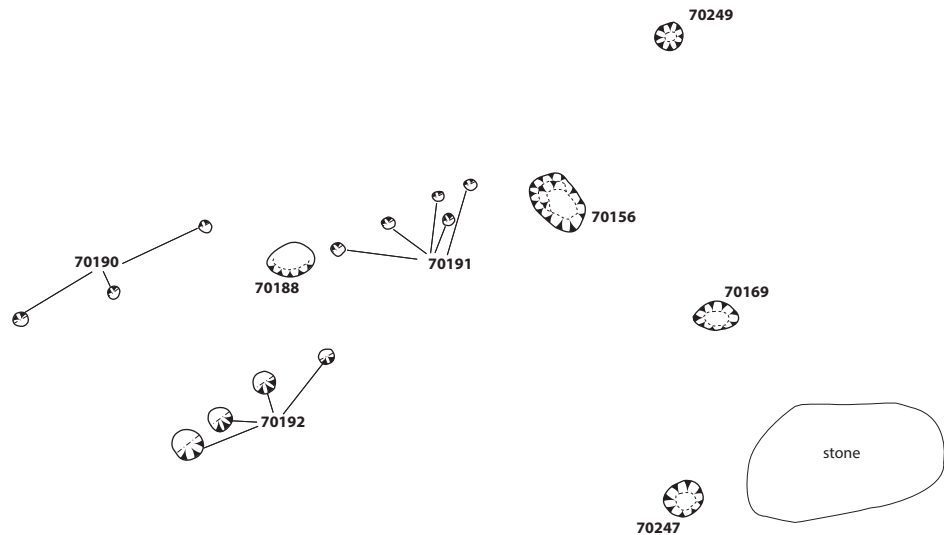

Figure 33.1

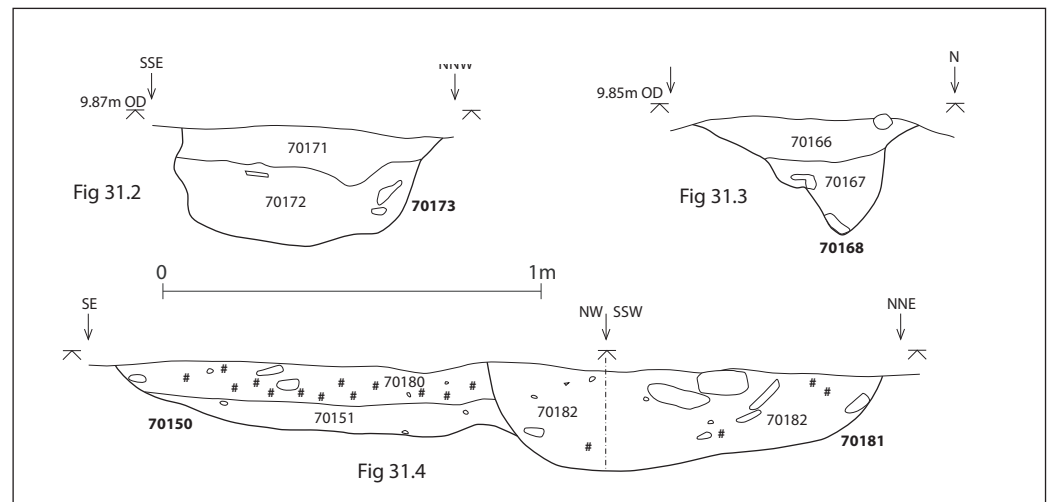

Fig 31.2

Fig 31.3

Fig 31.4

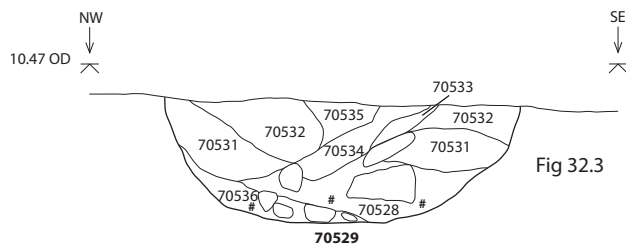
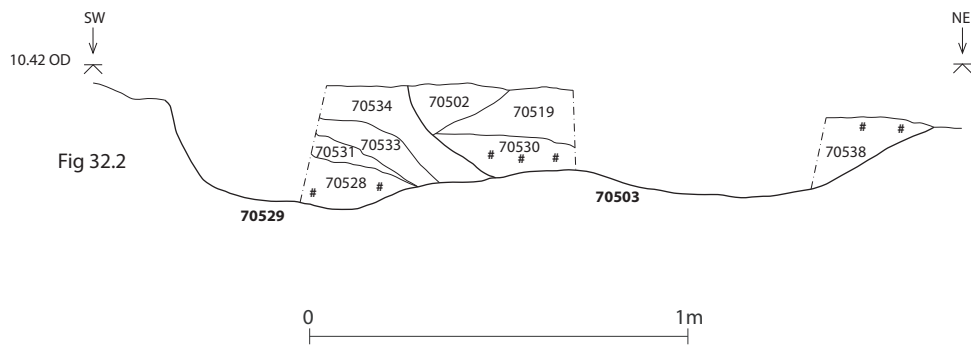
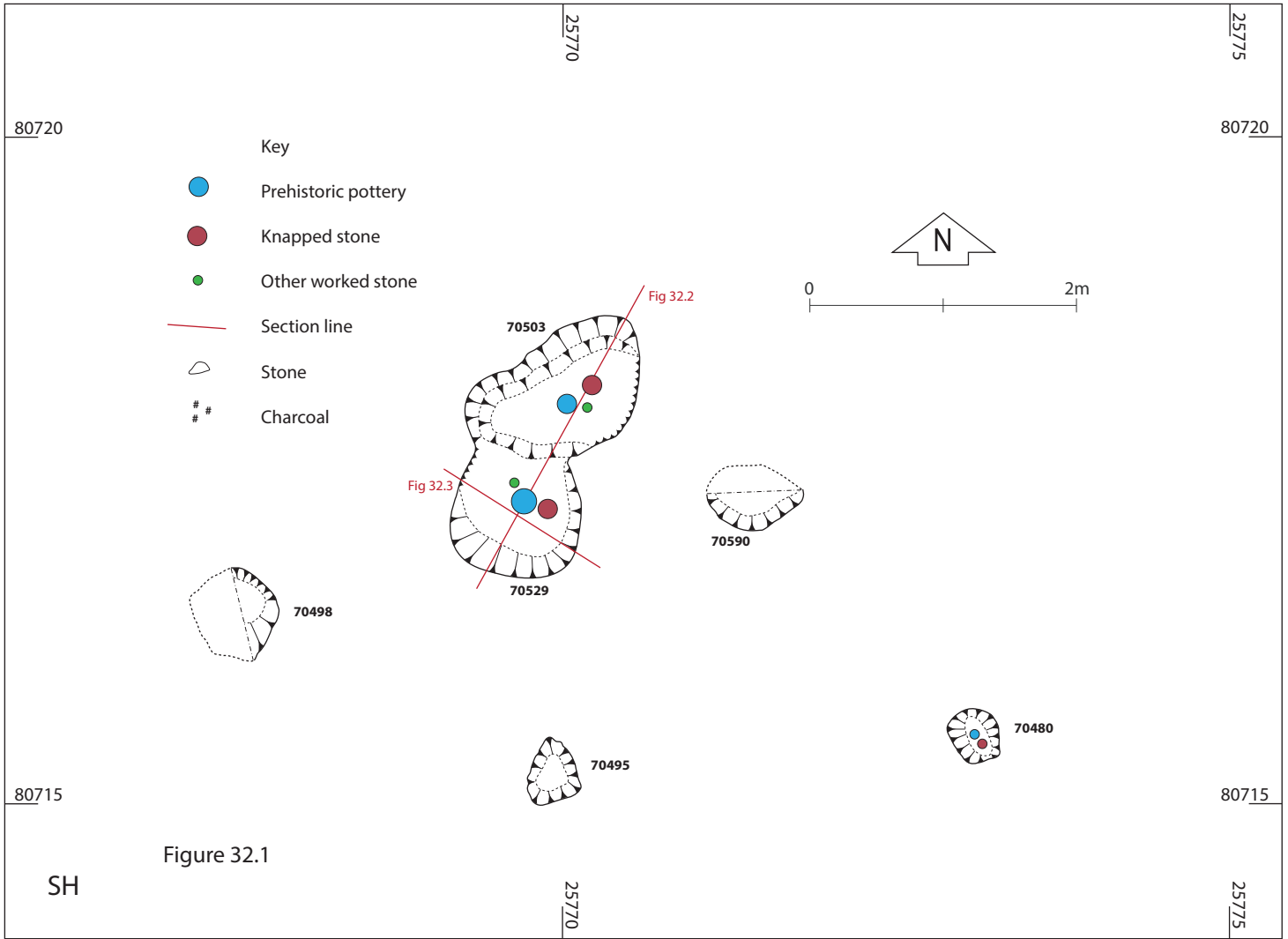

Figure 32. Plan and sections of pits 70529 and 70503 (PRN 74832)

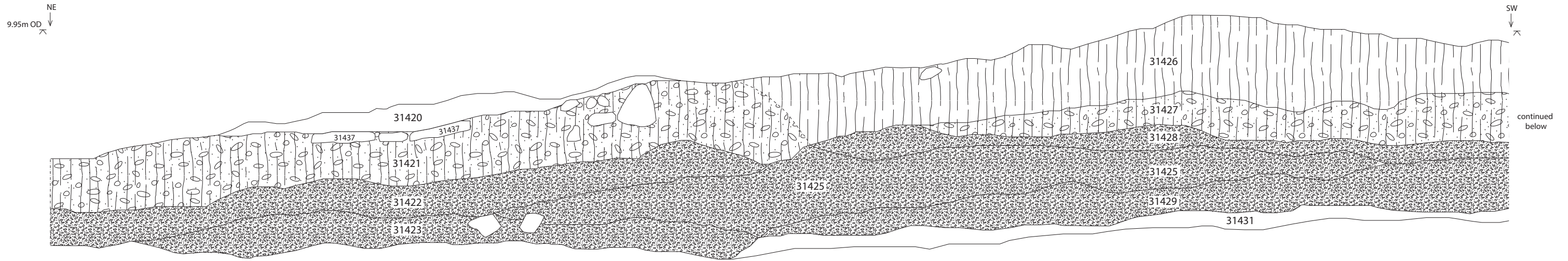

Figure 33.1

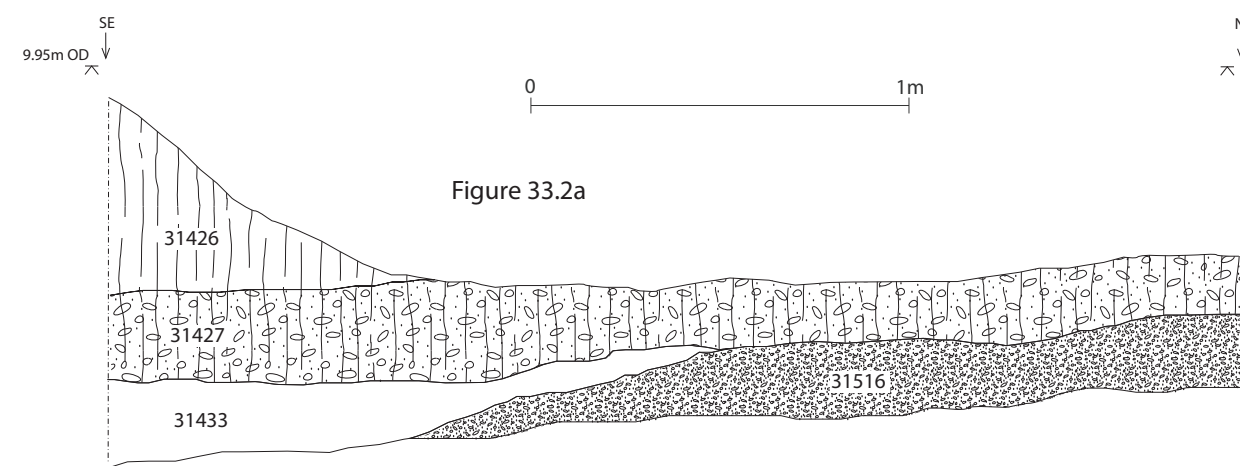
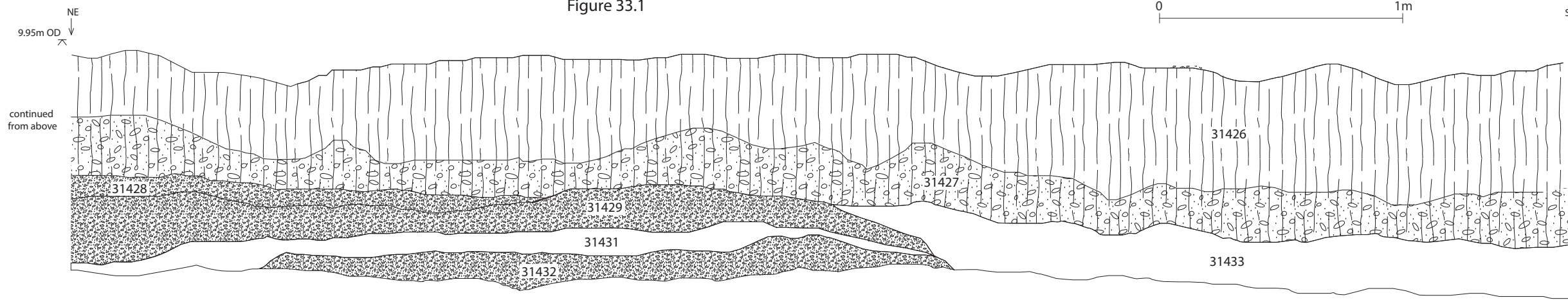

Figure 33.2a

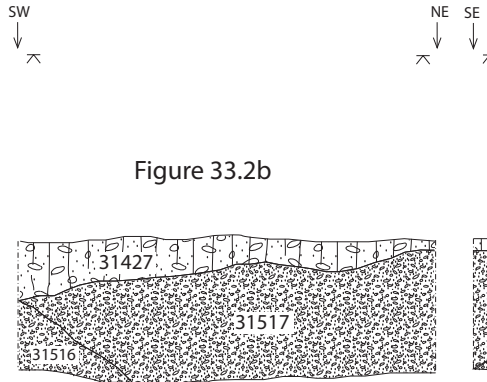

Figure 33.2b

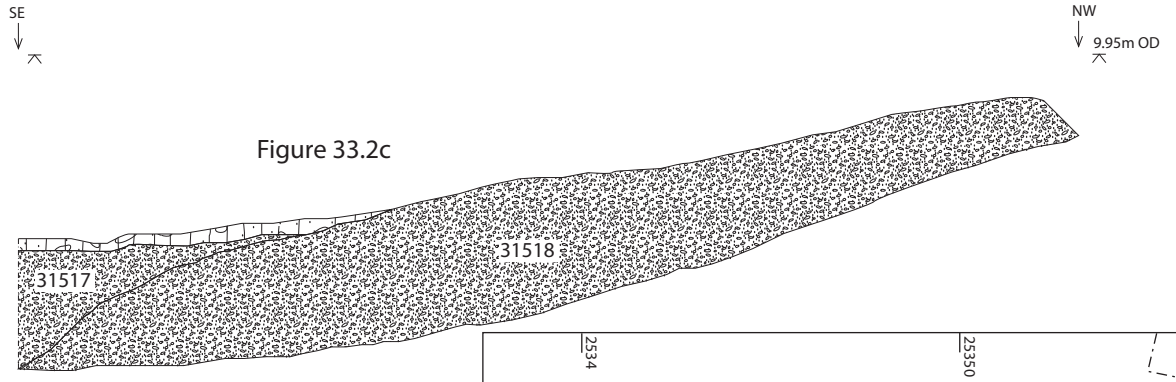

Figure 33.2c

- Key
- Bank material
 - Mixed bank and burnt mound material
 - Burnt mound
 - On inset
 - Post-medieval wall
 - Burnt mound features
 - Limit of excavation
 - Section lines
 - Approximate extent of burnt mound

Figure 33. Sections of burnt mound PRN 31582 with inset showing extent of mound and location of main sections

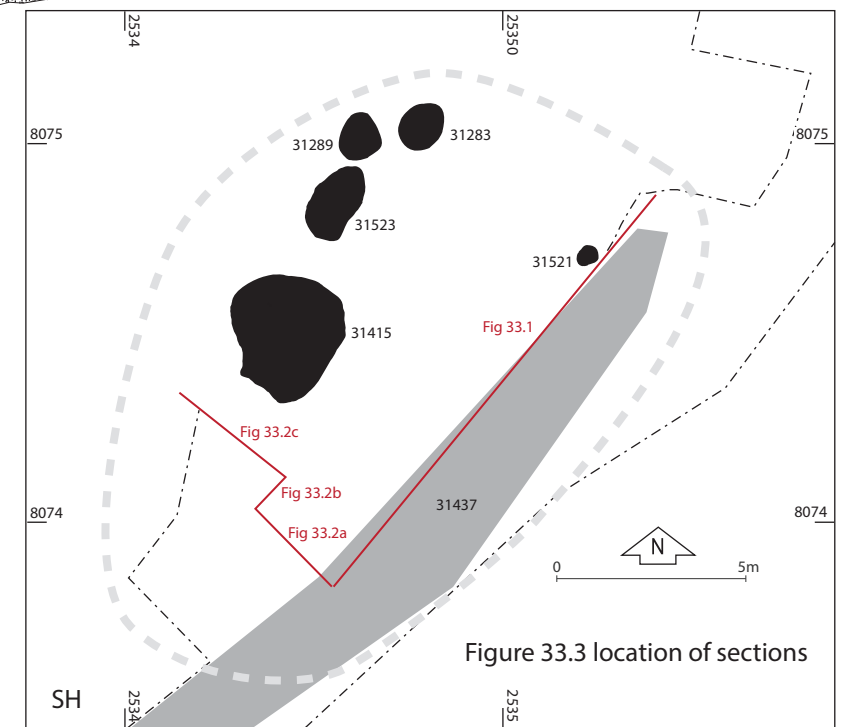

Figure 33.3 location of sections

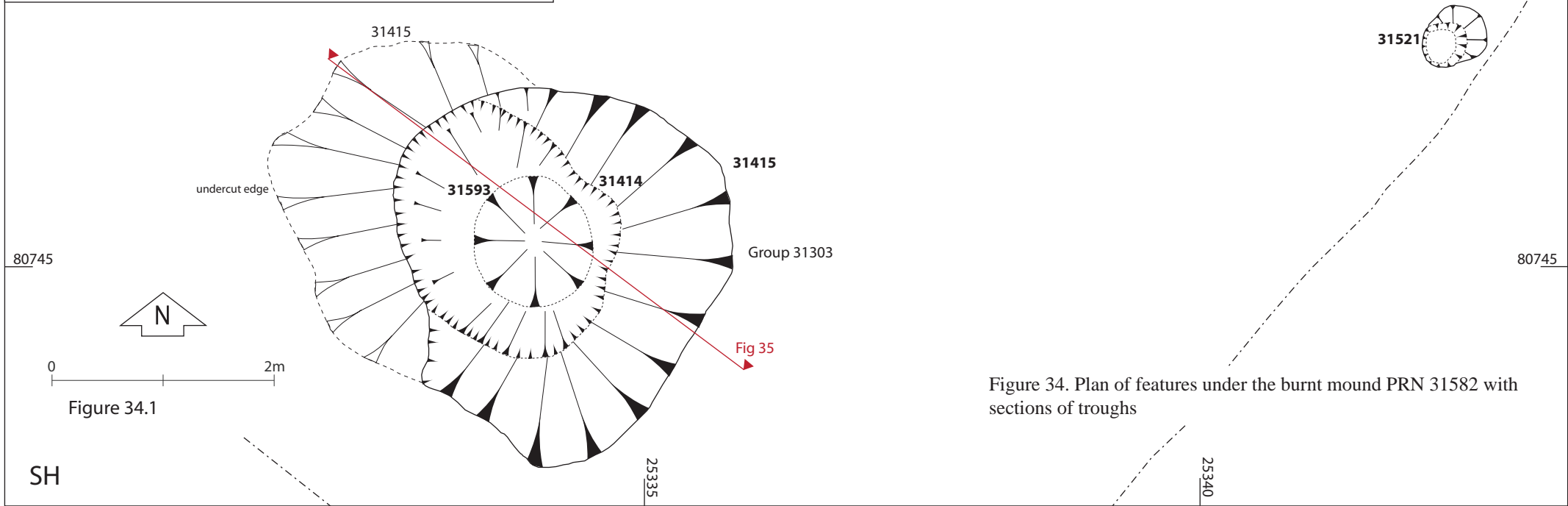
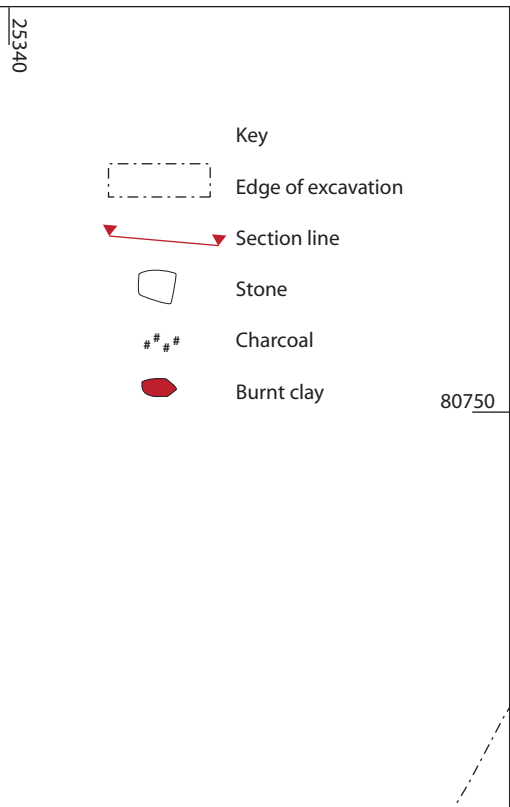
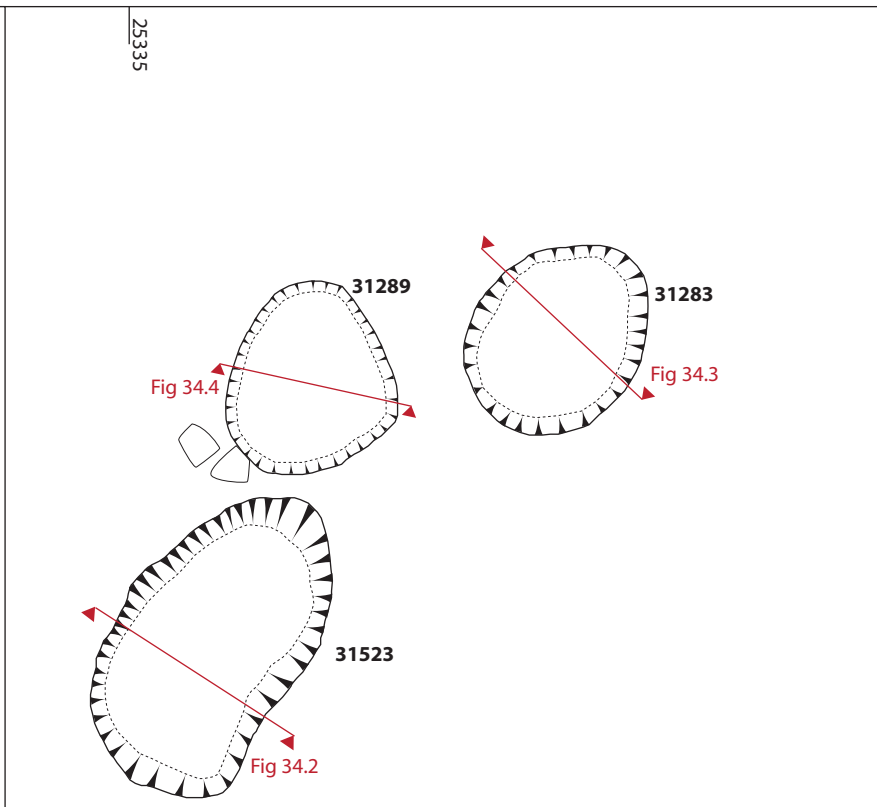
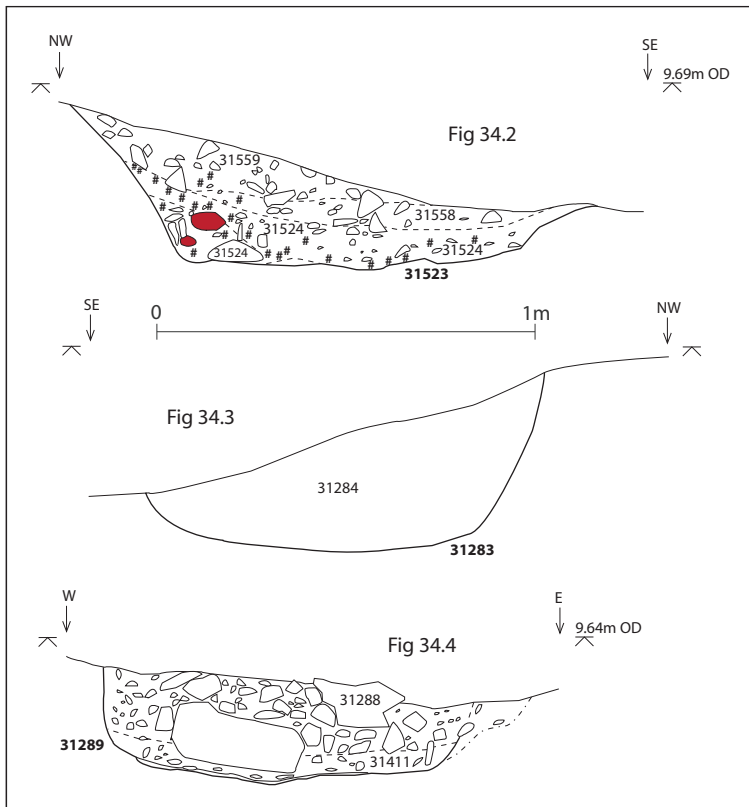

Figure 34. Plan of features under the burnt mound PRN 31582 with sections of troughs

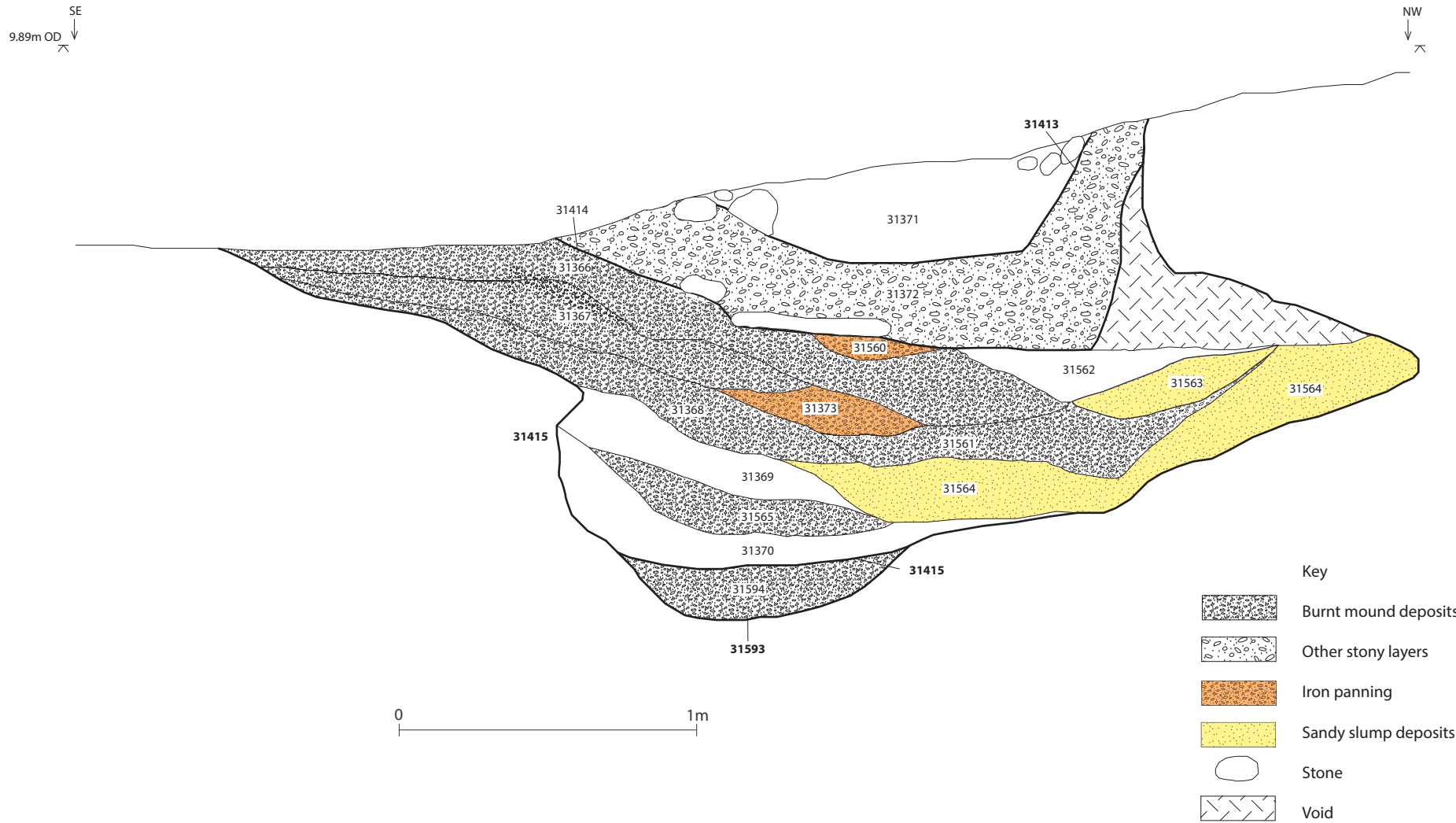

Figure 35. Section through recut well (group 31303)

See figure 34 for location of section

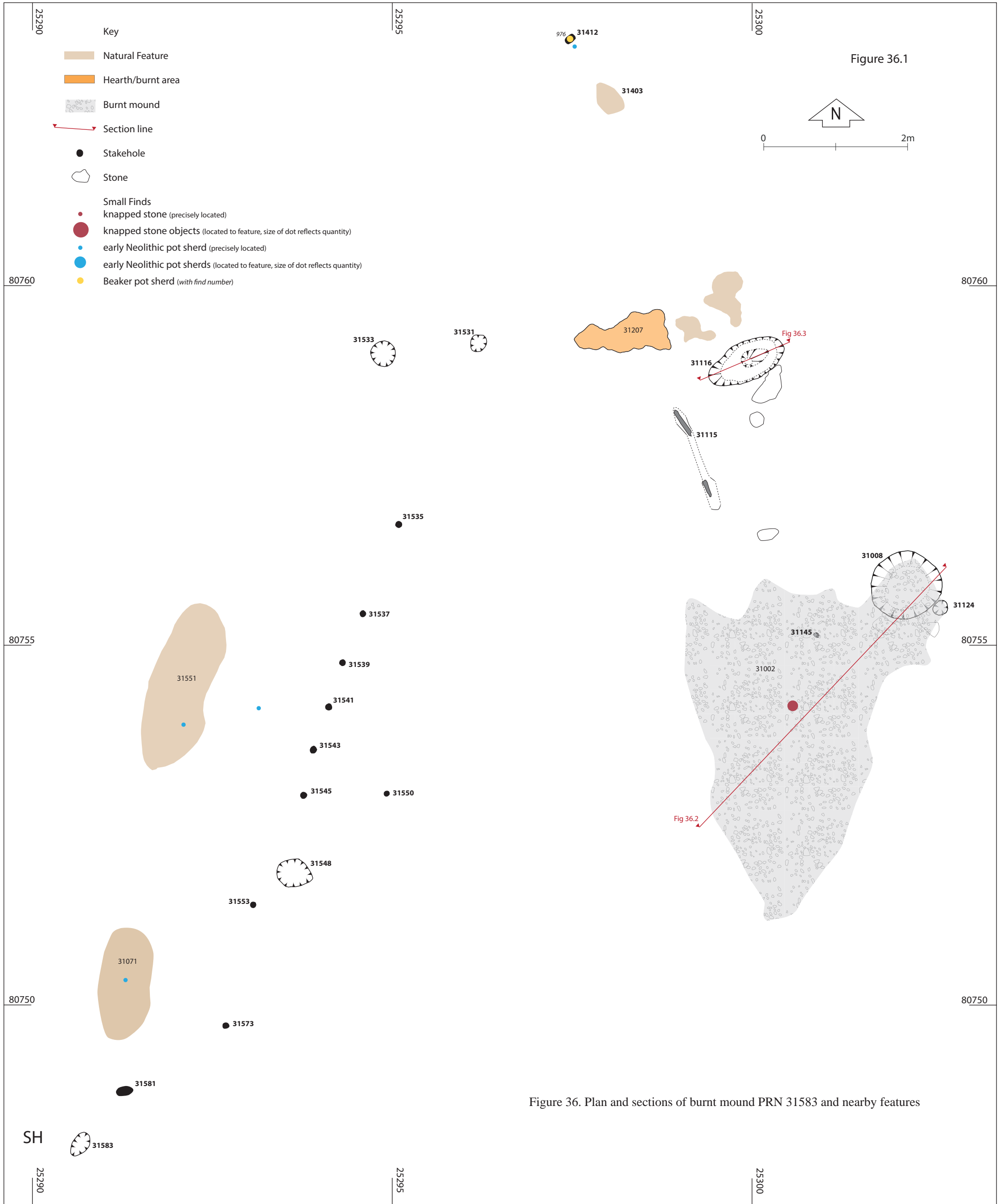
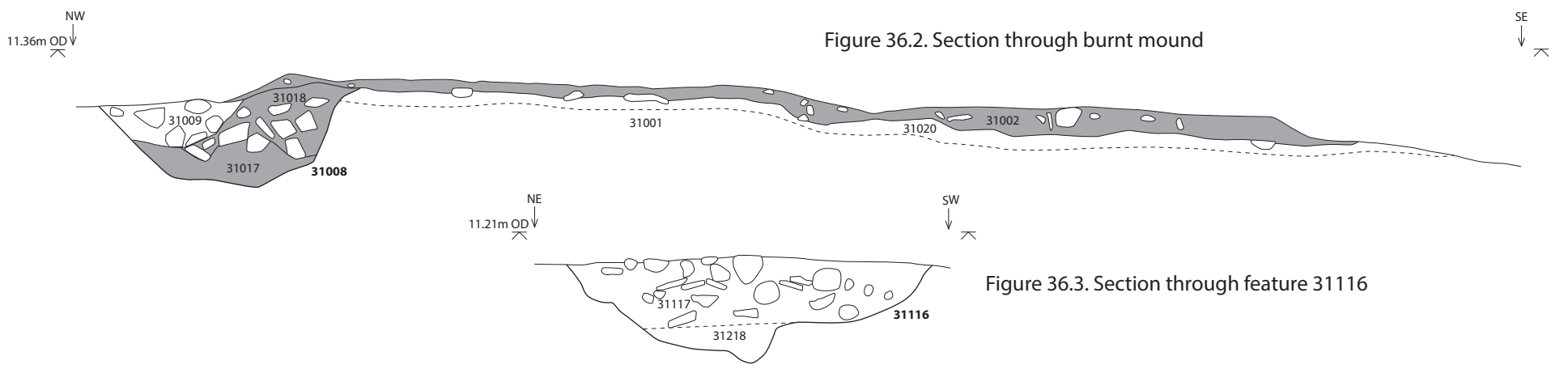
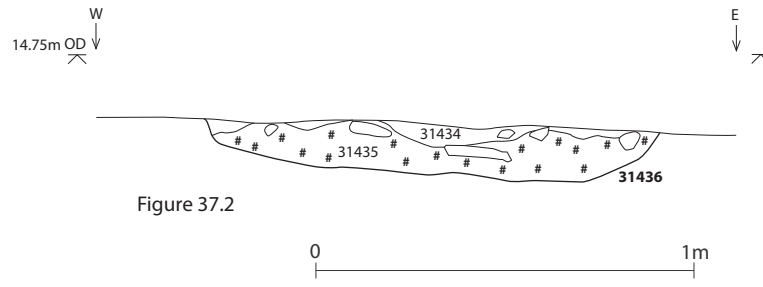
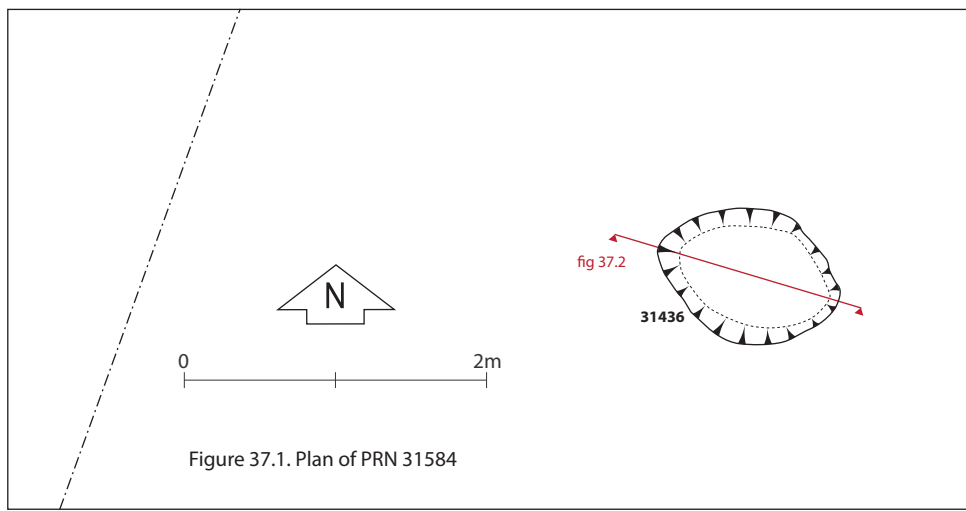

Figure 36. Plan and sections of burnt mound PRN 31583 and nearby features



- Key
- Post-medieval ditch
 - Limit of excavation
 - Section line
 - Stone
 - Charcoal
 - Prehistoric pot
 - Knapped stone

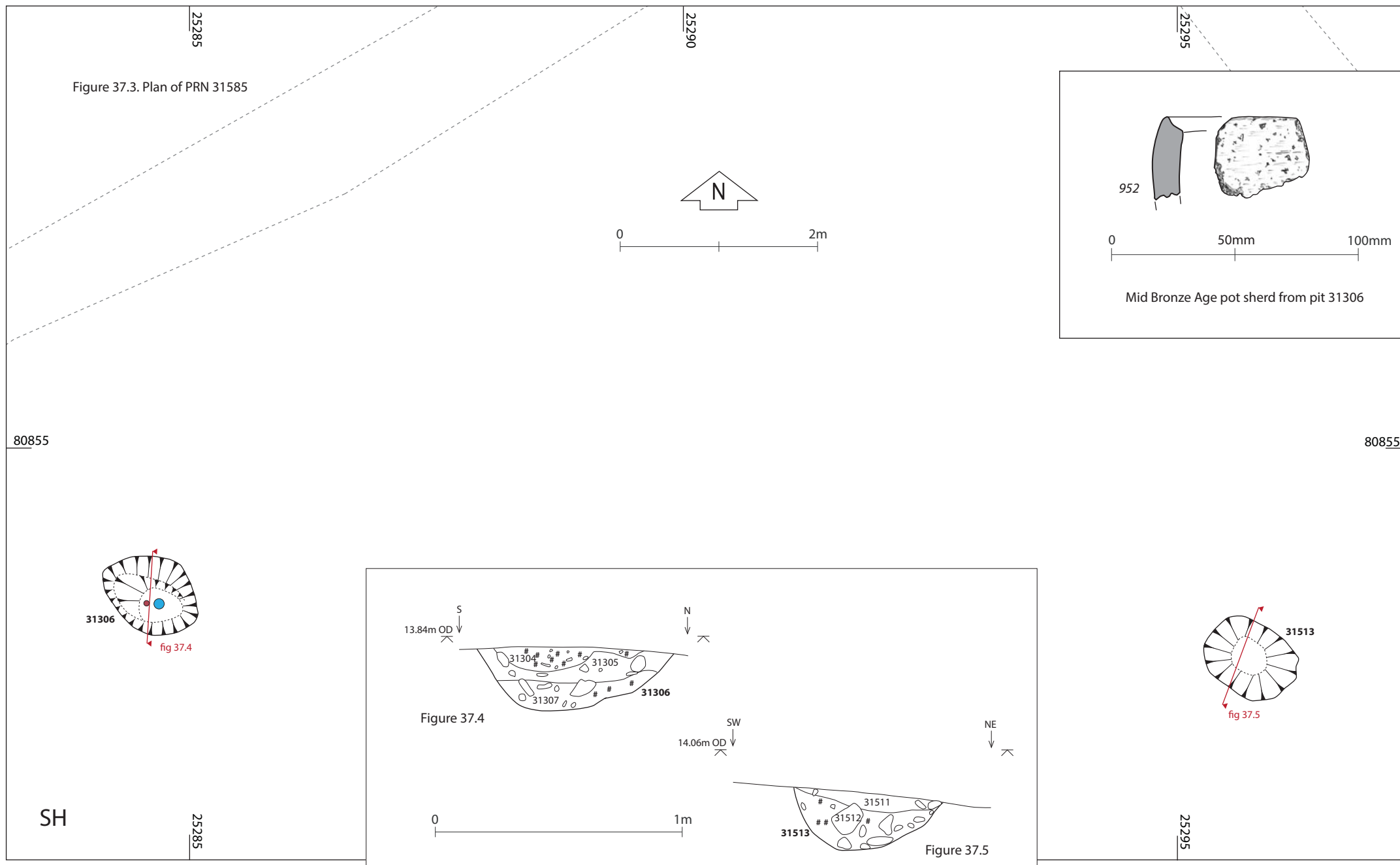
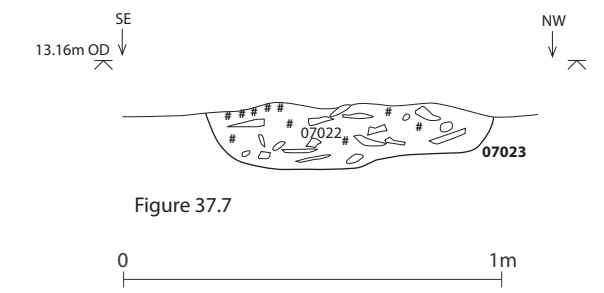
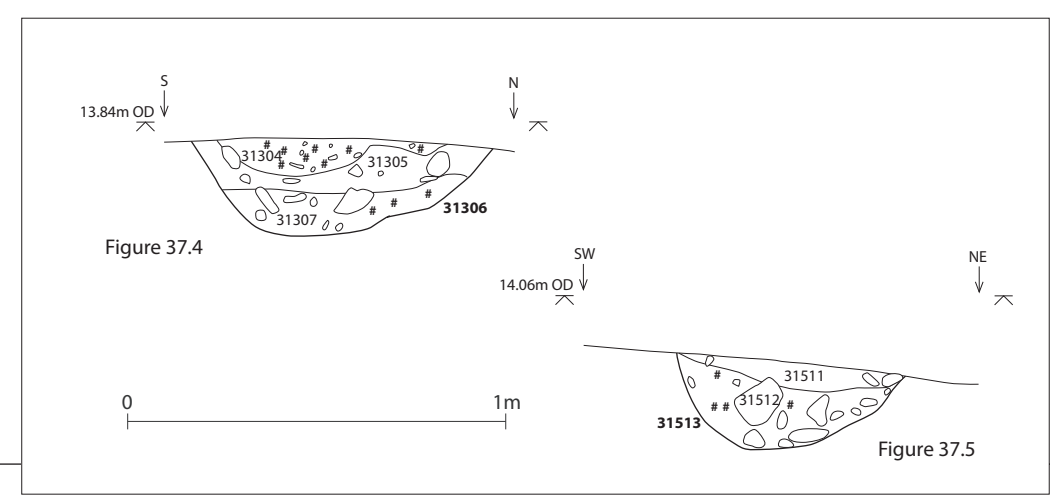
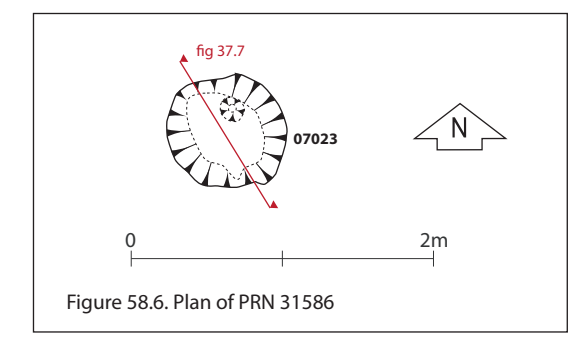

Figure 37. Plans and sections of earth ovens PRN 31584, 31585 and 31586



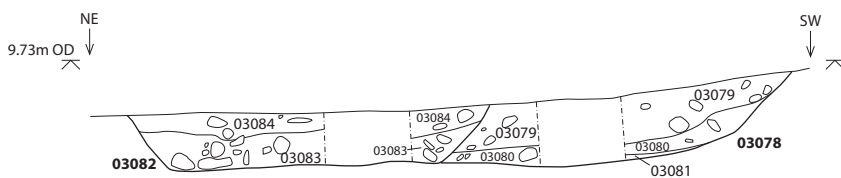
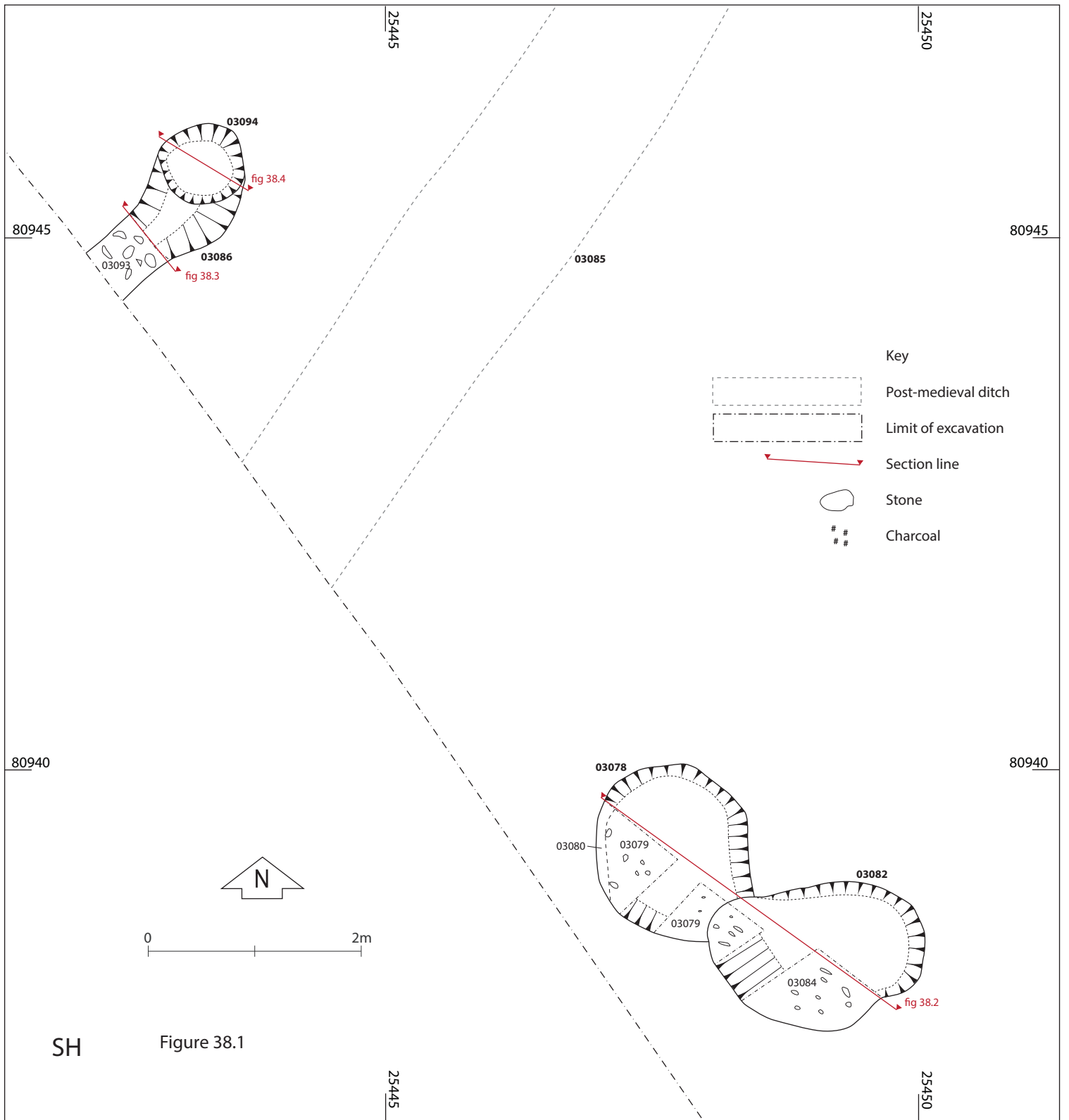

Figure 38.2

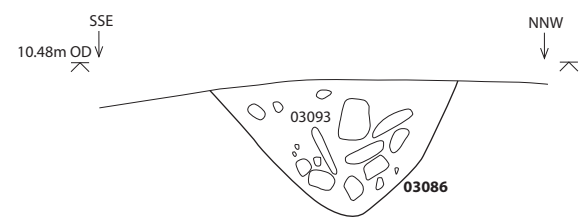

Figure 38.3

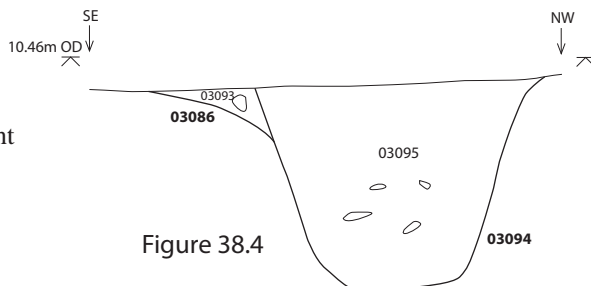

Figure 38.4

Figure 38. Plan and sections of possible burnt mound pits PRN 31587

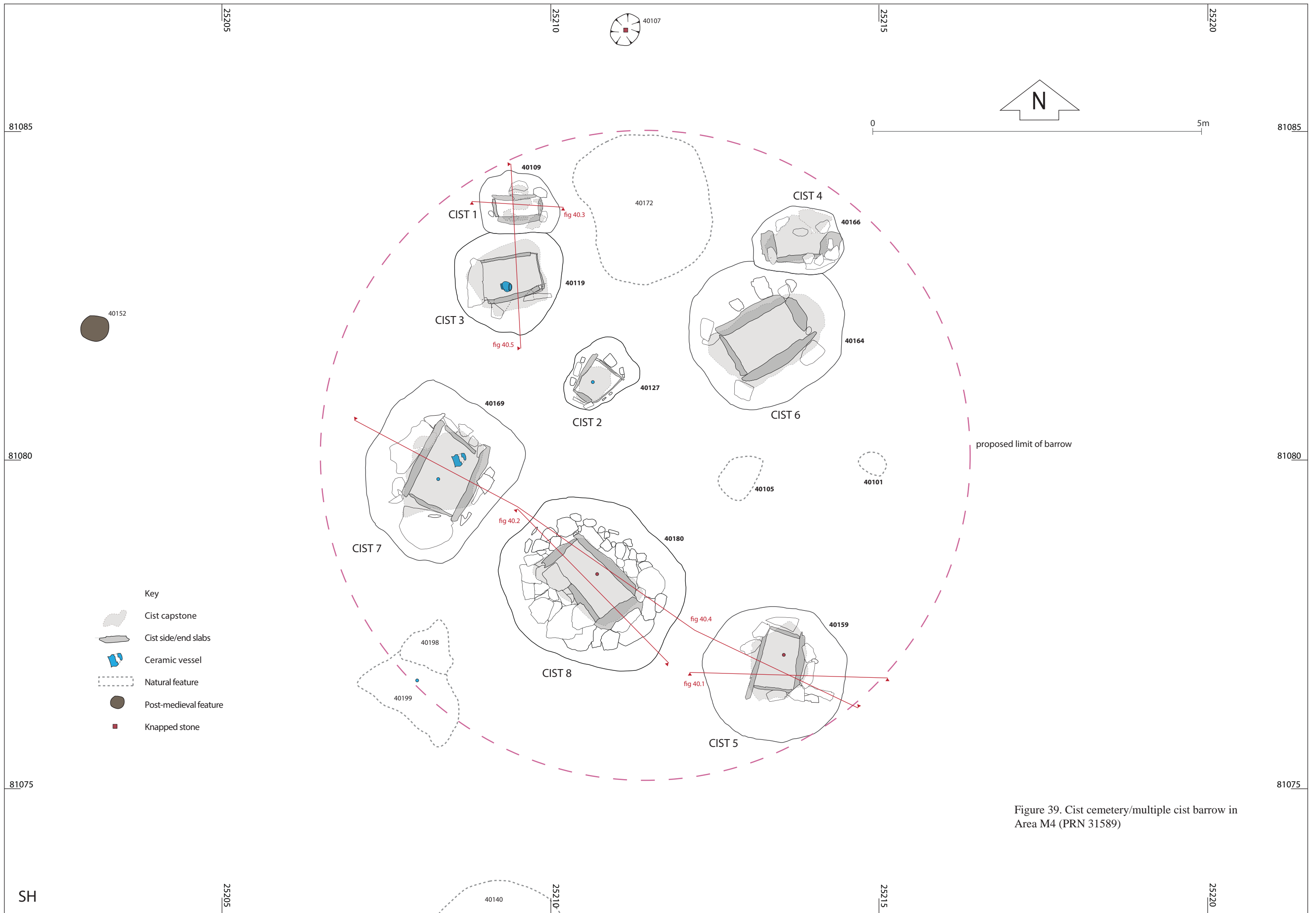

Figure 39. Cist cemetery/multiple cist barrow in Area M4 (PRN 31589)

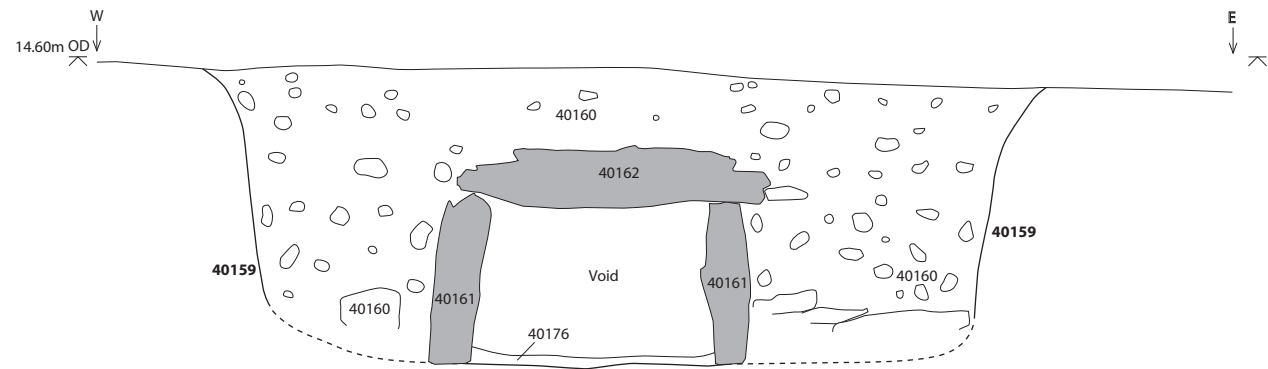
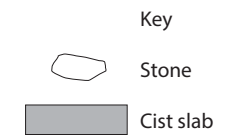

Figure 40.1 Section of cist 5



See figure 39 for location of sections

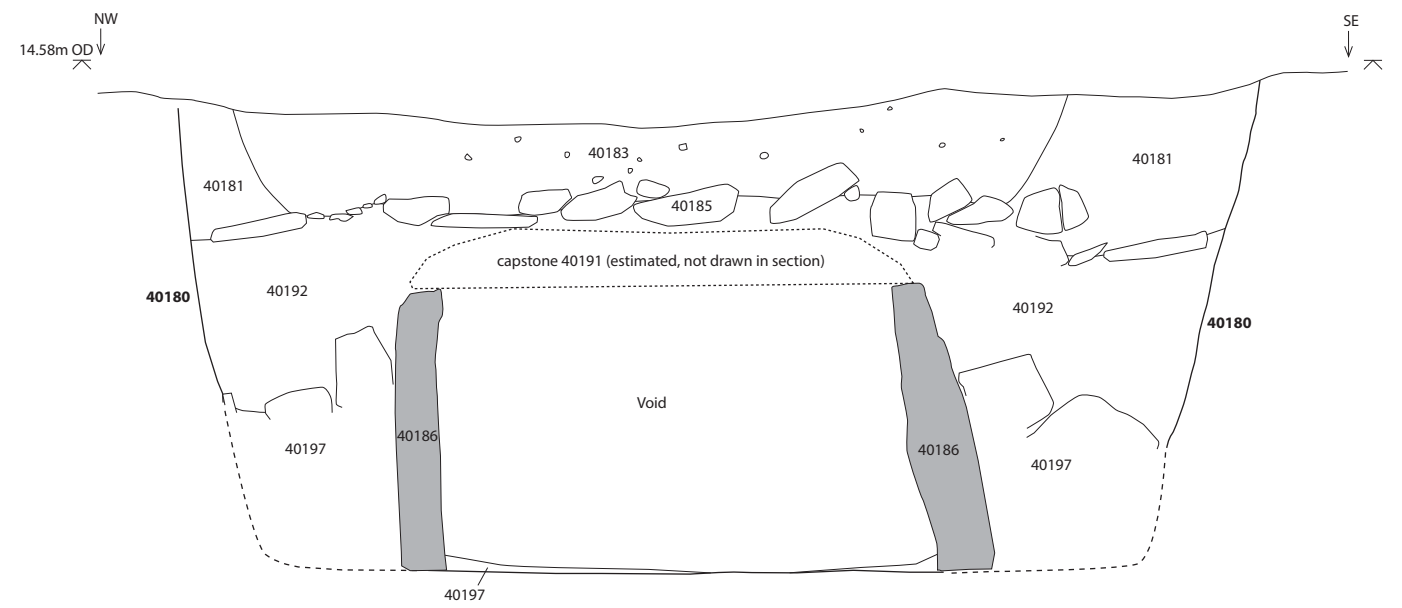

Figure 40.2. Section of Cist 8 reconstructed from two partial sections

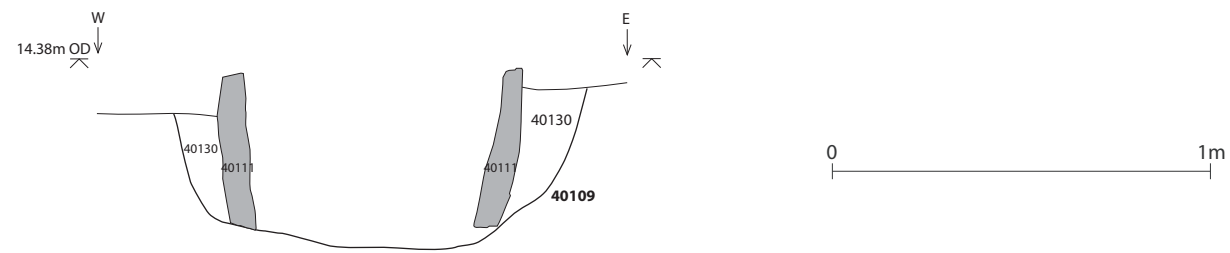

Figure 40.3 Section of cist 1

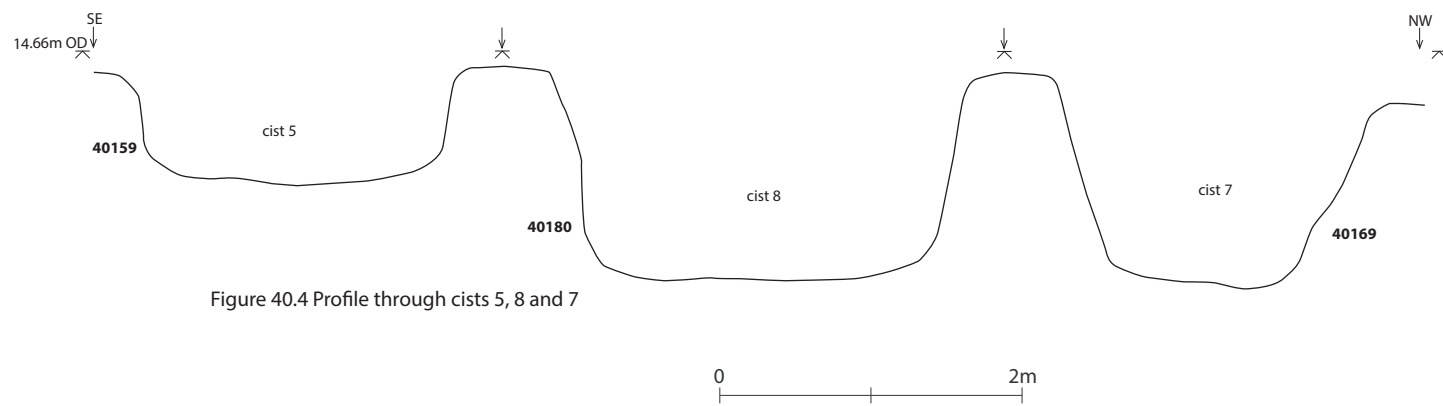

Figure 40.4 Profile through cists 5, 8 and 7

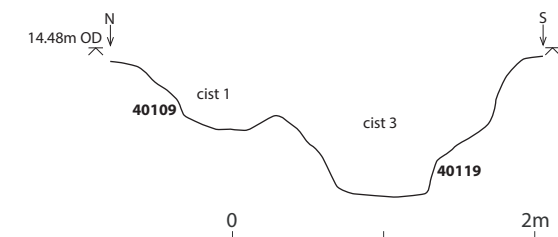

Figure 40.5 Profile through cists 1 and 3

Figure 40. Selected sections and profiles through the cists

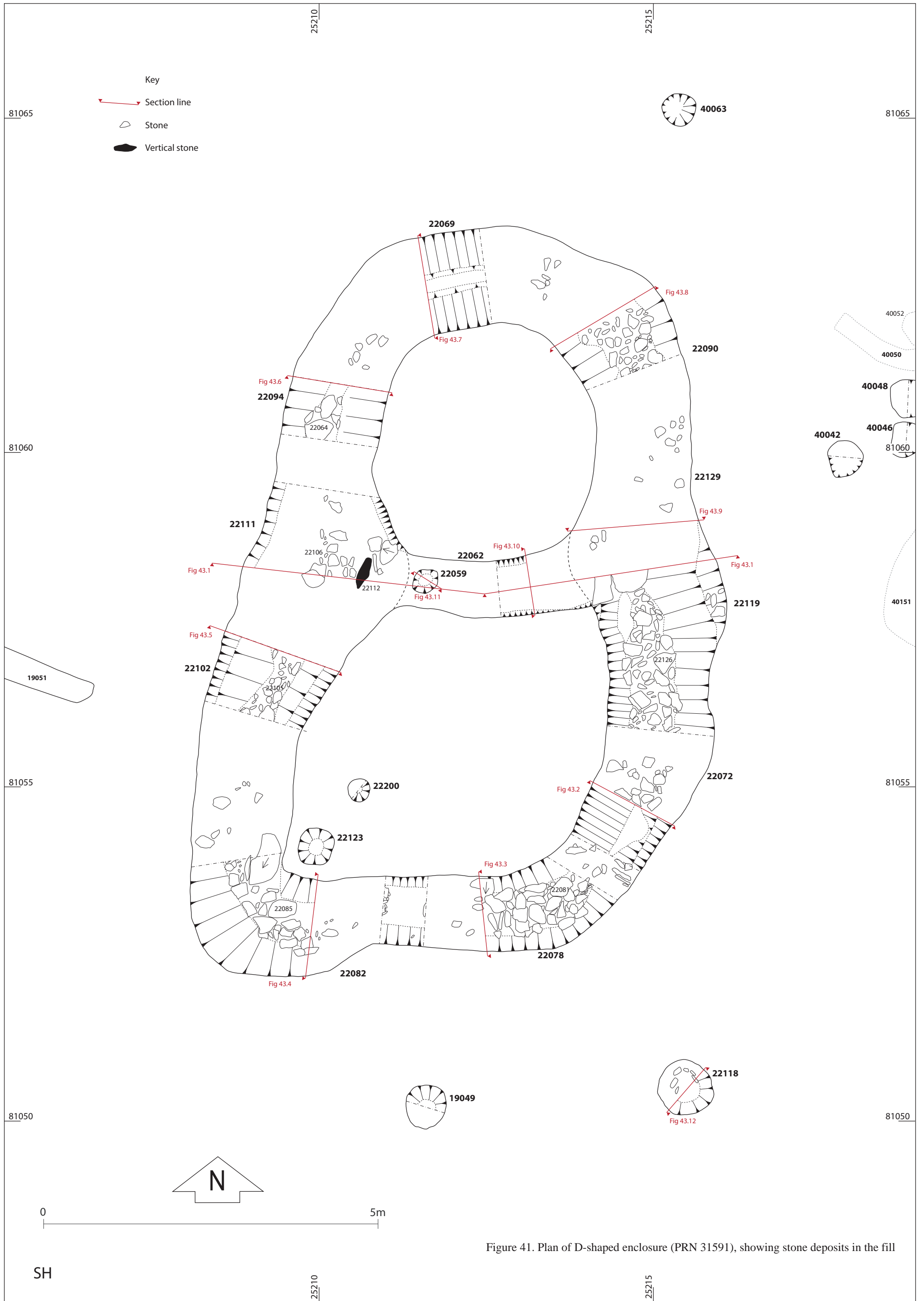
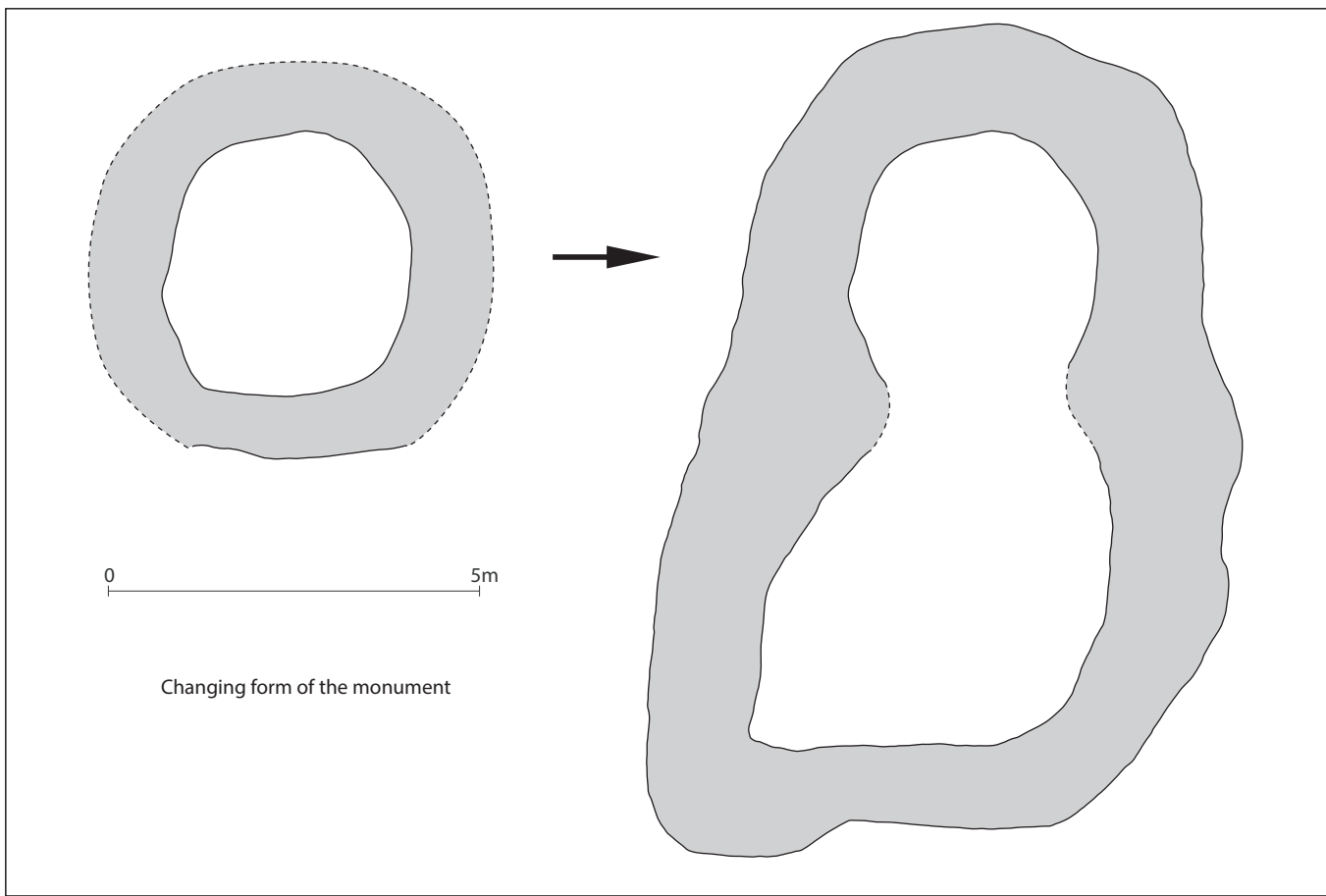

Figure 41. Plan of D-shaped enclosure (PRN 31591), showing stone deposits in the fill



25215



81065

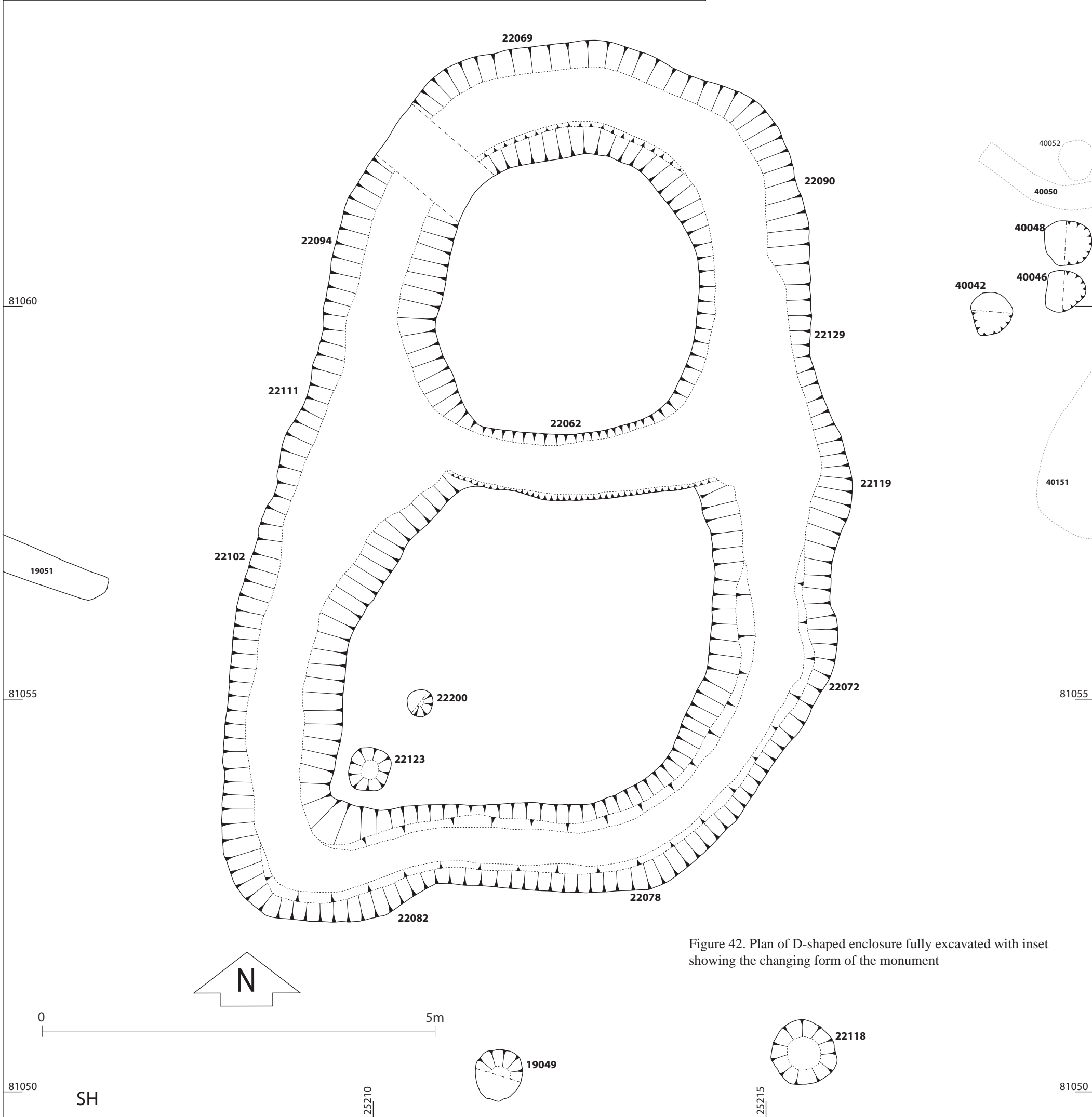

Figure 42. Plan of D-shaped enclosure fully excavated with inset showing the changing form of the monument

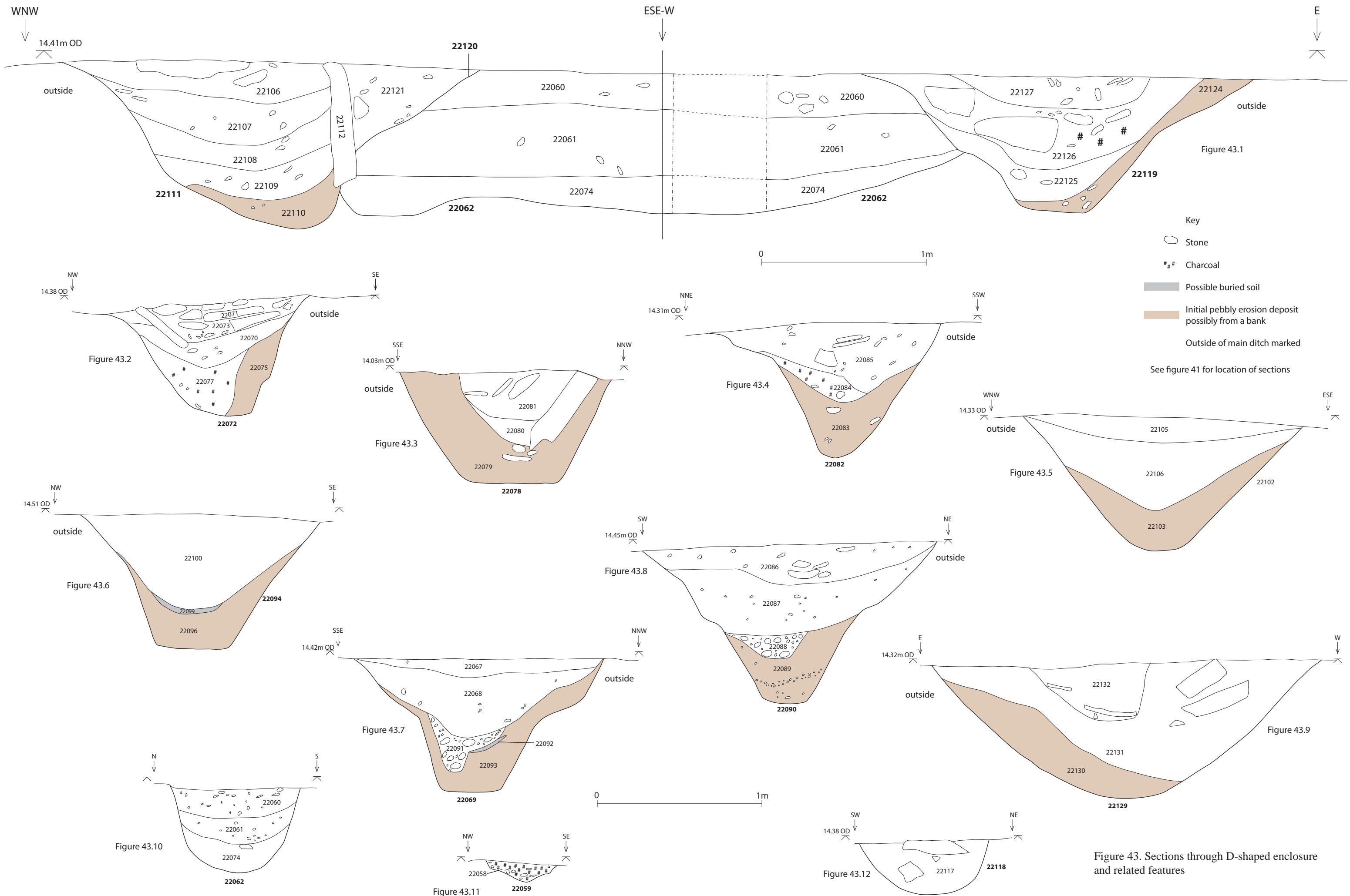
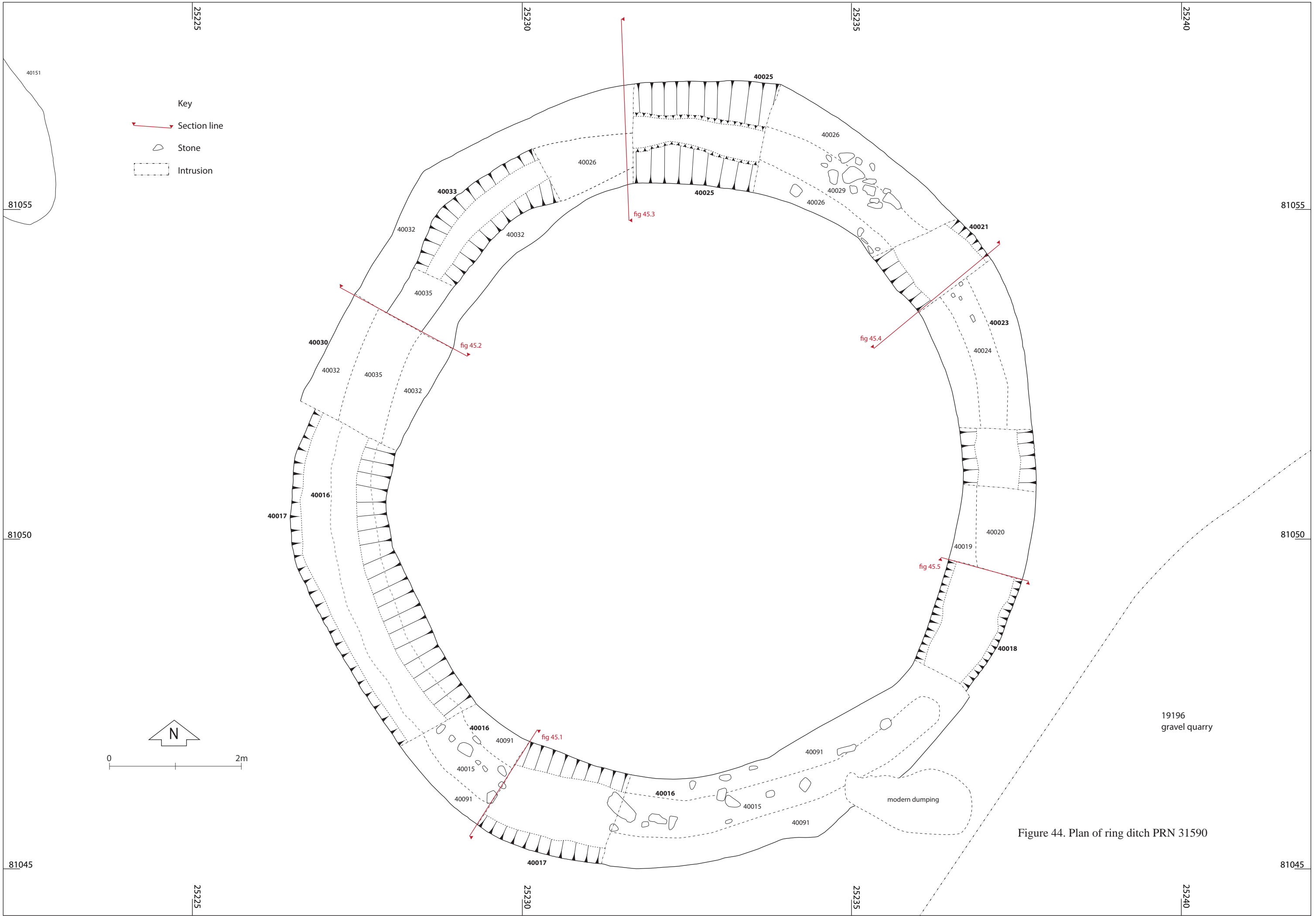

Figure 43. Sections through D-shaped enclosure and related features



- Key
- Section line
 - ◻ Stone
 - ◻ Intrusion

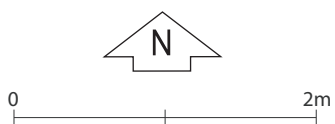
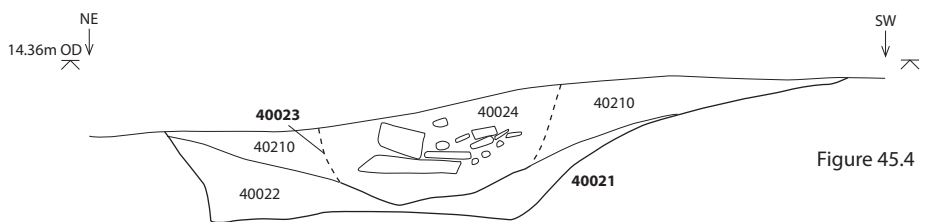
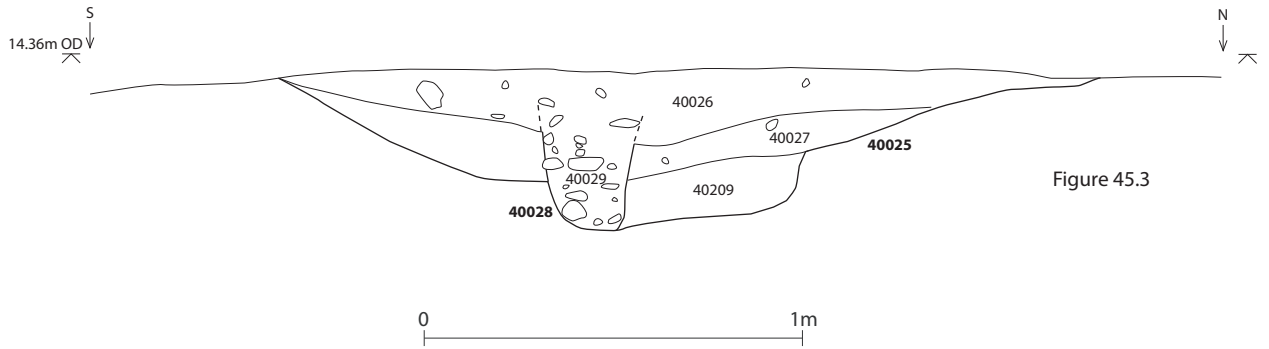
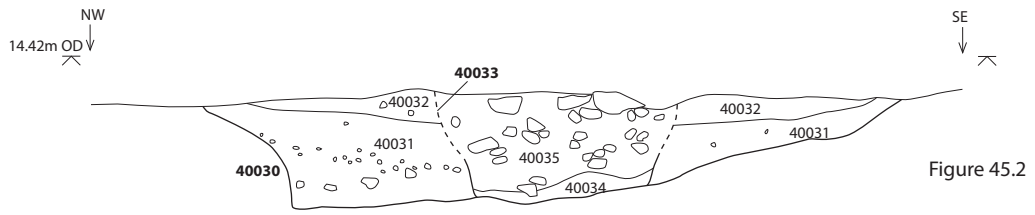
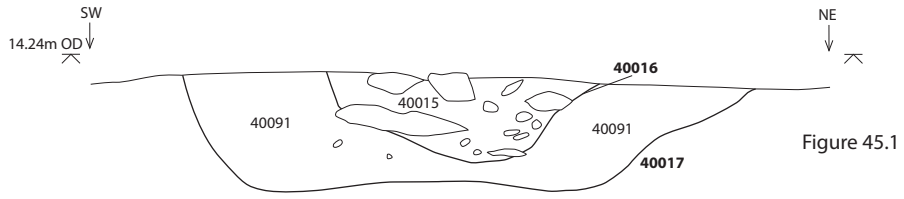

Figure 44. Plan of ring ditch PRN 31590



See figure 44 for location of sections

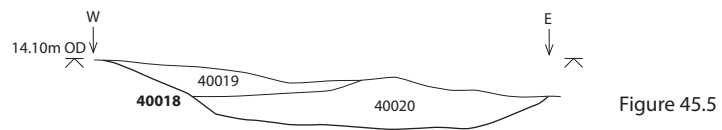

Figure 45. Sections across ring ditch

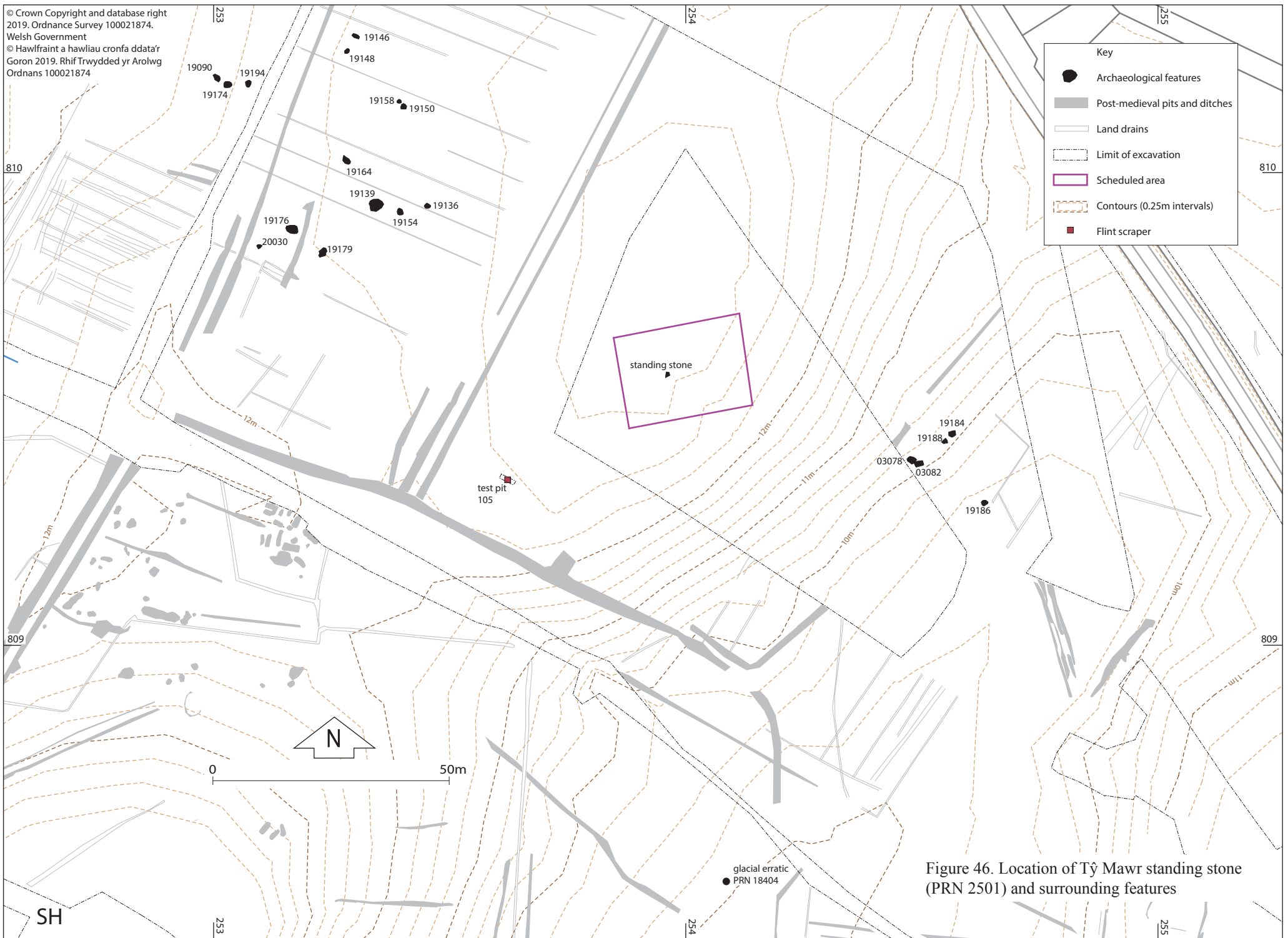
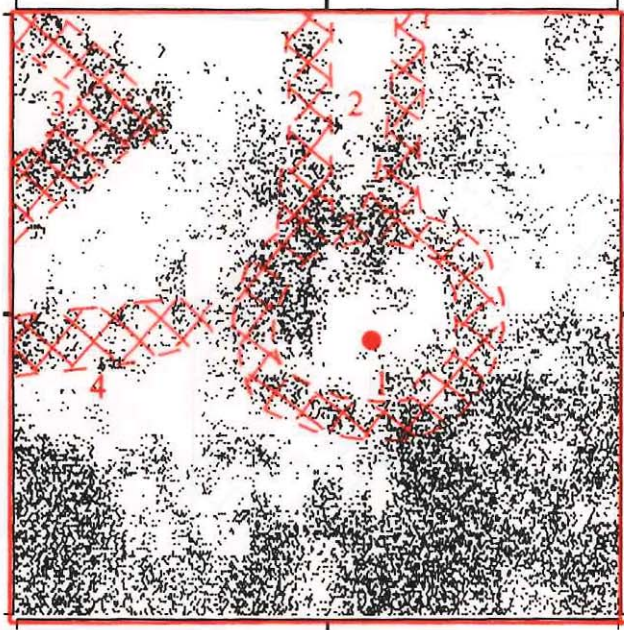

Figure 46. Location of Tŷ Mawr standing stone (PRN 2501) and surrounding features

TY MAWR

Resistance Data



Range: 95 to 120 ohms

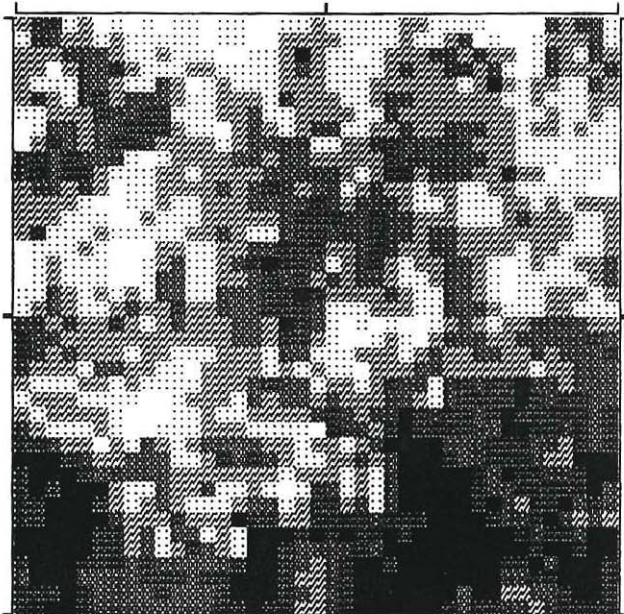

Range: 87 to 117 ohms



1:500

Figure 47. Resistance survey around the Tŷ Mawr Standing Stone by Geophysical Surveys of Bradford (from Ovenden 1990b)

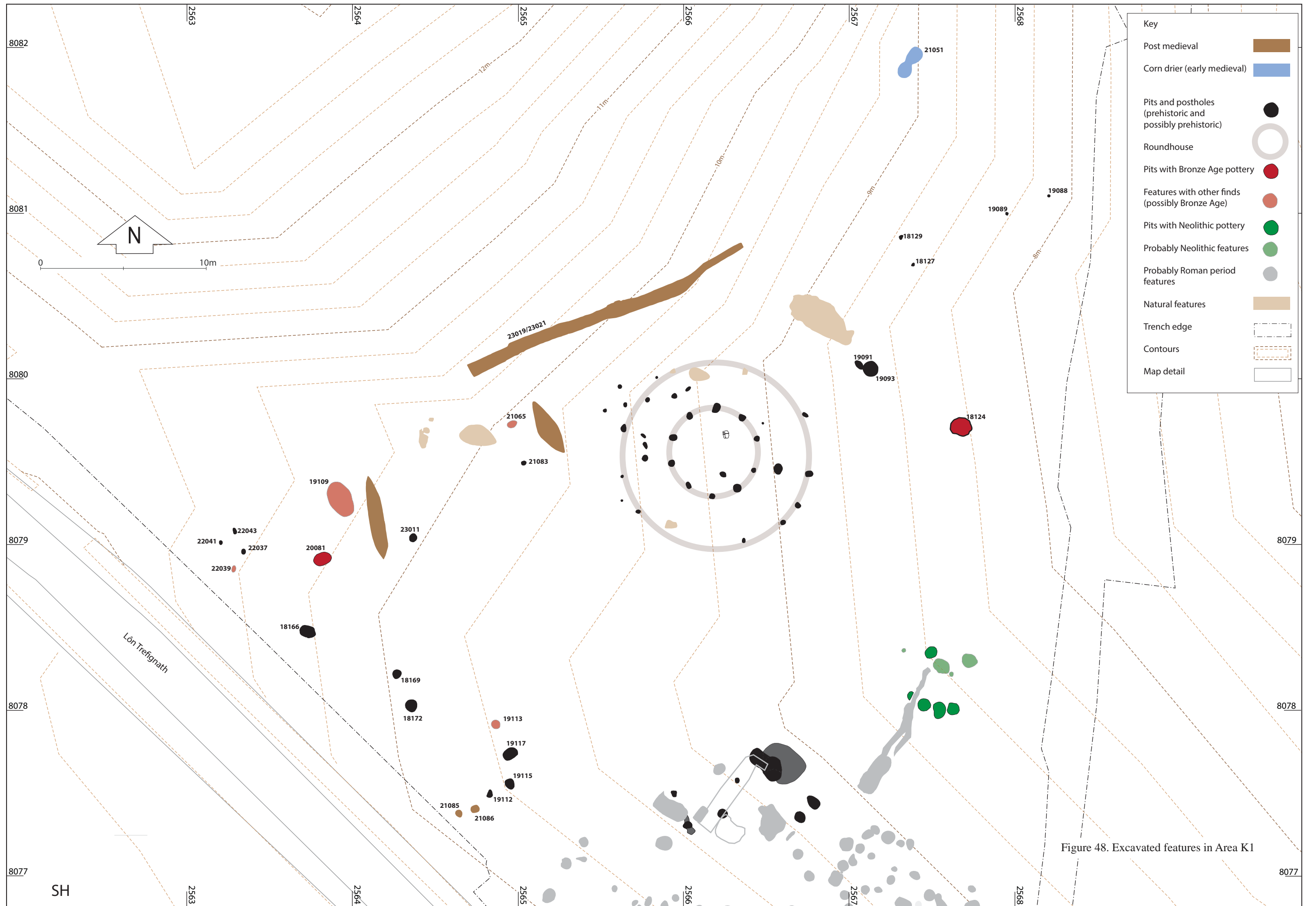

Figure 48. Excavated features in Area K1

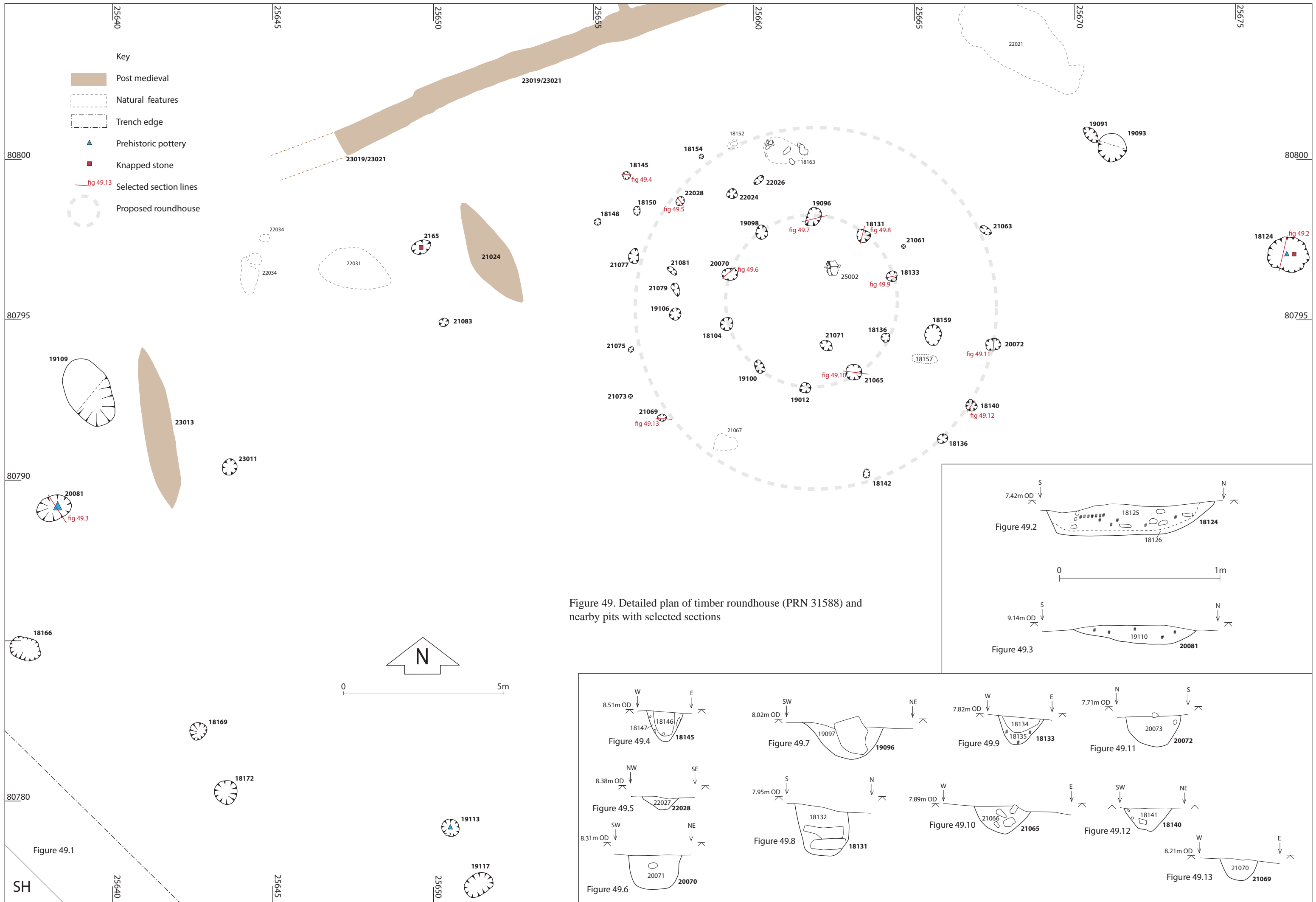
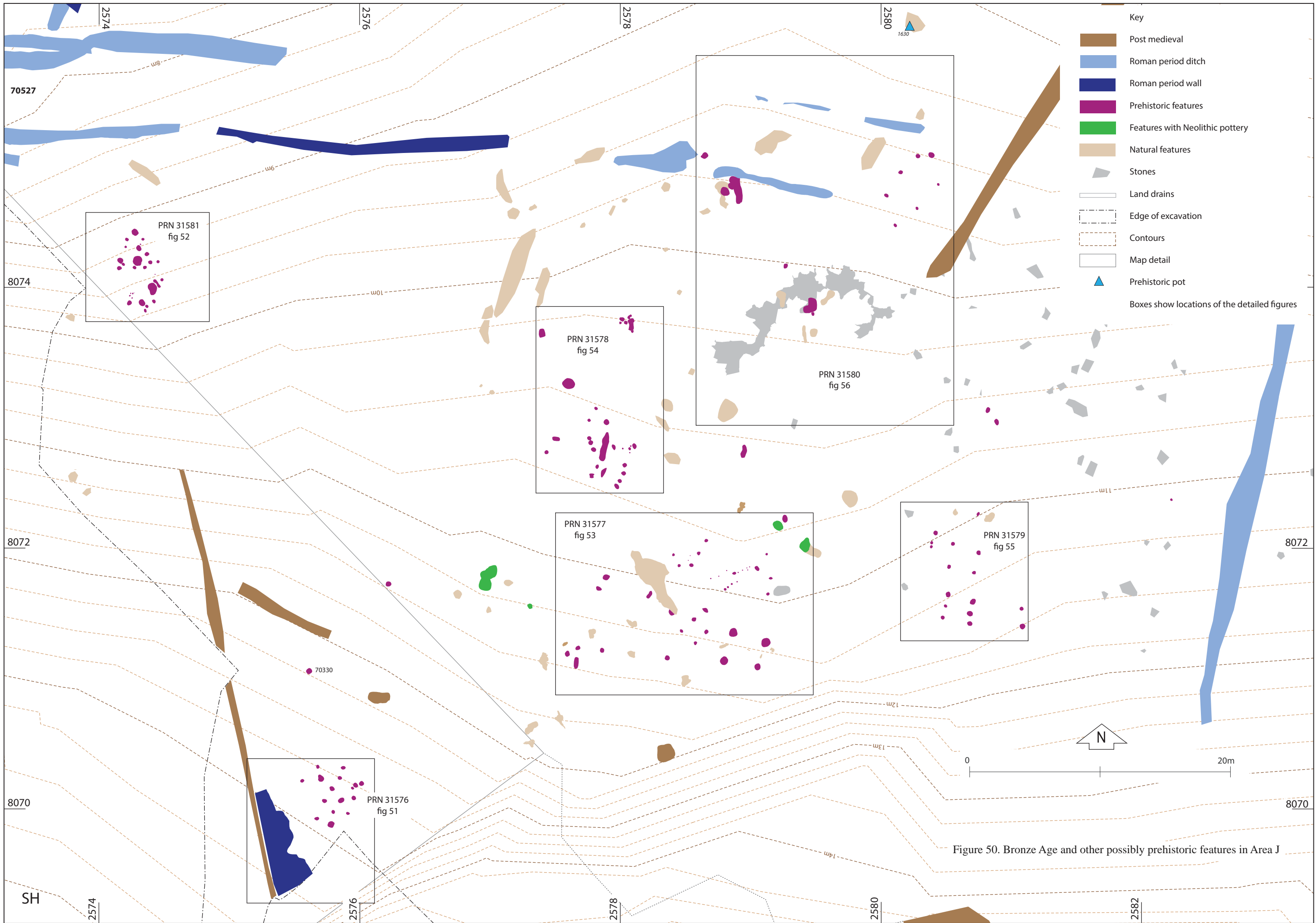

Figure 49. Detailed plan of timber roundhouse (PRN 31588) and nearby pits with selected sections



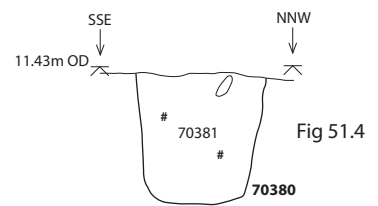
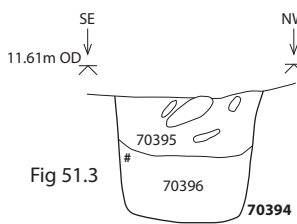
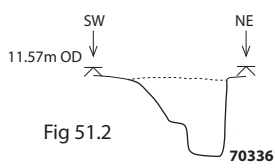
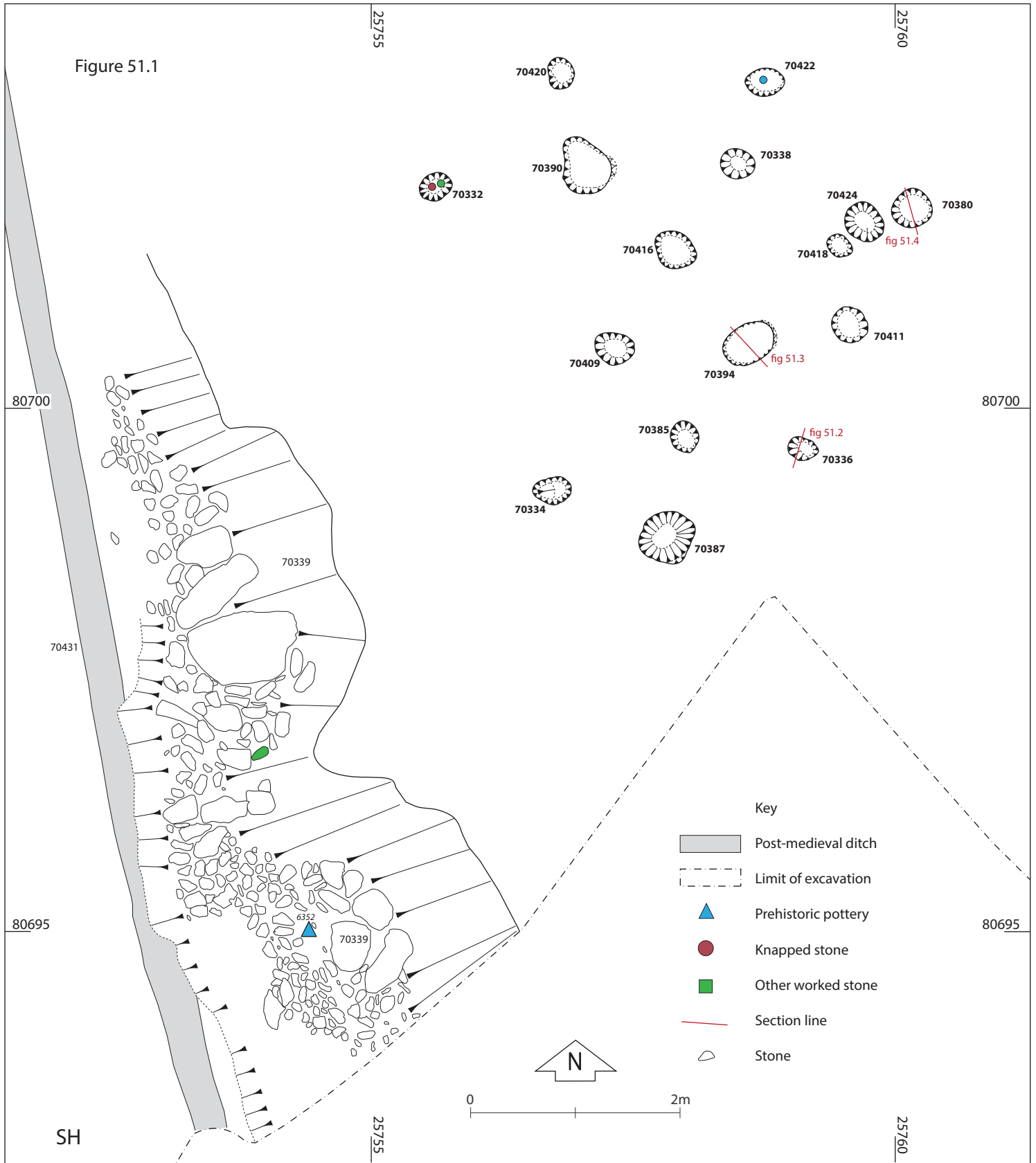

Figure 51. Plan of posthole group PRN 31576 with selected sections

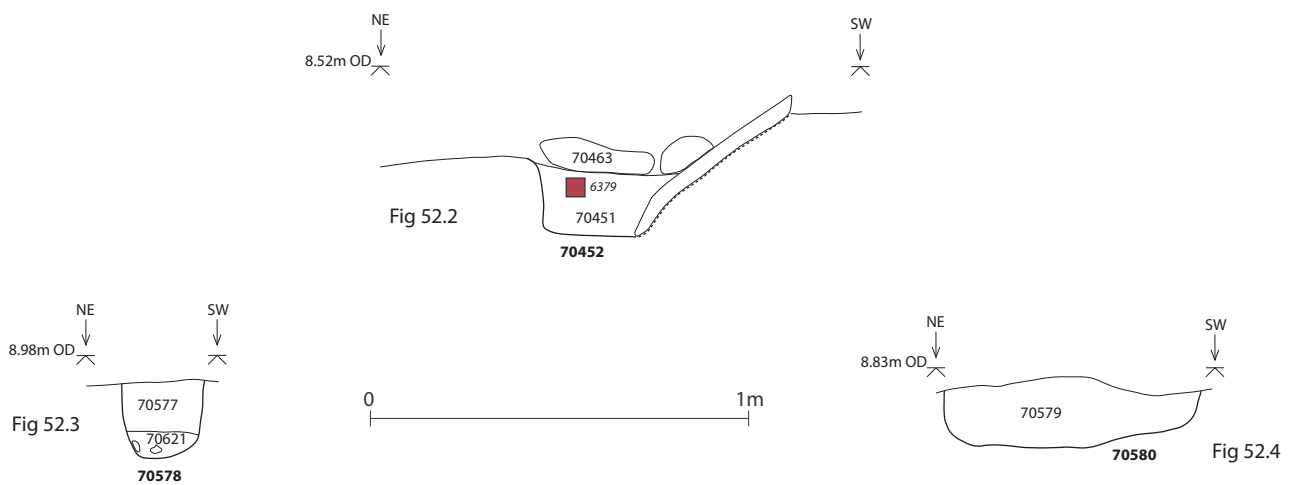
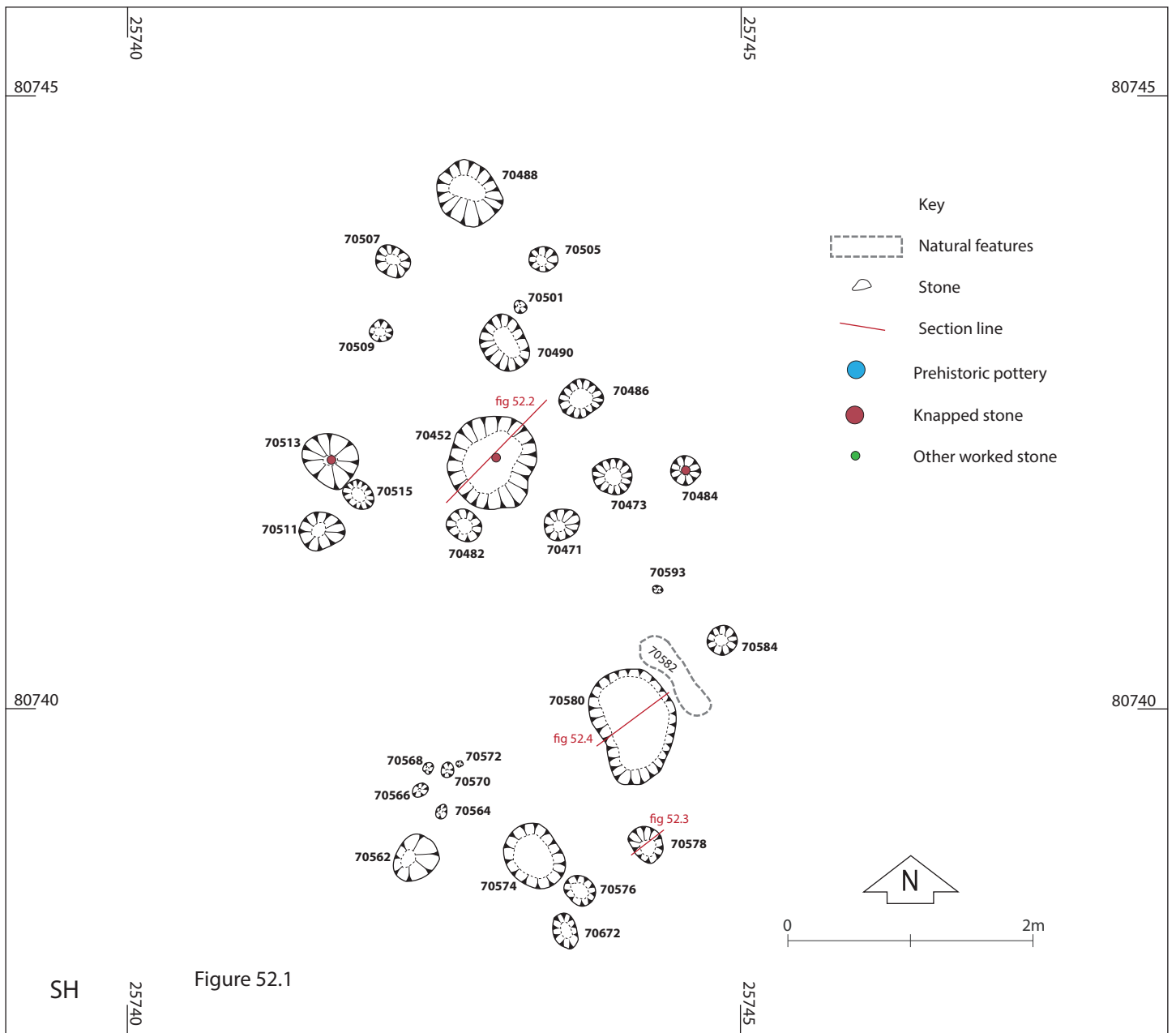

Figure 52. Plan of posthole group PRN 31581 with selected sections

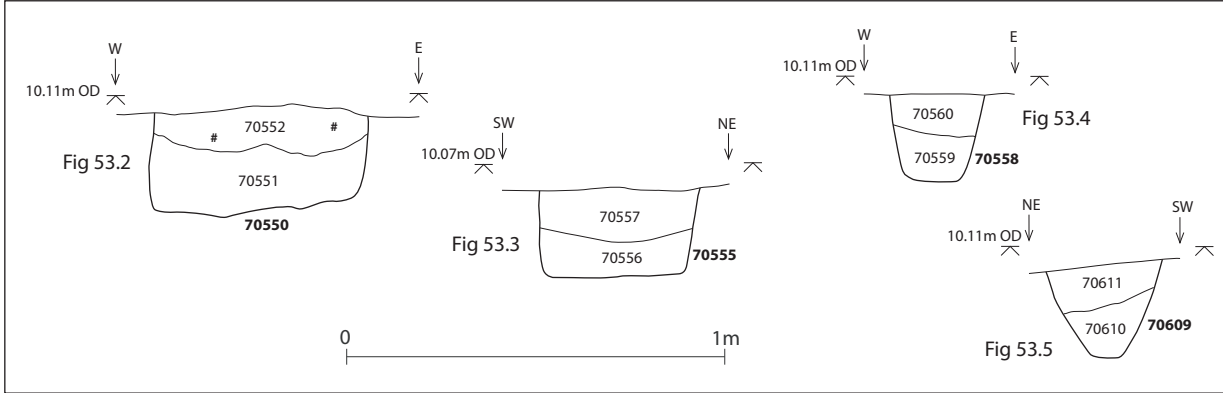
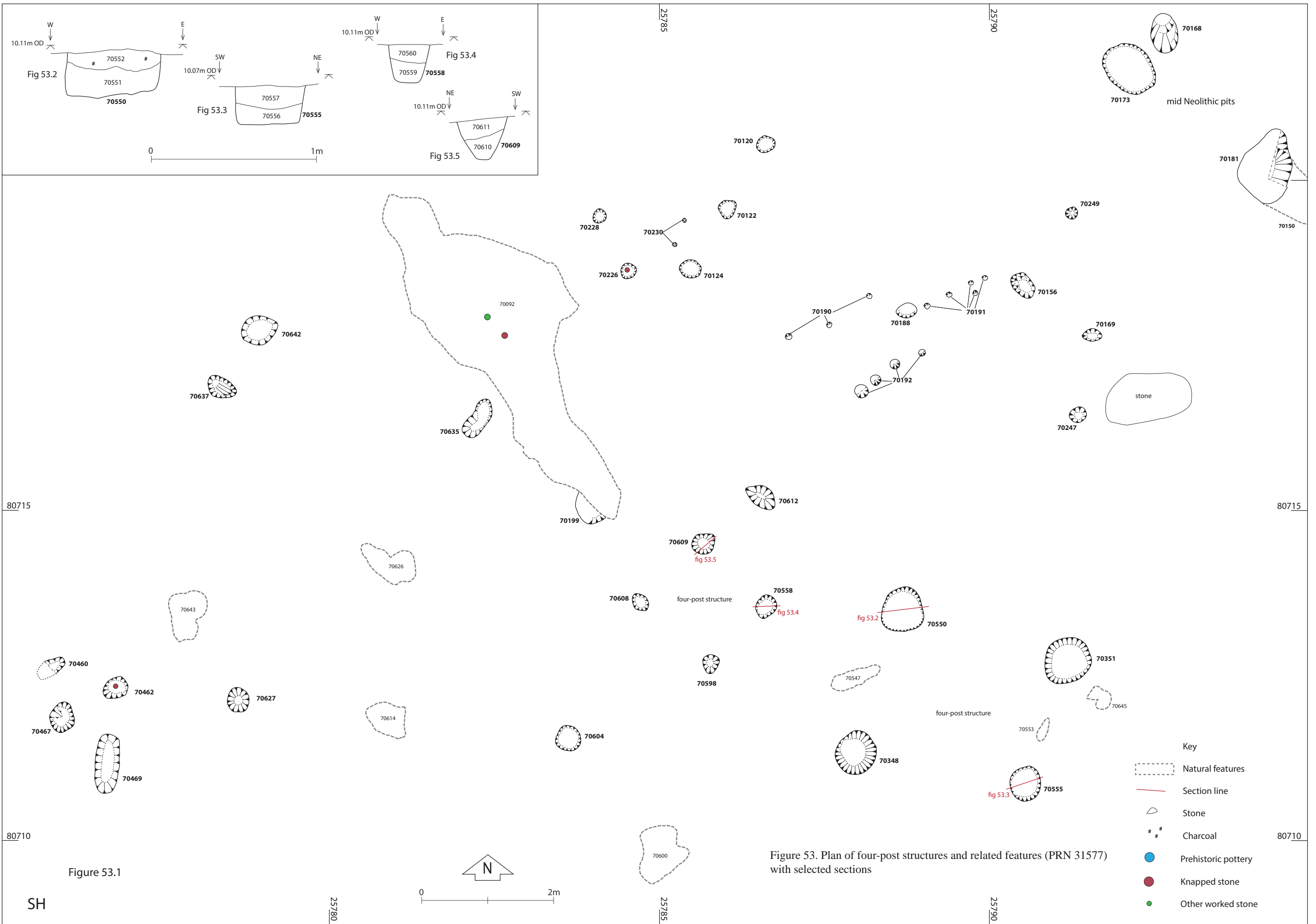

Figure 53. Plan of four-post structures and related features (PRN 31577) with selected sections

- Key
- Natural features
 - Section line
 - Stone
 - Charcoal
 - Prehistoric pottery
 - Knapped stone
 - Other worked stone

SH

Figure 53.1

80715

80710

80715

80710

25780

25785

25790







25785

25790



25775

Key

-  Natural features
-  Section line
-  Stone
-  Charcoal
-  Prehistoric pottery
-  Knapped stone
-  Other worked stone

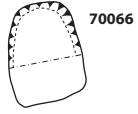

Figure 54. Plan of possible structures and related features (PRN 31578) with selected sections

80735

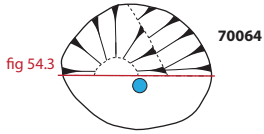

fig 54.3



70131

25780

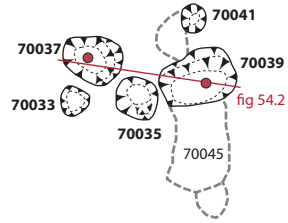
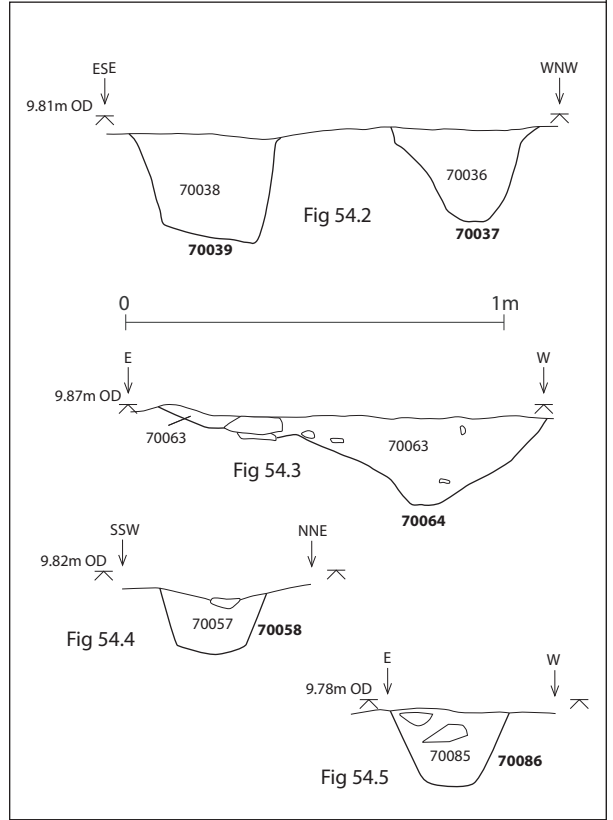

fig 54.2



80730

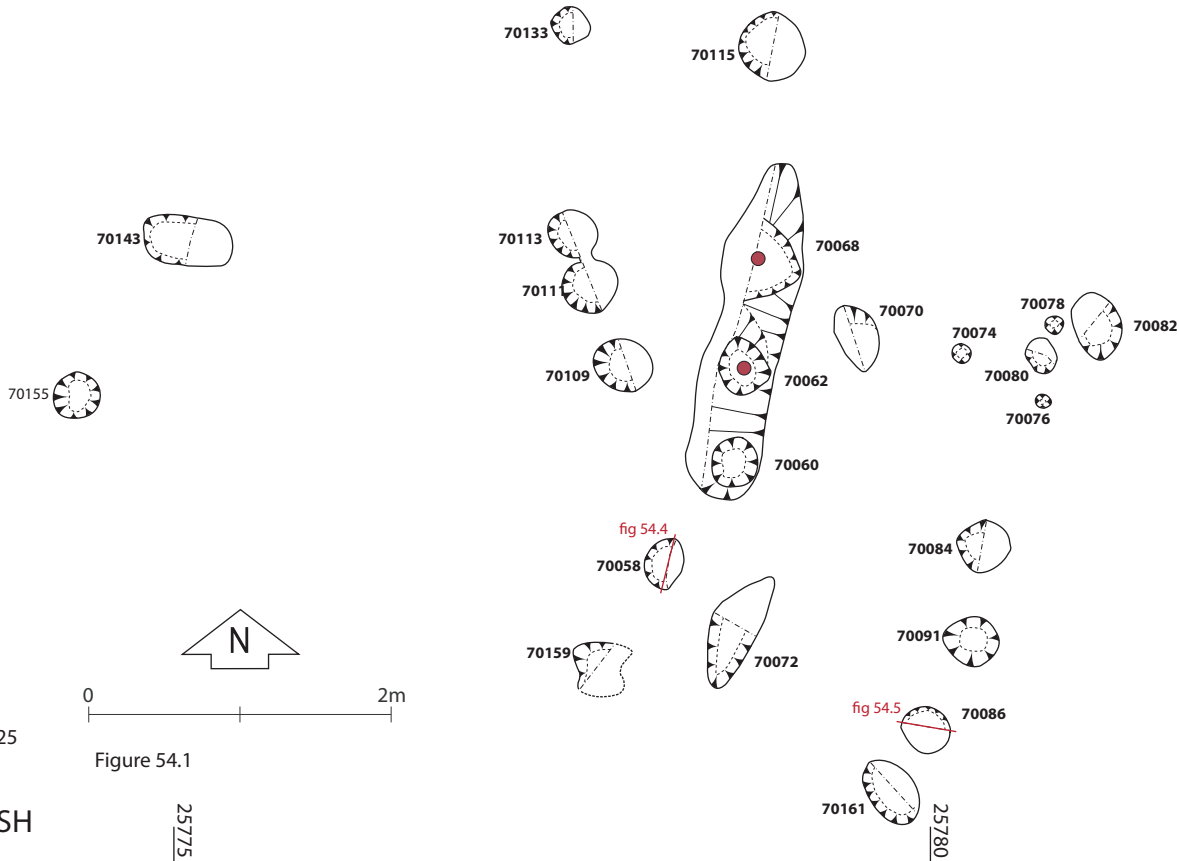

Figure 54.1

80725

SH

25775

80725

25780

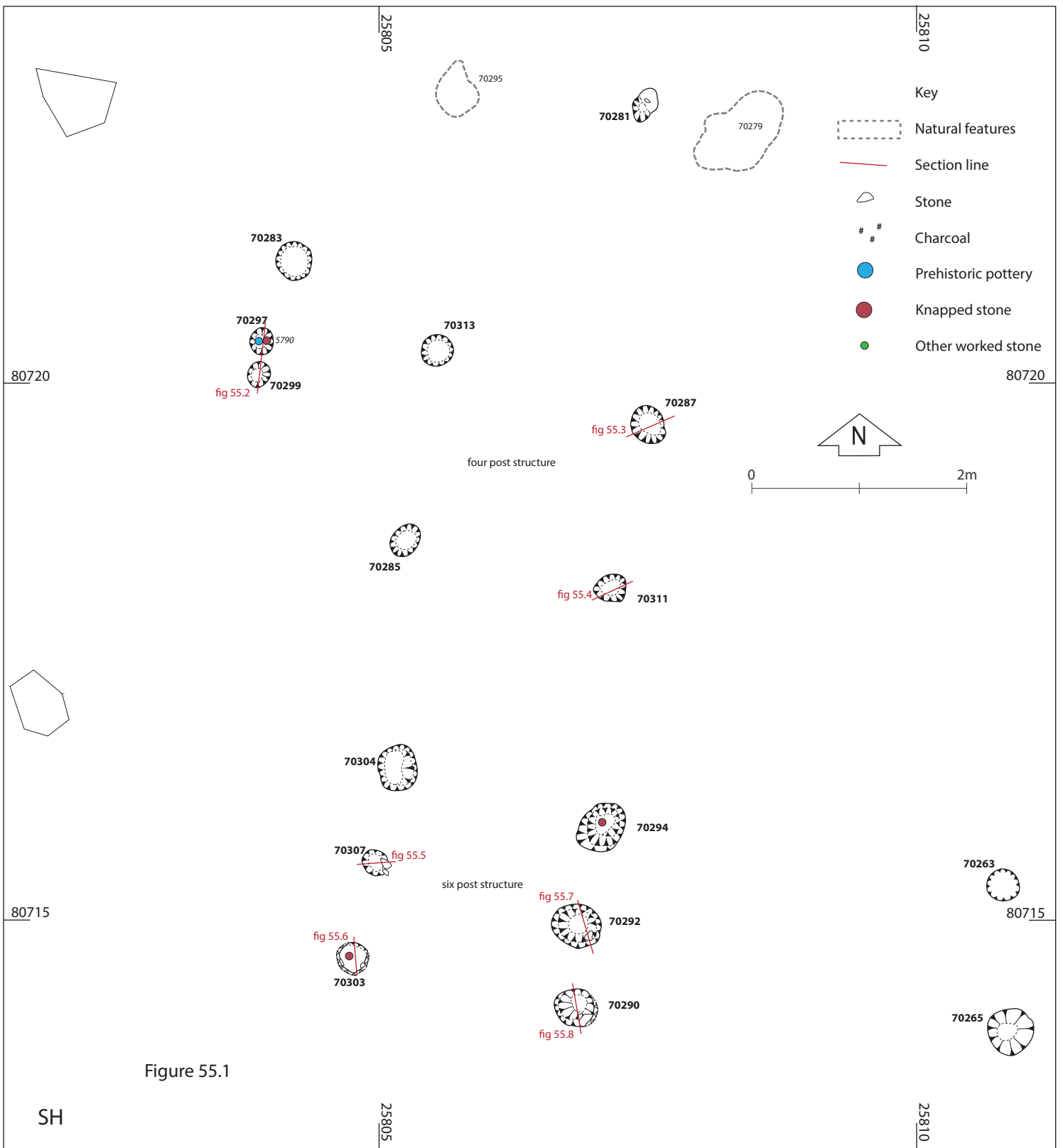

Figure 55.1

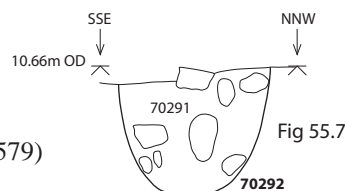
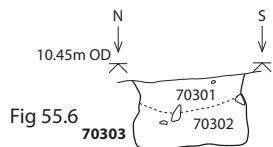
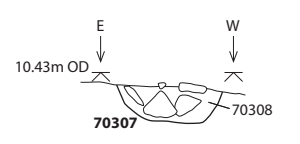
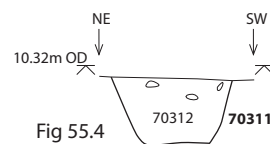
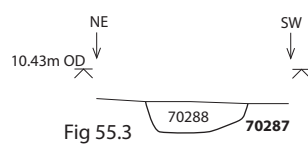
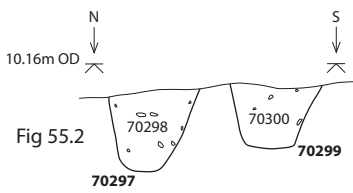

Figure 55. Plan of four-post and 6-post structures and related features (PRN 31579) with selected sections

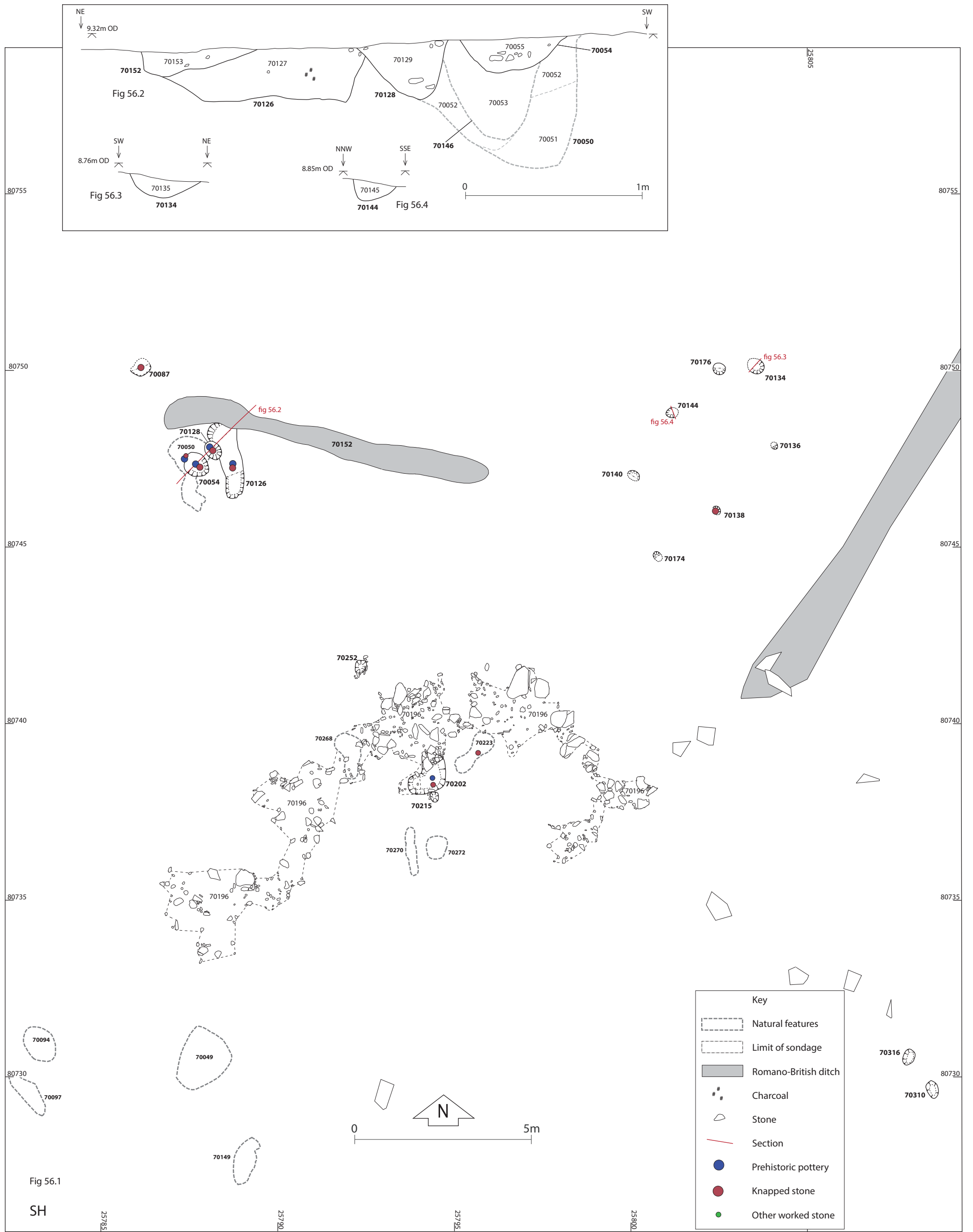
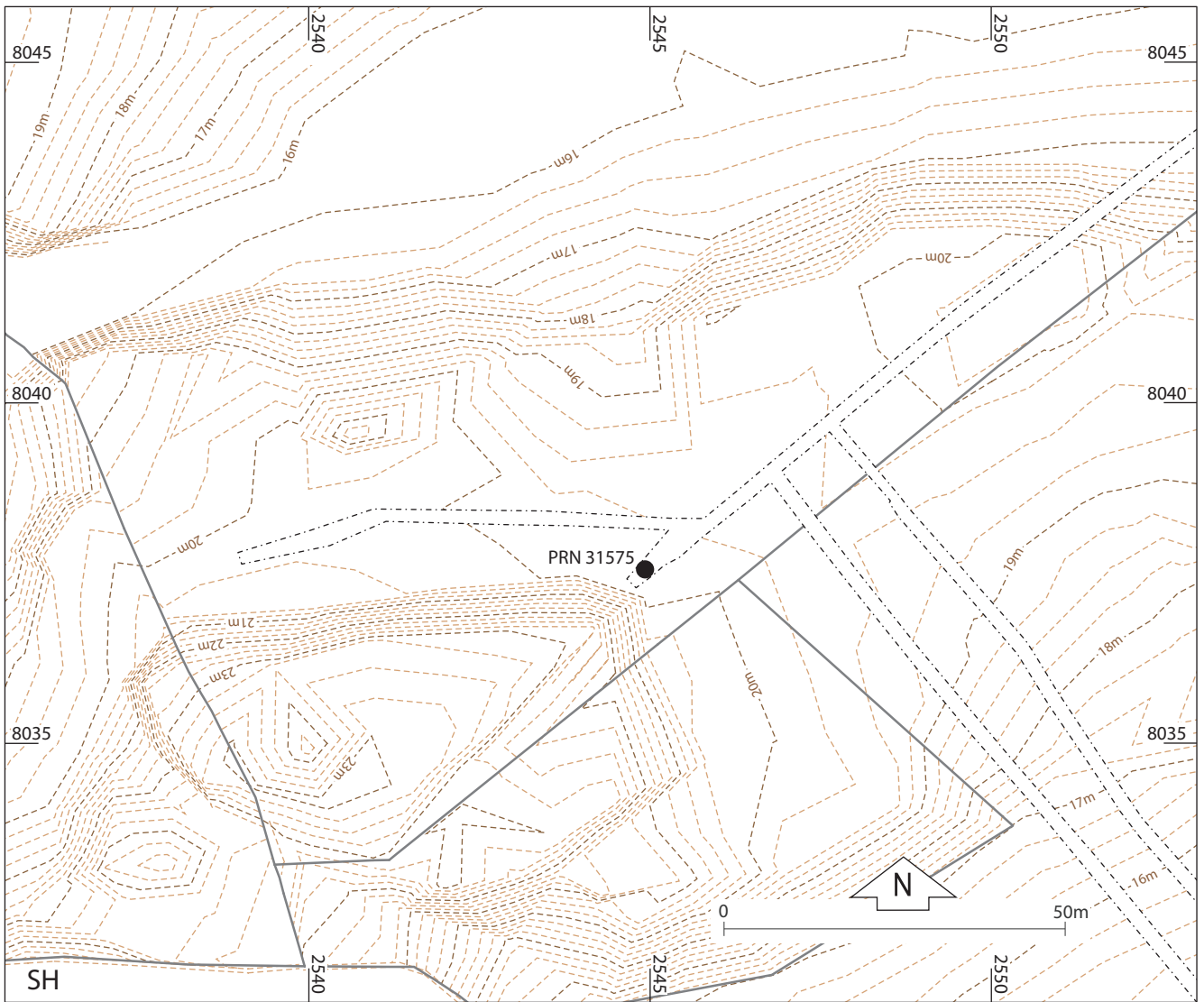

Figure 56. Plan of northern features in Area J (PRN 31580) with selected sections



- Key
- Stones
 - Land drains
 - Edge of excavation
 - Contours
 - Map detail

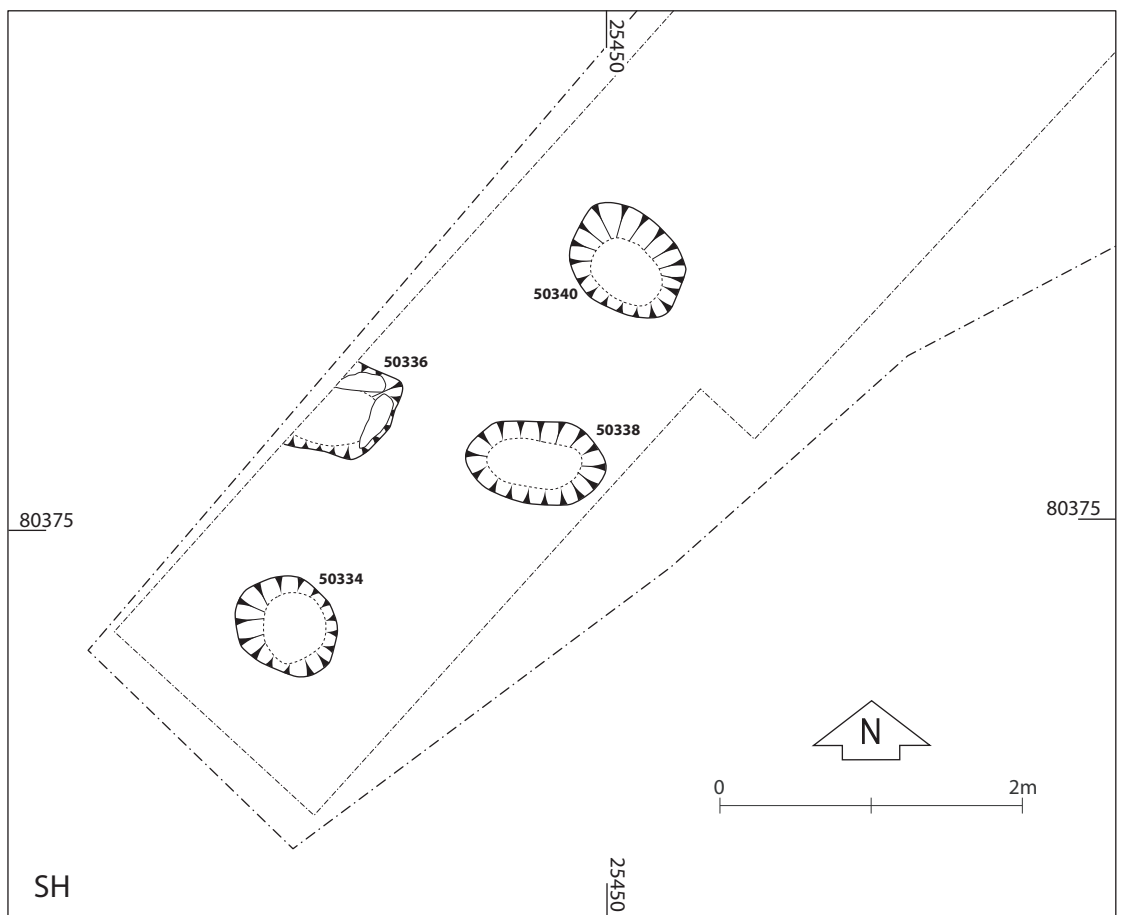

Figure 57. Location of pits PRN 31575 and detailed excavation plan





Figure 59. Investigation of the marsh edge deposits in Area F1

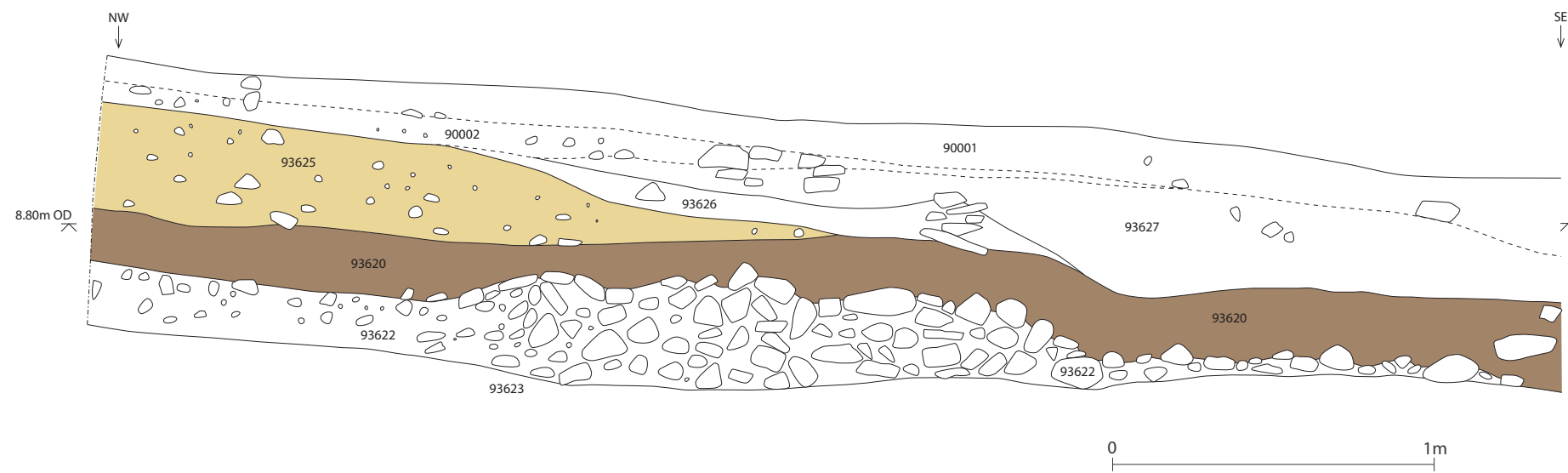

Figure 60.1

- Key
- Peaty layer
 - Dumped platform deposit
 - Grey silt
 - Stone
 - Bark and branches

See figure 59 for location of sections

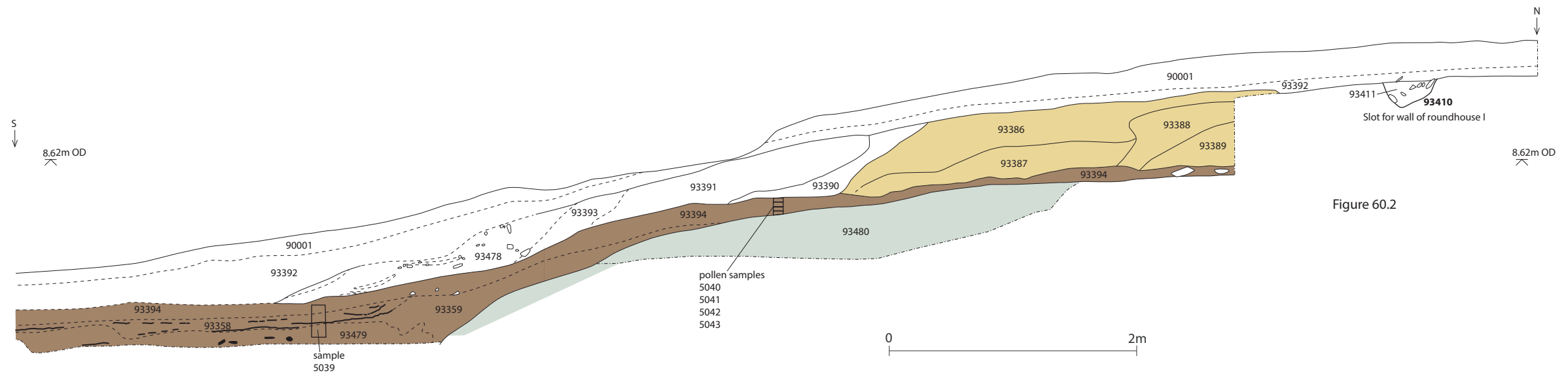
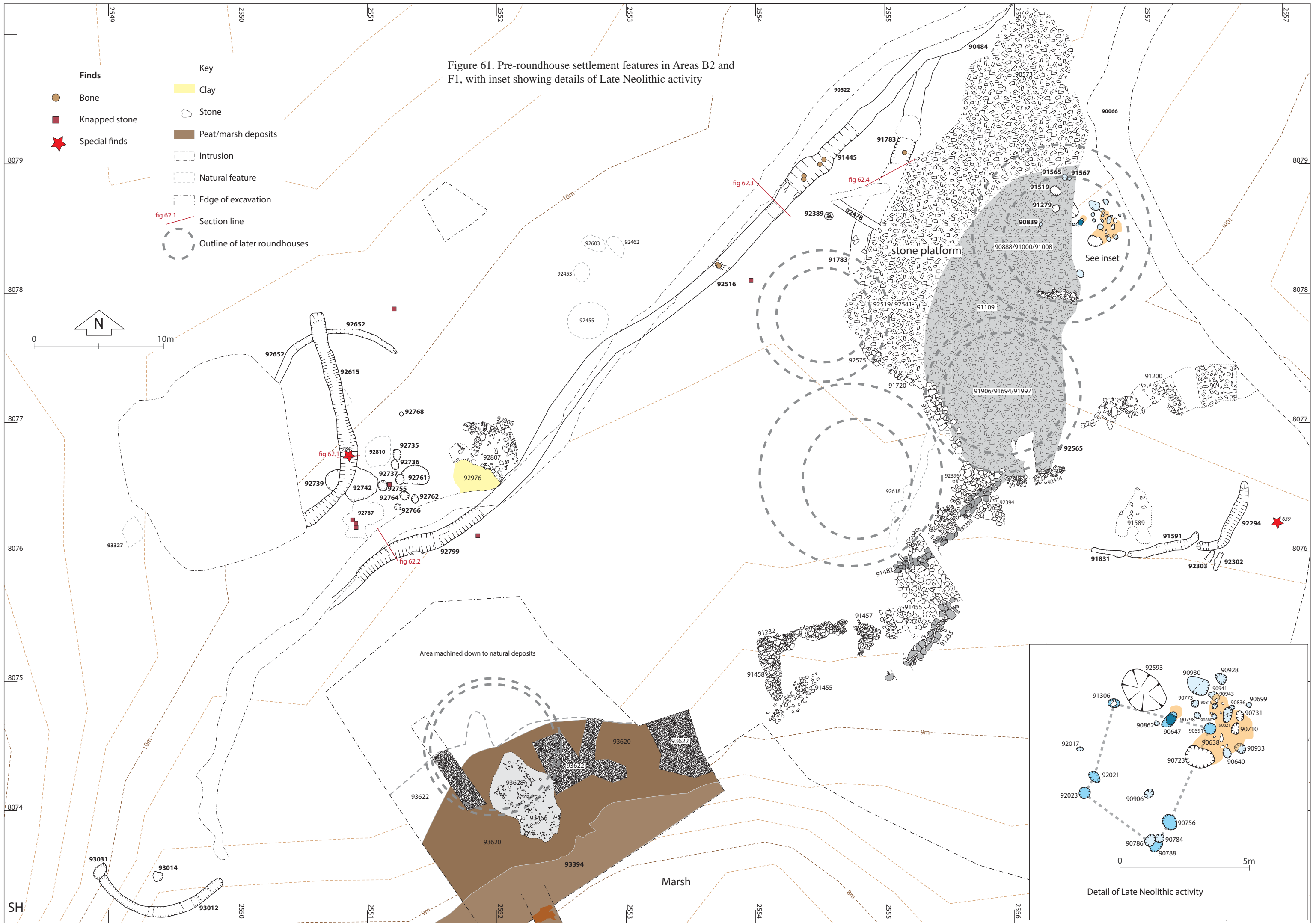

Figure 60.2

Figure 60. Sections of the deposits on the edge of the marsh

Figure 61. Pre-roundhouse settlement features in Areas B2 and F1, with inset showing details of Late Neolithic activity



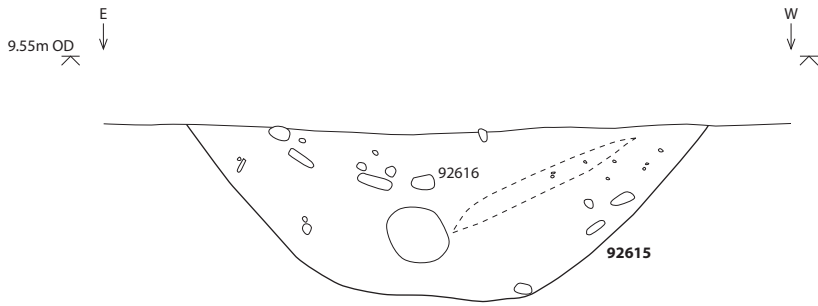

Fig 62.1. North facing section of ditch 92615

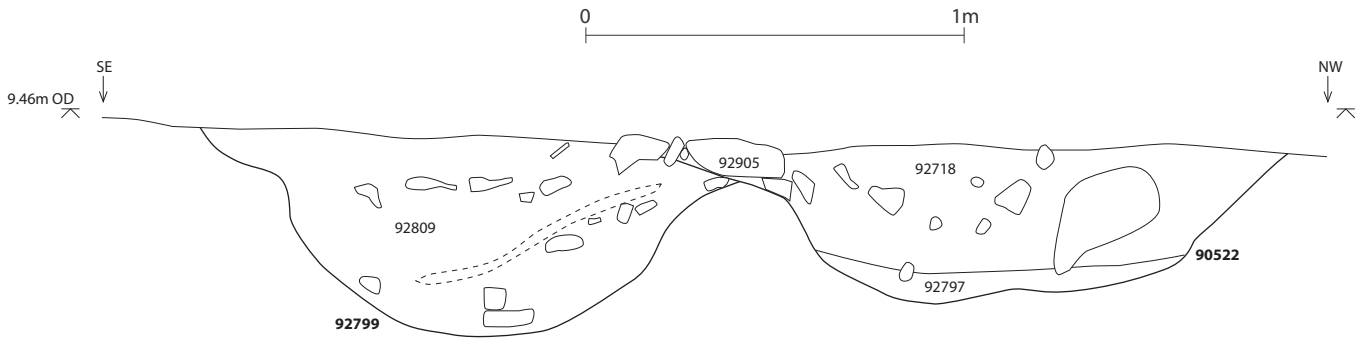

Fig 62.2. North-east facing section through ditch 92799 and culvert 90522

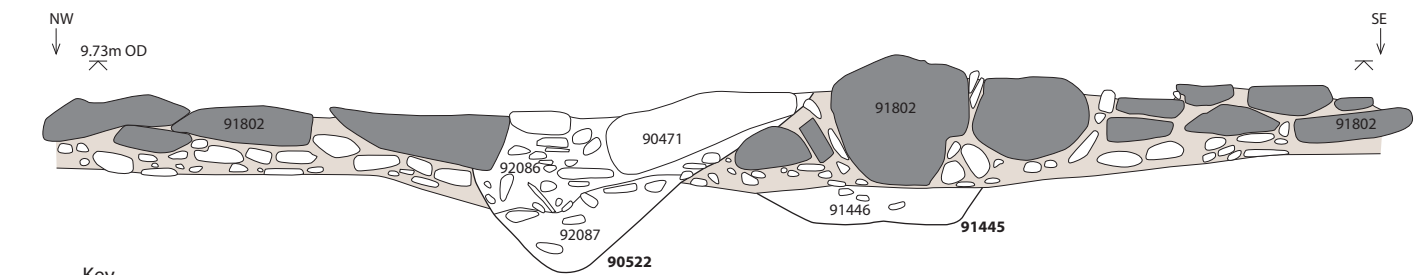





Fig 62.3. South-west facing section showing ditch 91445 under wall 91802 (part of 90010) and culvert 90522 cutting through this wall

- Key
-  Stones
 -  Iron Age deposits
 -  Stones in walls

See figure 61 for location of sections
(and also figure 68 for location of Fig 62.4)

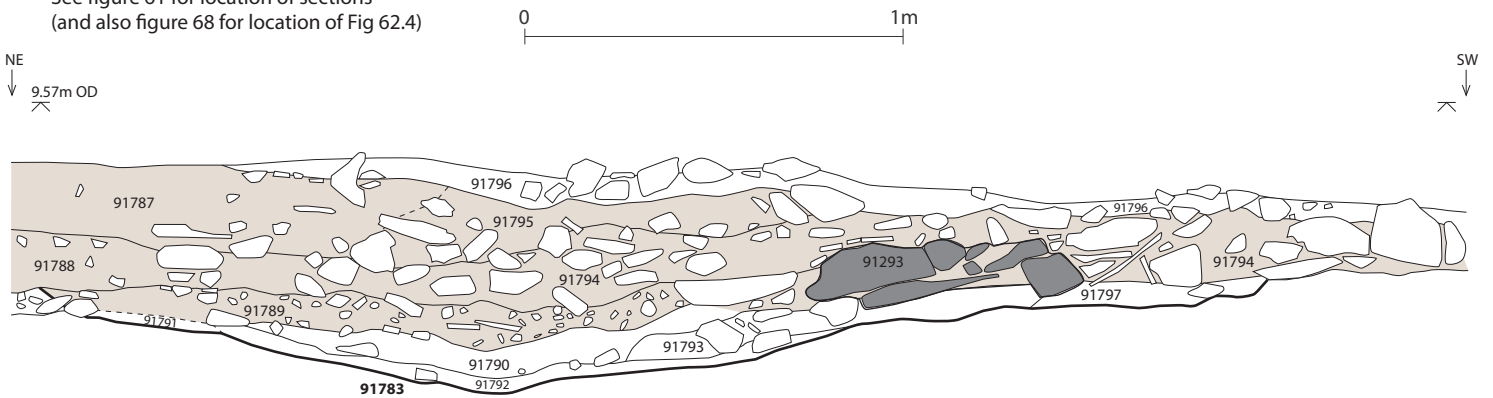

Fig 62.4. South-east facing section at an angle through ditch 91783 showing it sealed under later deposits

Figure 62. Selected sections through pre-roundhouse settlement ditches and related deposits

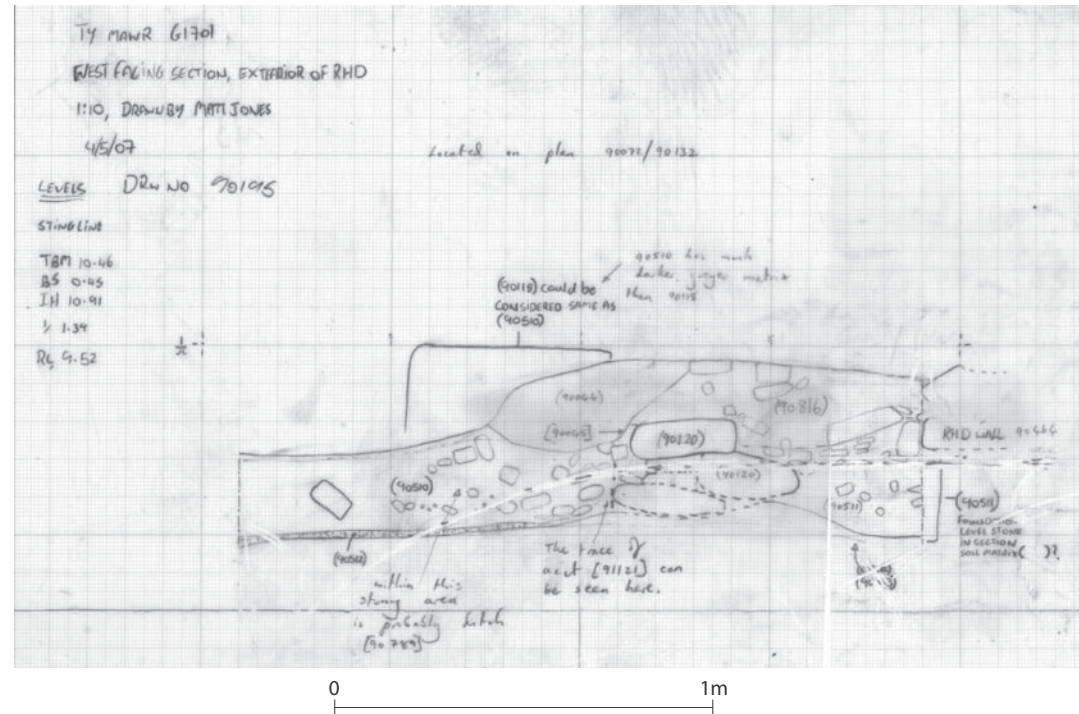

Figure 63.1 Field drawing of west facing section through walls 90120 and 90464 (drawing number 90195)



Figure 63.2 Photograph of section above

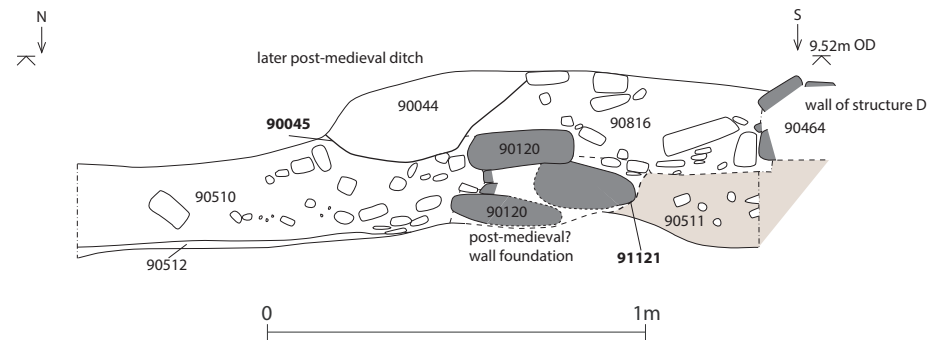

Figure 63.3 Reinterpretation of west facing section through walls 90120 and 90464

Figure 63. Reinterpretation of west facing section through walls 90120 and 90464

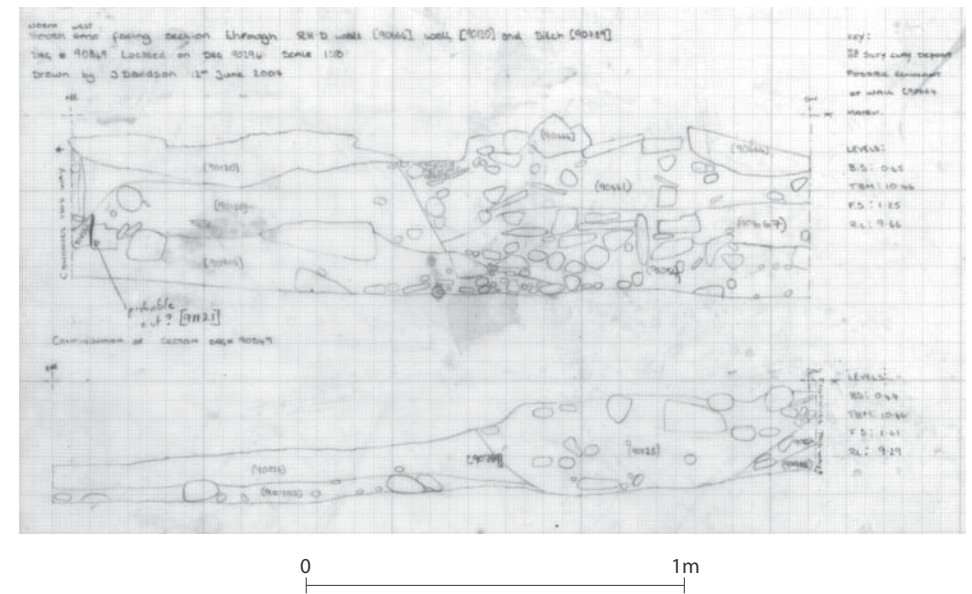

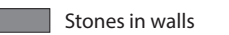

Figure 64.1 Field drawing of north-west facing section through walls 90120 and 90464 (drawing number 90349)



Figure 64.2 Photograph of section above

See figures 65 and 75 for location of sections

- Key
-  Stones
 -  Iron Age deposits
 -  Stones in walls

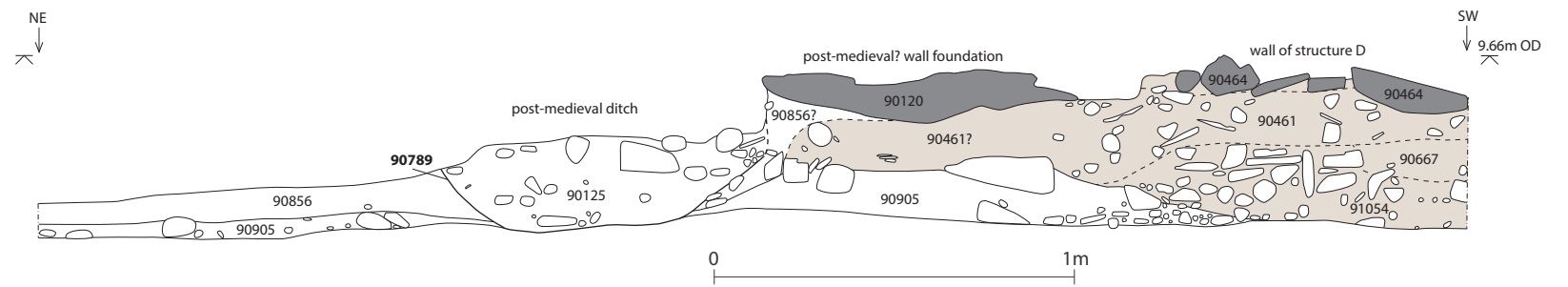

Figure 64.3 Reinterpretation of north-west facing section through walls 90120 and 90464

Figure 64. Reinterpretation of north-west facing section through walls 90120 and 90464

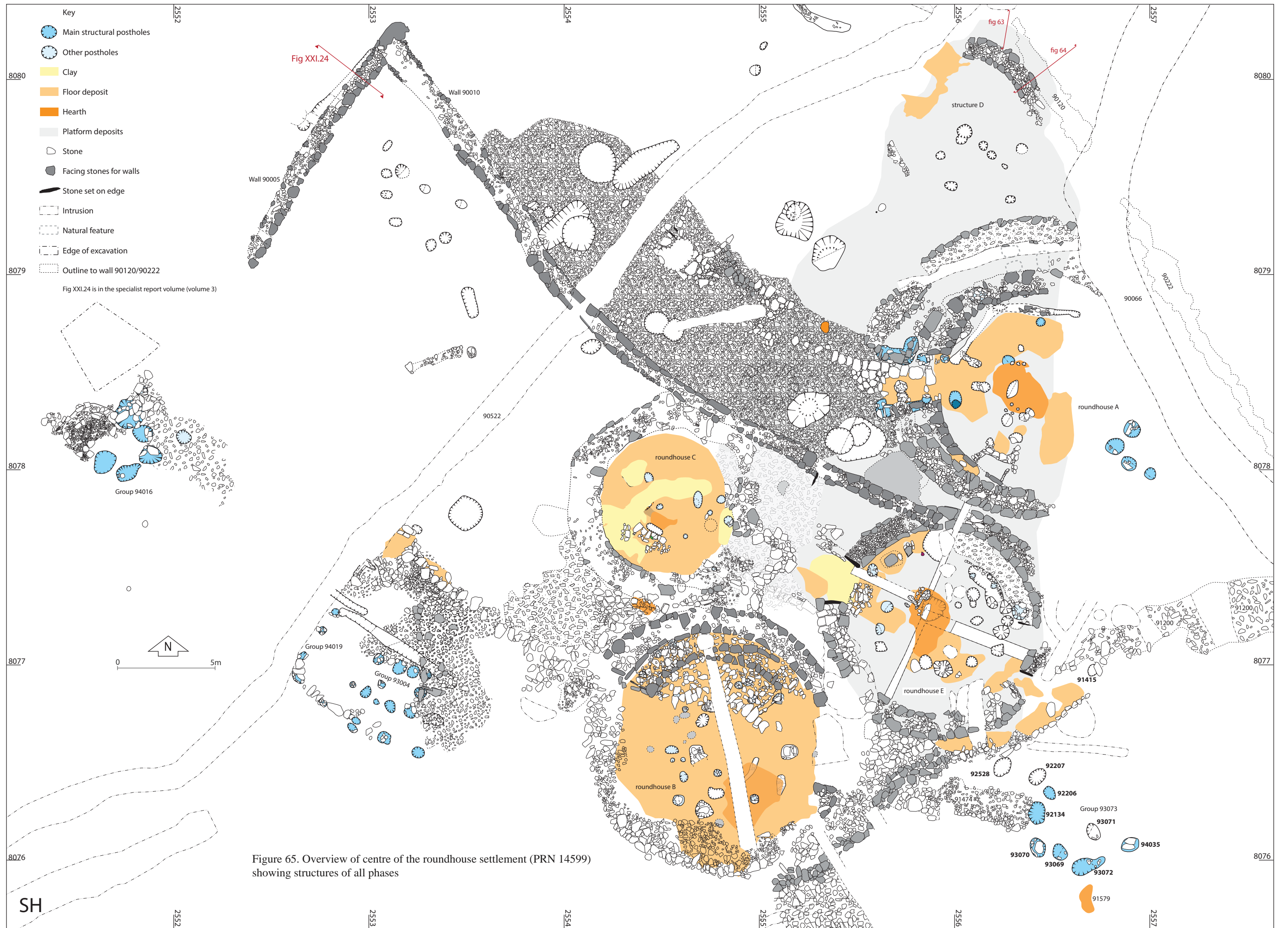
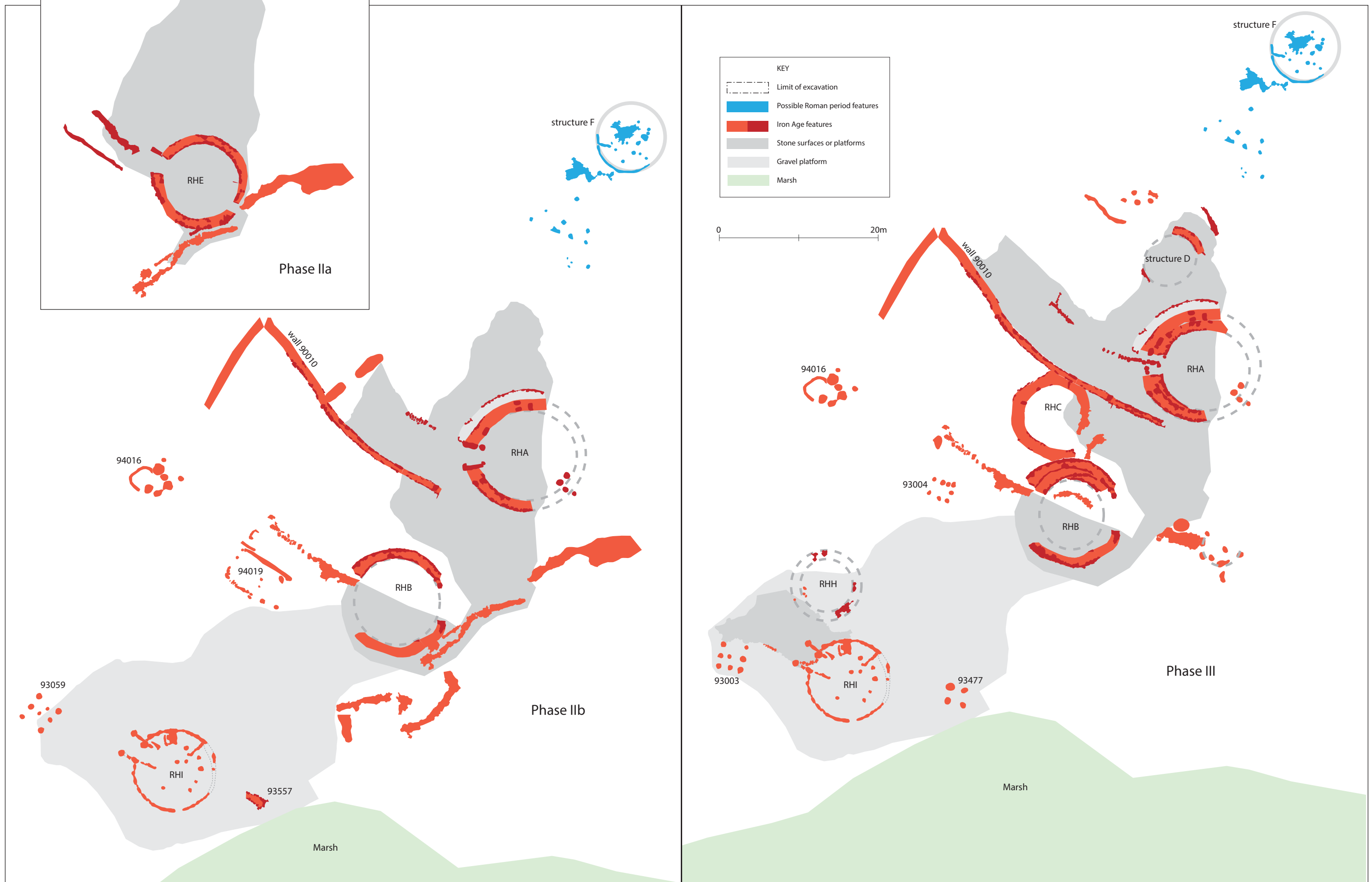

Figure 66. Phases of the roundhouse settlement



Summary matrix of areas B2 and F1

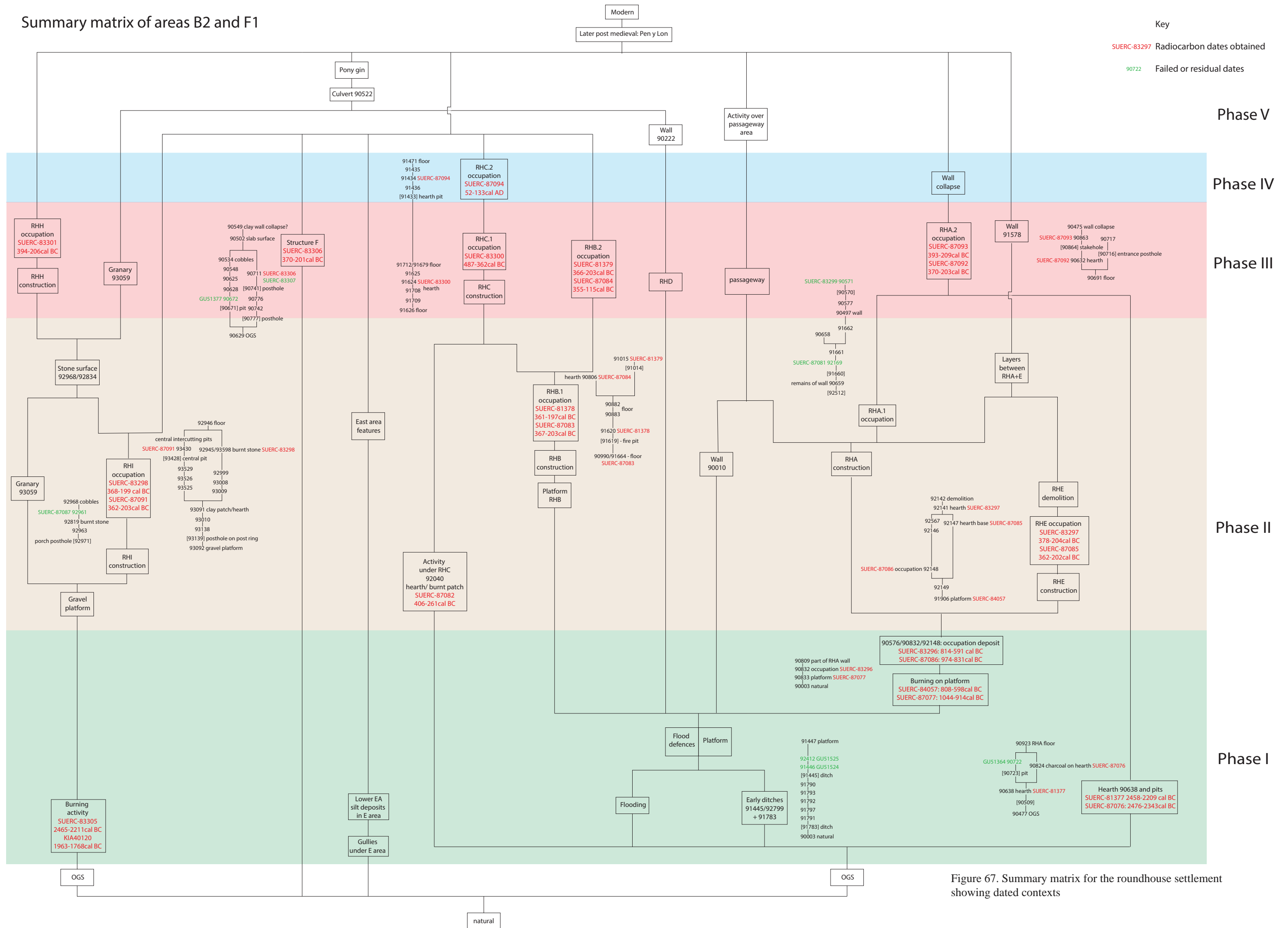

Figure 67. Summary matrix for the roundhouse settlement showing dated contexts

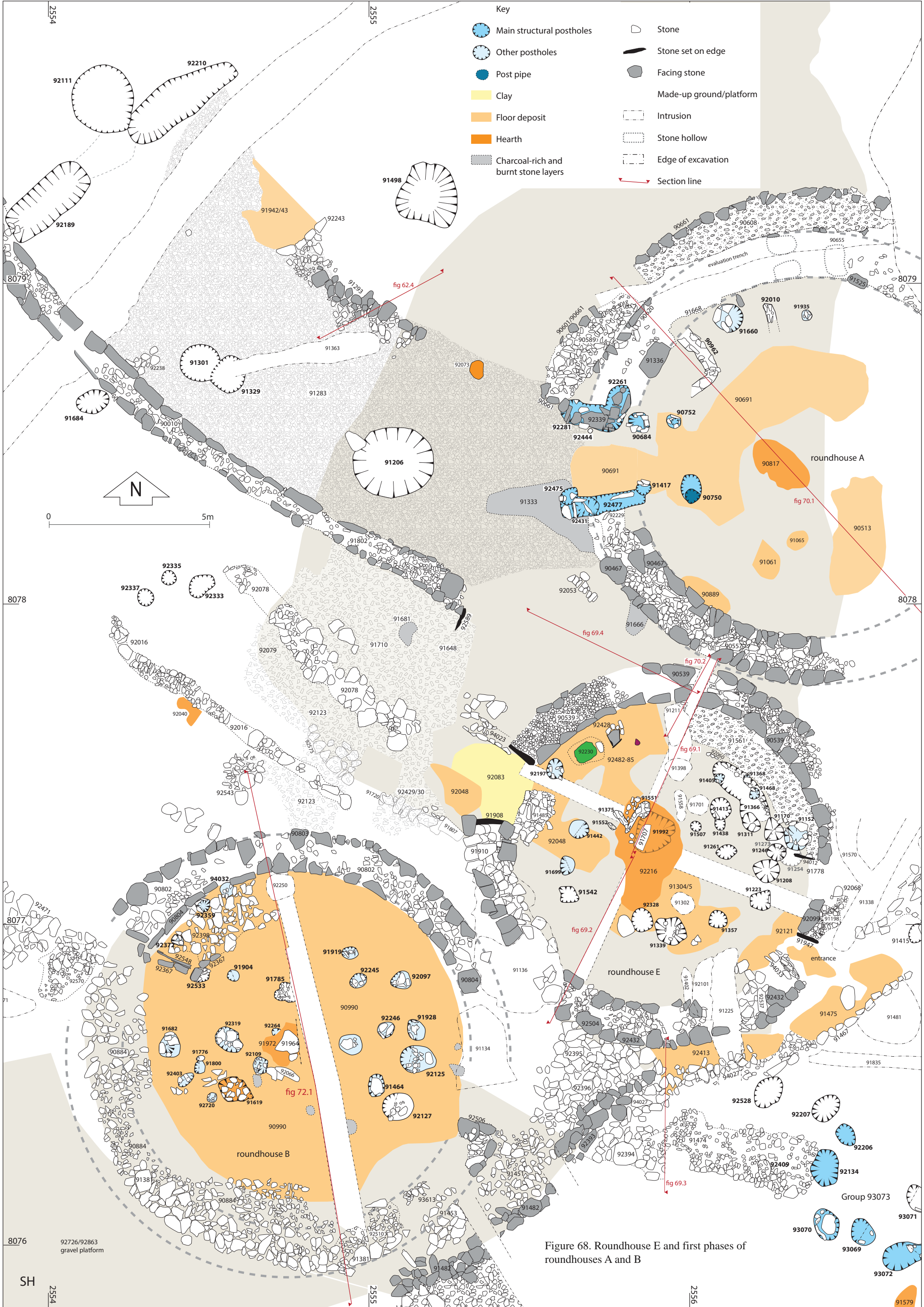

Figure 68. Roundhouse E and first phases of roundhouses A and B

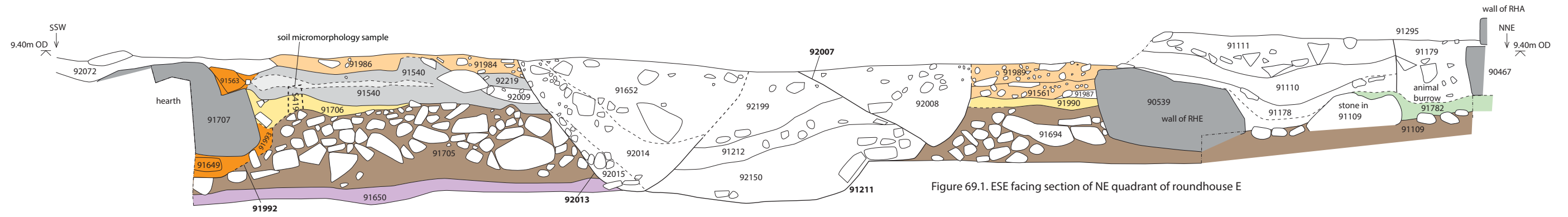

Figure 69.1. ESE facing section of NE quadrant of roundhouse E

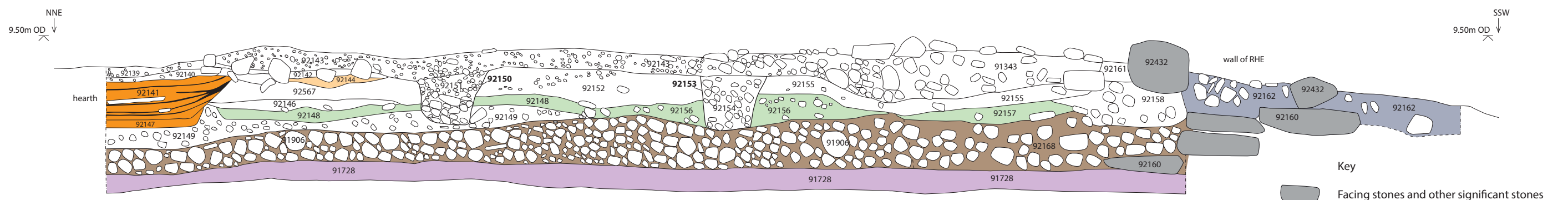

Figure 69.2. WNW facing section of SW quadrant of roundhouse E

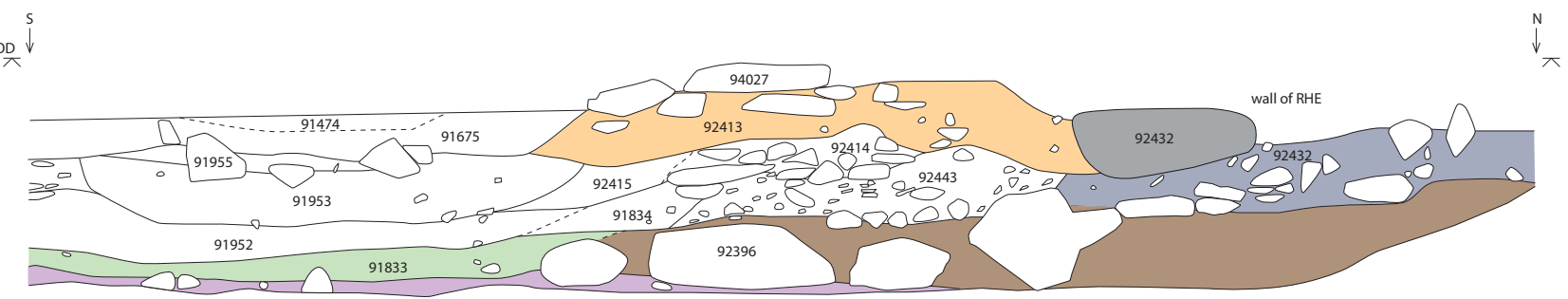

Figure 69.3. E facing section through deposits to south of roundhouse E

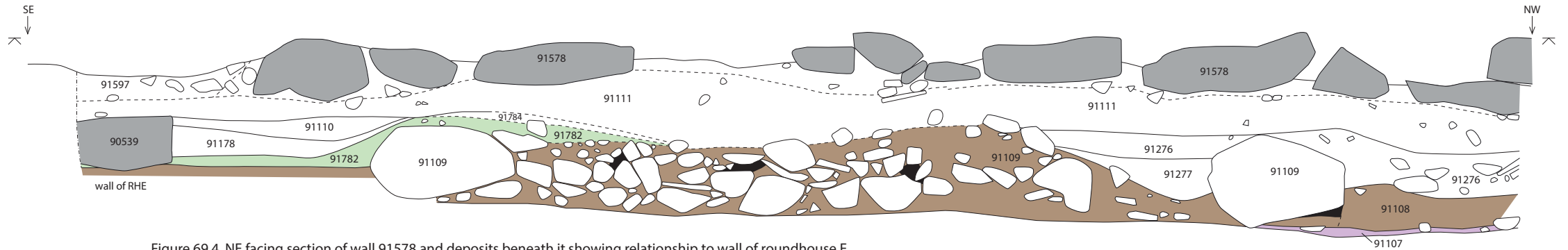

Figure 69.4. NE facing section of wall 91578 and deposits beneath it showing relationship to wall of roundhouse E

- Key
- Facing stones and other significant stones
 - Stones
 - Wall core
 - Upper floor layers
 - Lower floor layers
 - Hearths
 - Charcoal-rich layers
 - Soil/occupation layer over stone platform
 - Stone platform
 - Voids
 - Old ground surface

For location of sections see figures 68 and 75

Figure 69. Sections through roundhouse E

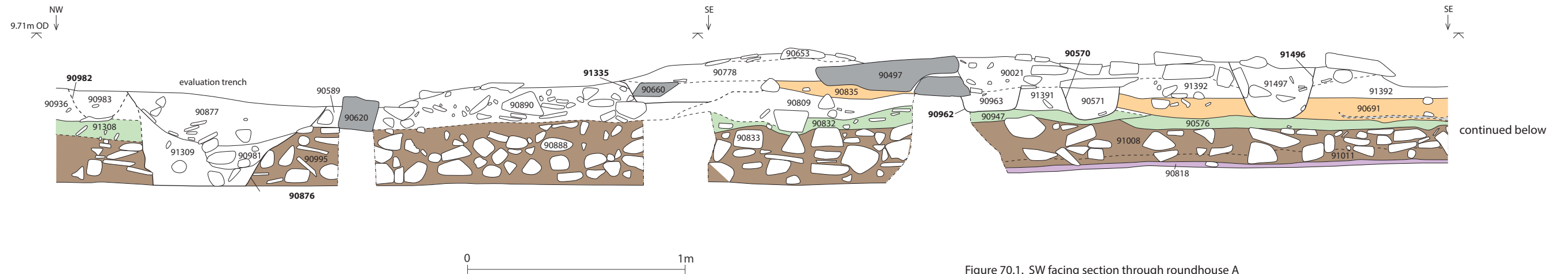

Figure 70.1. SW facing section through roundhouse A

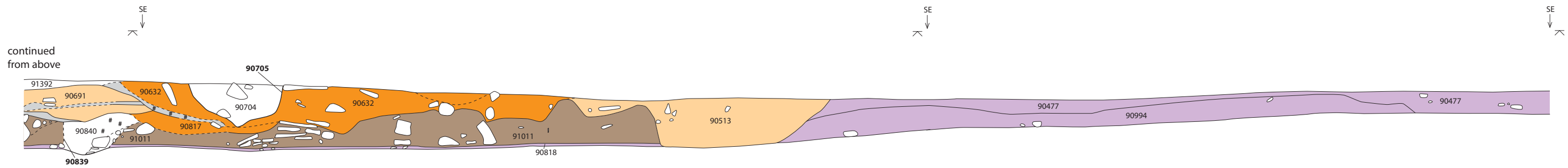
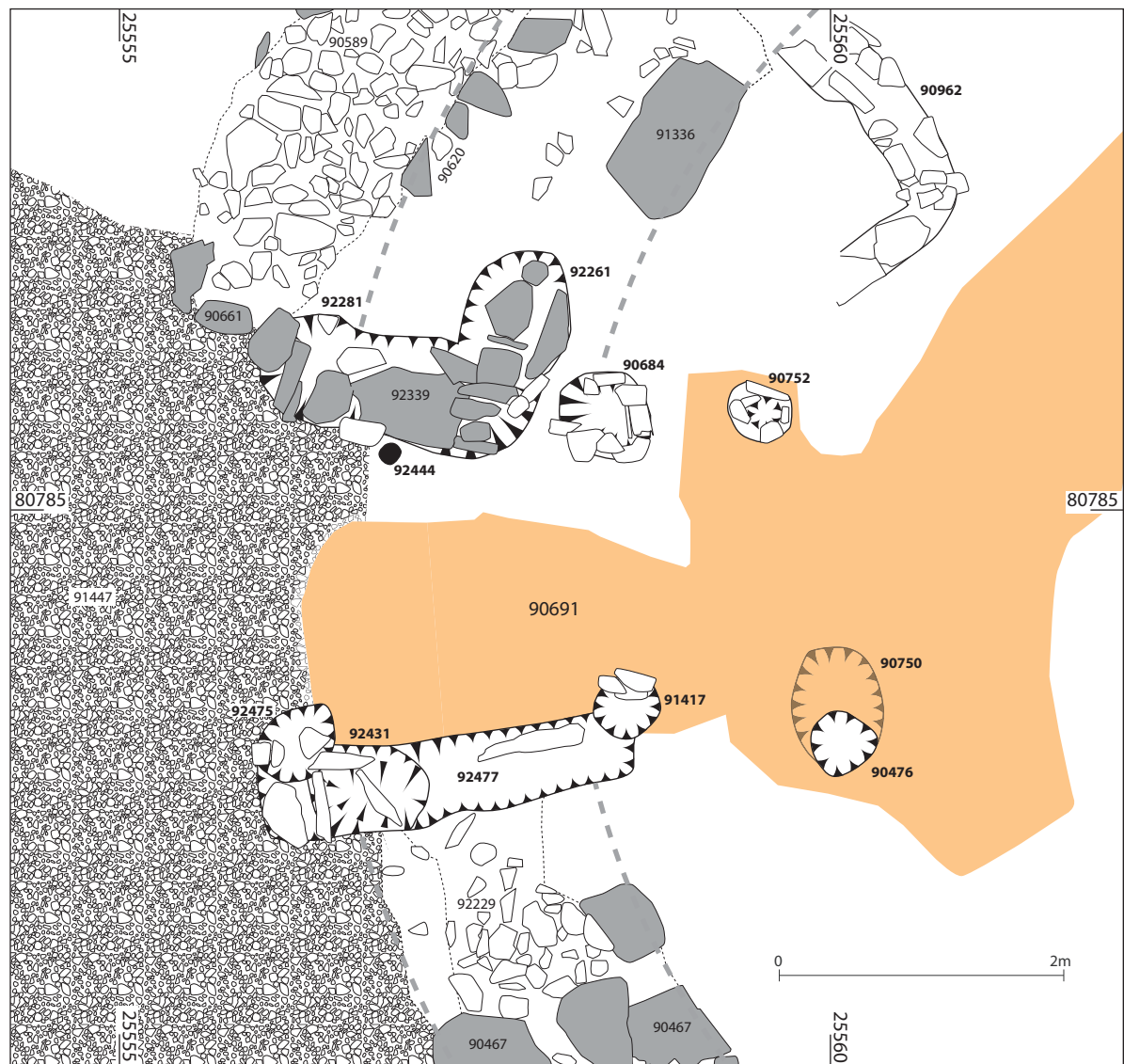

Figure 70.2. WNW facing section between roundhouse A and roundhouse E

For location of section see figures 68 and 75

- Key
- Facing stones and other significant stones
 - Stones
 - Charcoal
 - Upper floor layers
 - Lower floor layers
 - Hearths
 - Charcoal-rich layers
 - Soil/occupation layer over stone platform
 - Stone platform
 - Old ground surface

Figure 70. Sections through roundhouse A and between roundhouses A and E



Phase II

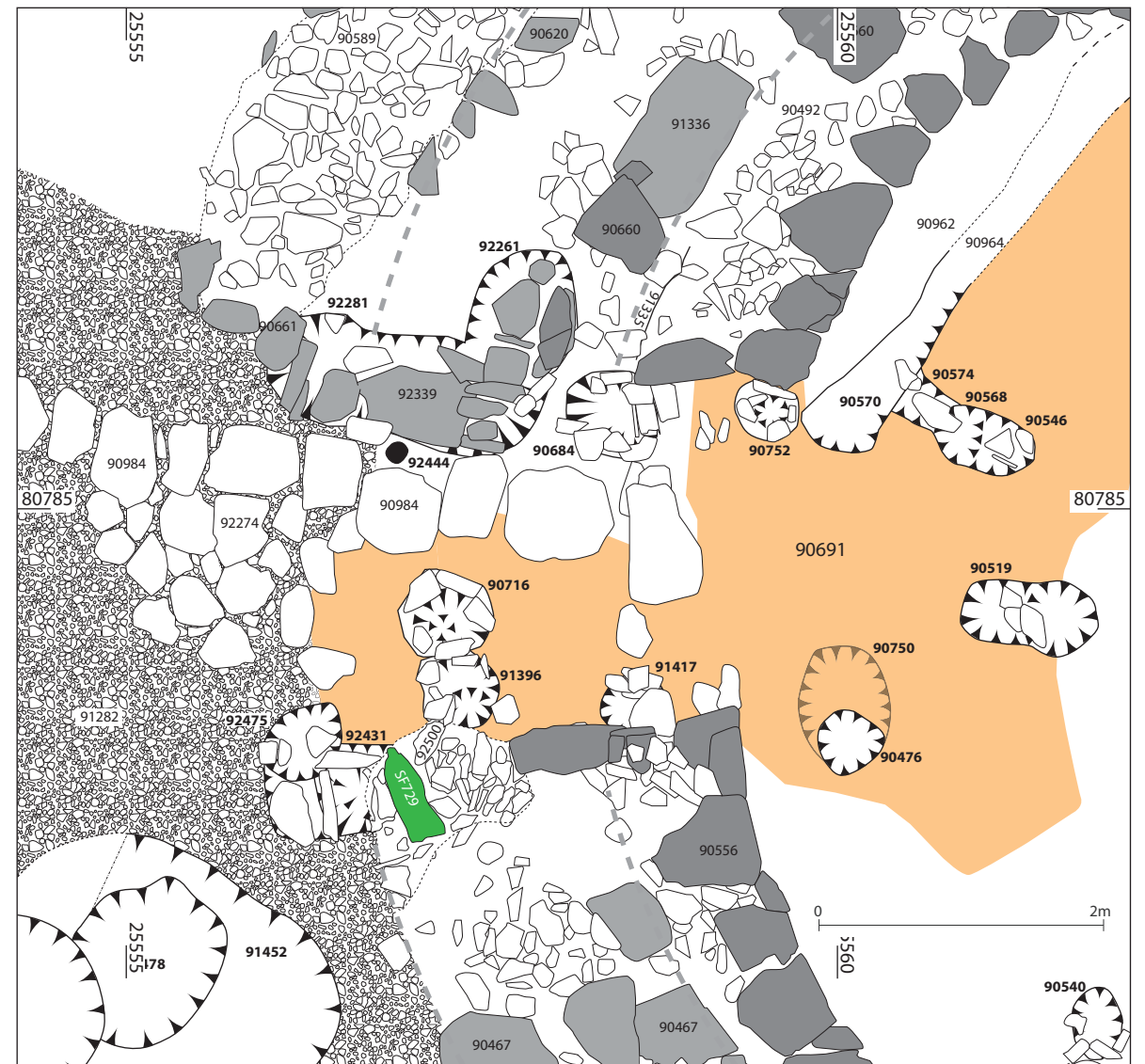

Phase III



- Key
- Floor deposit
 - Facing stone
 - Stone
 - Cobbled surface
 - Stone object

Figure 71. Details of the two phases of the porch of roundhouse A

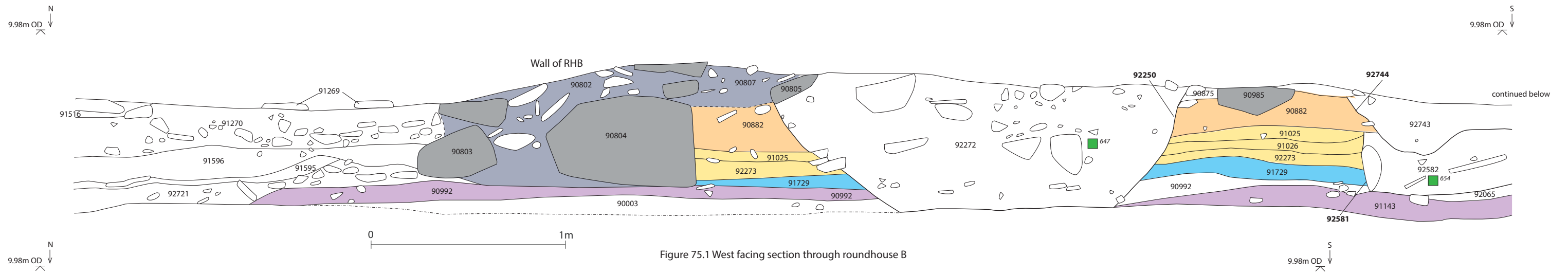
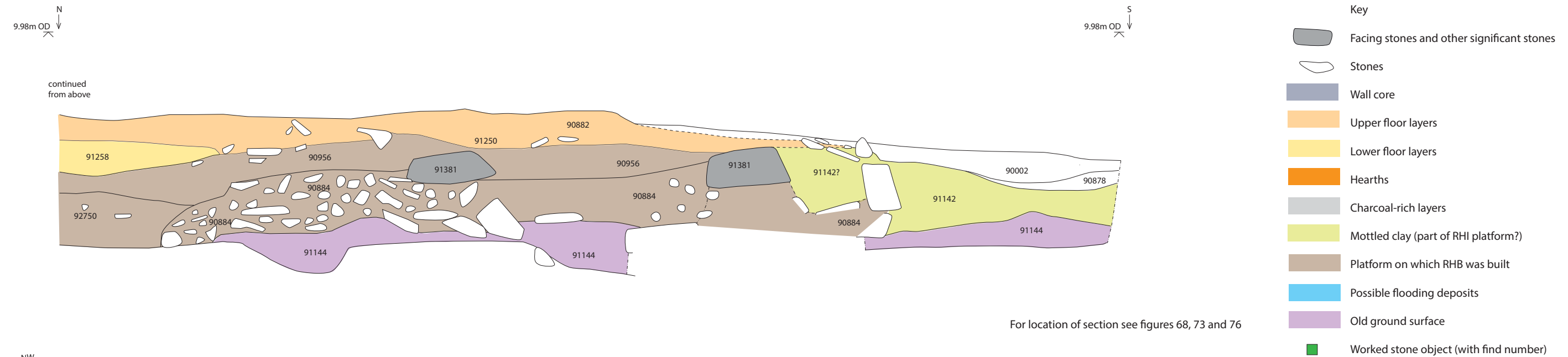
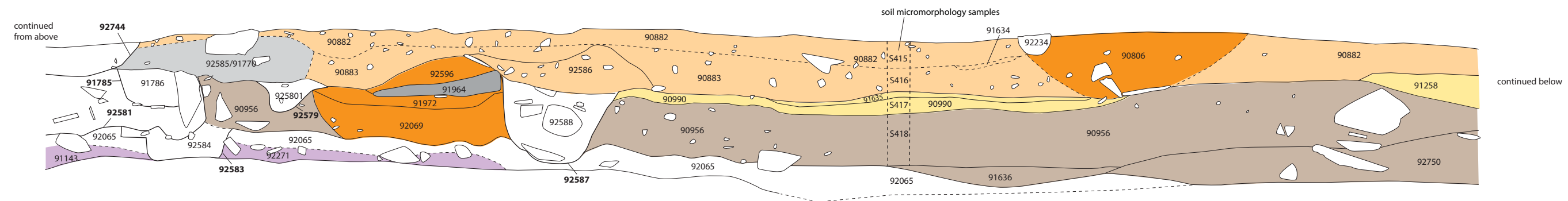

Figure 75.1 West facing section through roundhouse B



- Key
- Facing stones and other significant stones
 - Stones
 - Wall core
 - Upper floor layers
 - Lower floor layers
 - Hearths
 - Charcoal-rich layers
 - Mottled clay (part of RHI platform?)
 - Platform on which RHB was built
 - Possible flooding deposits
 - Old ground surface
 - Worked stone object (with find number)

For location of section see figures 68, 73 and 76

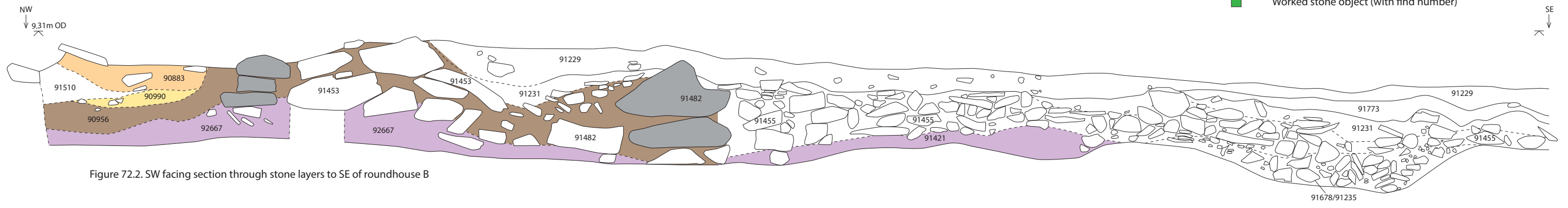

Figure 72.2. SW facing section through stone layers to SE of roundhouse B

Figure 72. Sections through roundhouse B and stone deposits to SE of roundhouse

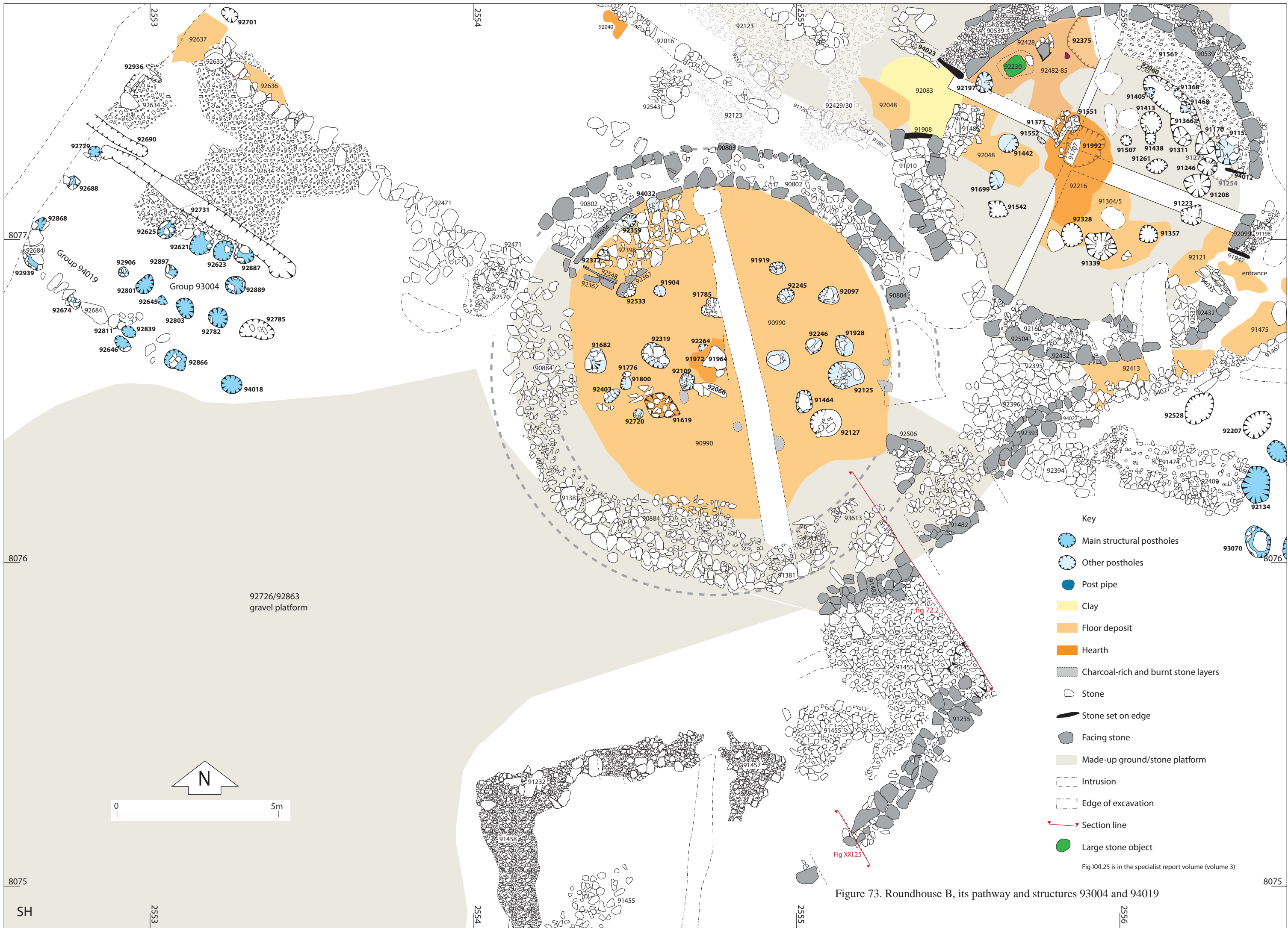
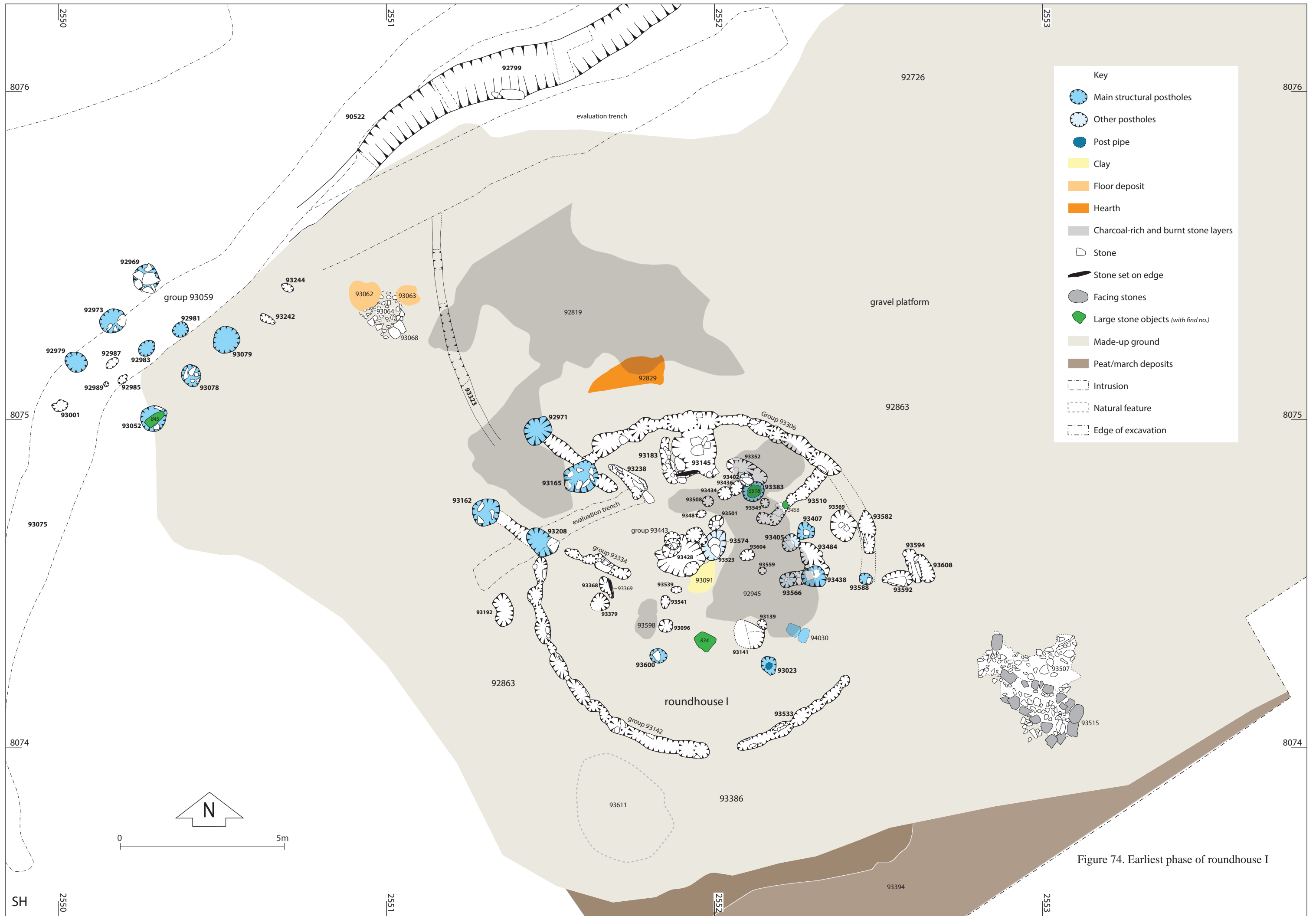

Figure 73. Roundhouse B, its pathway and structures 93004 and 94019



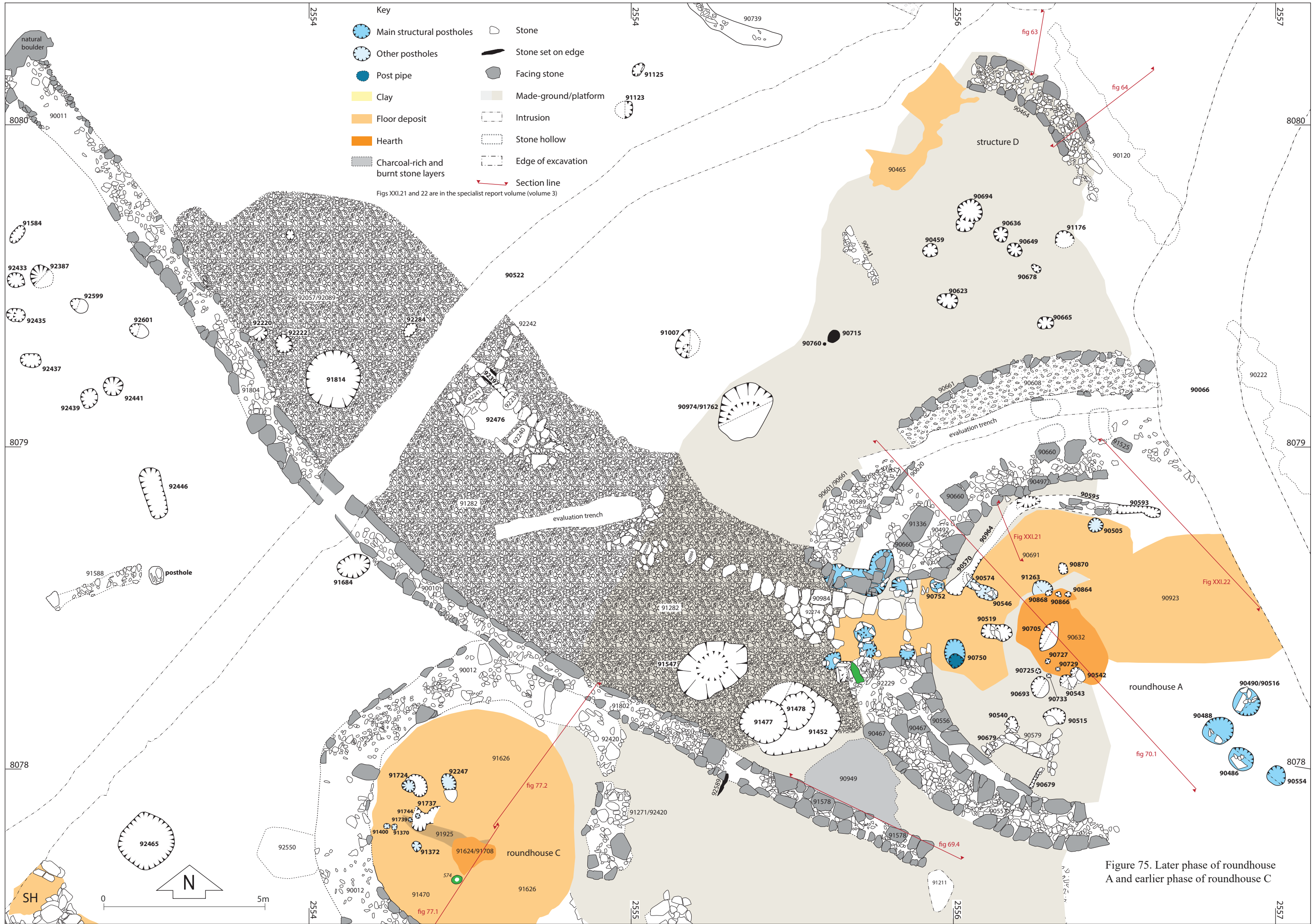



Figure 76. Later phases of roundhouse B and roundhouse C

- Key
- Main structural postholes
 - Other postholes
 - Post pipe
 - Clay
 - Floor deposit
 - Hearth
 - Charcoal-rich and burnt stone layers
 - Stone
 - Stone set on edge
 - Facing stone
 - Made-ground/platform
 - Intrusion
 - Natural feature
 - Edge of excavation
 - Section line

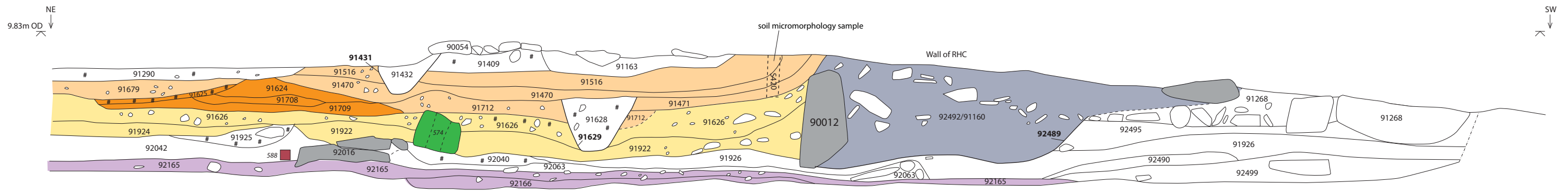

Figure 77.1. NW facing section of W quadrant of roundhouse C

- Key
- Facing stones and other significant stones
 - Stones
 - Wall core
 - Upper floor layers
 - Lower floor layers
 - Hearths
 - Charcoal-rich layers
 - Stone platform
 - Old ground surface
 - Worked stone object (with *find number*)

0 1m

For location of sections see figures 75 and 76

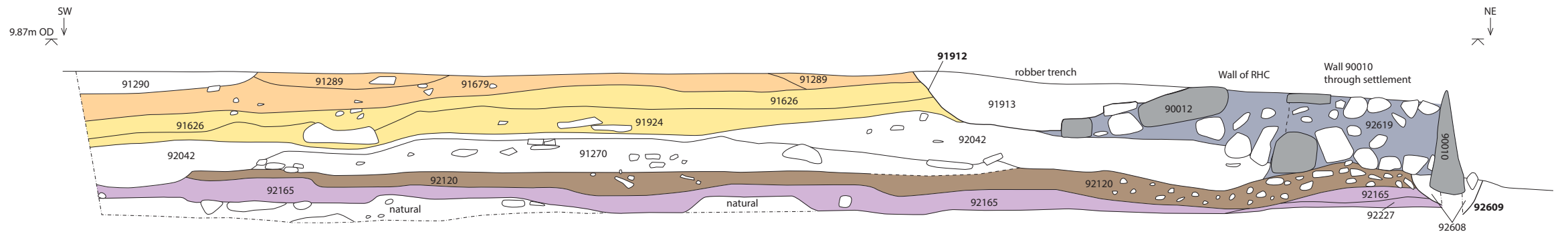

Figure 77.2. SE facing section of E quadrant of roundhouse C

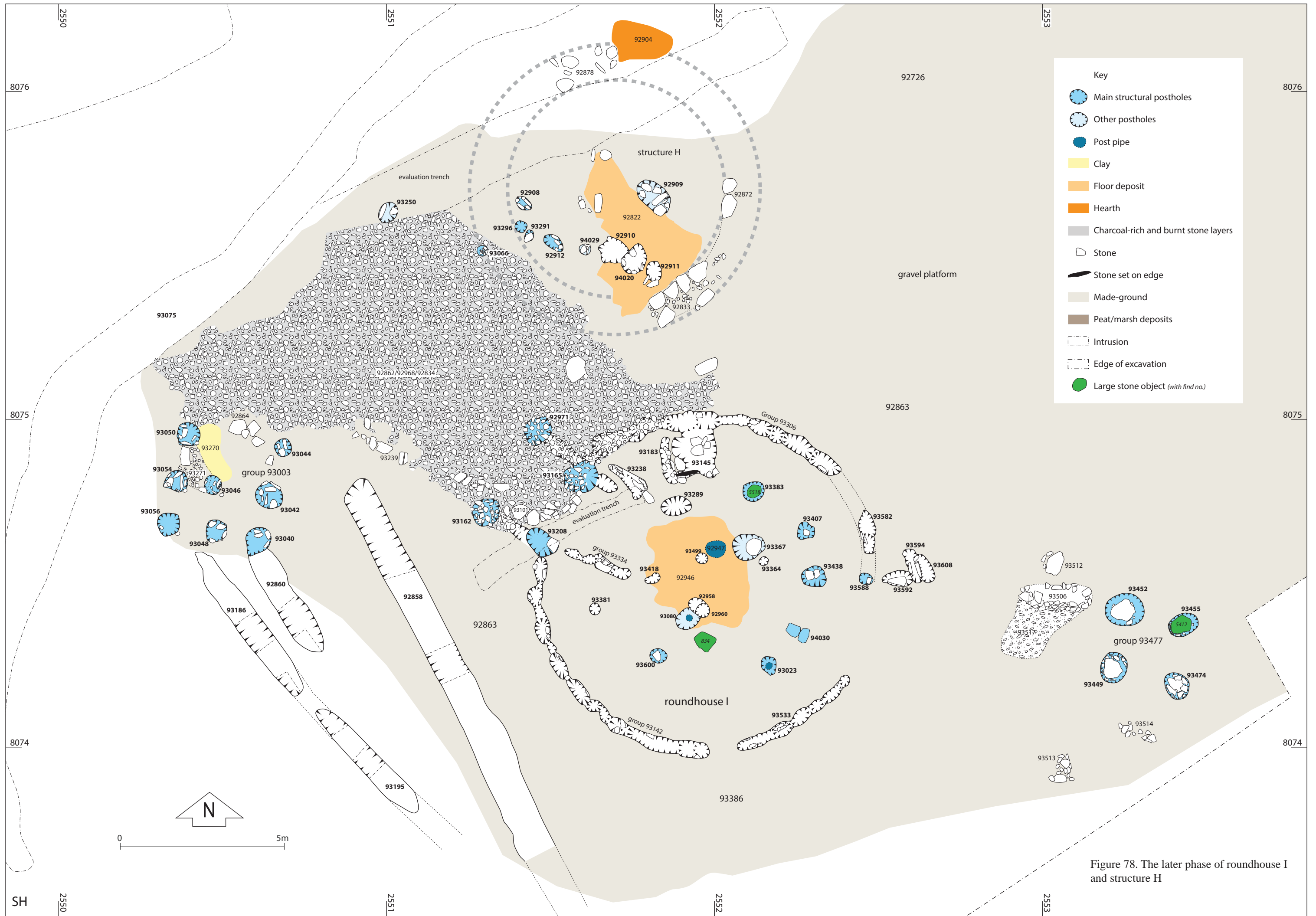
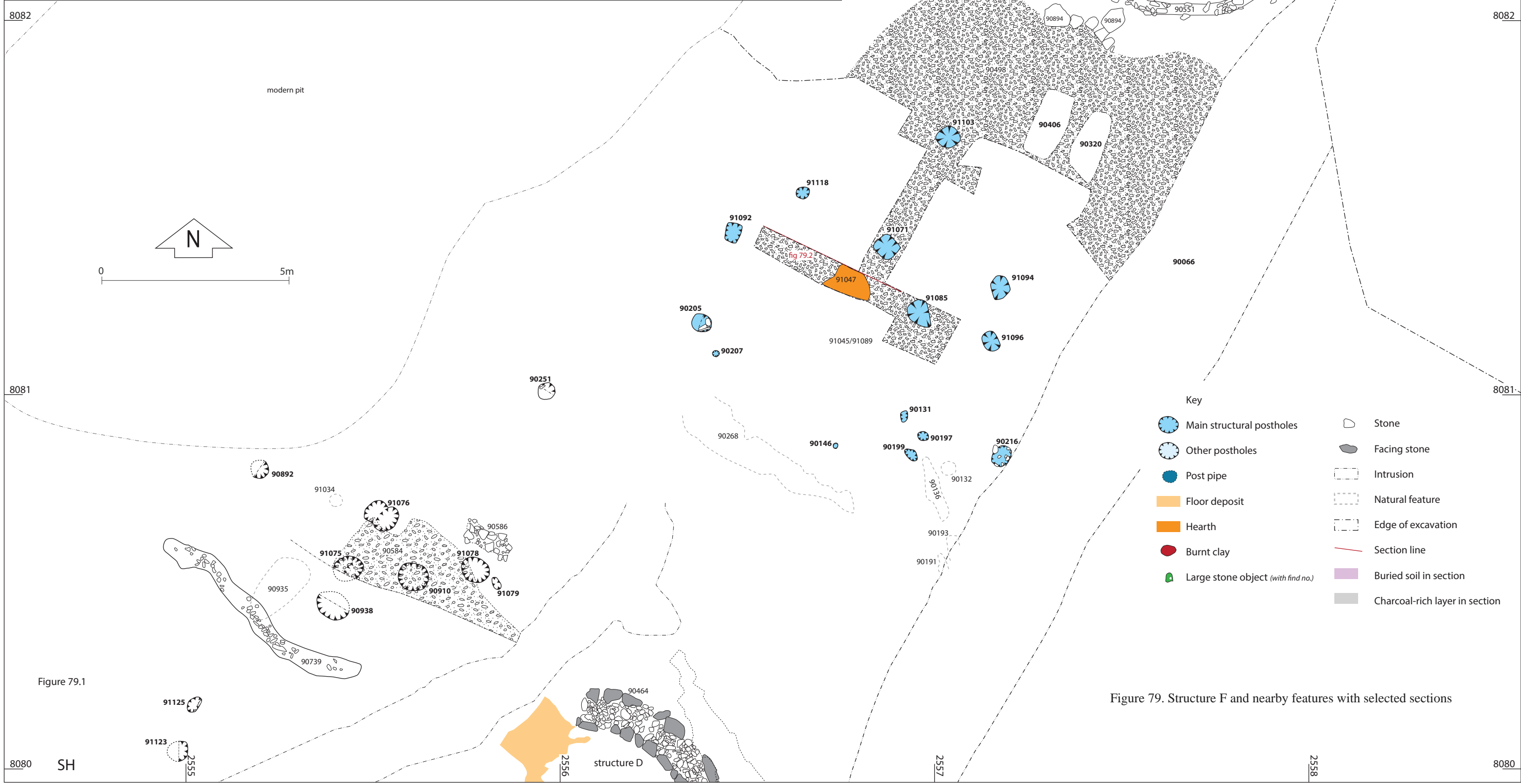
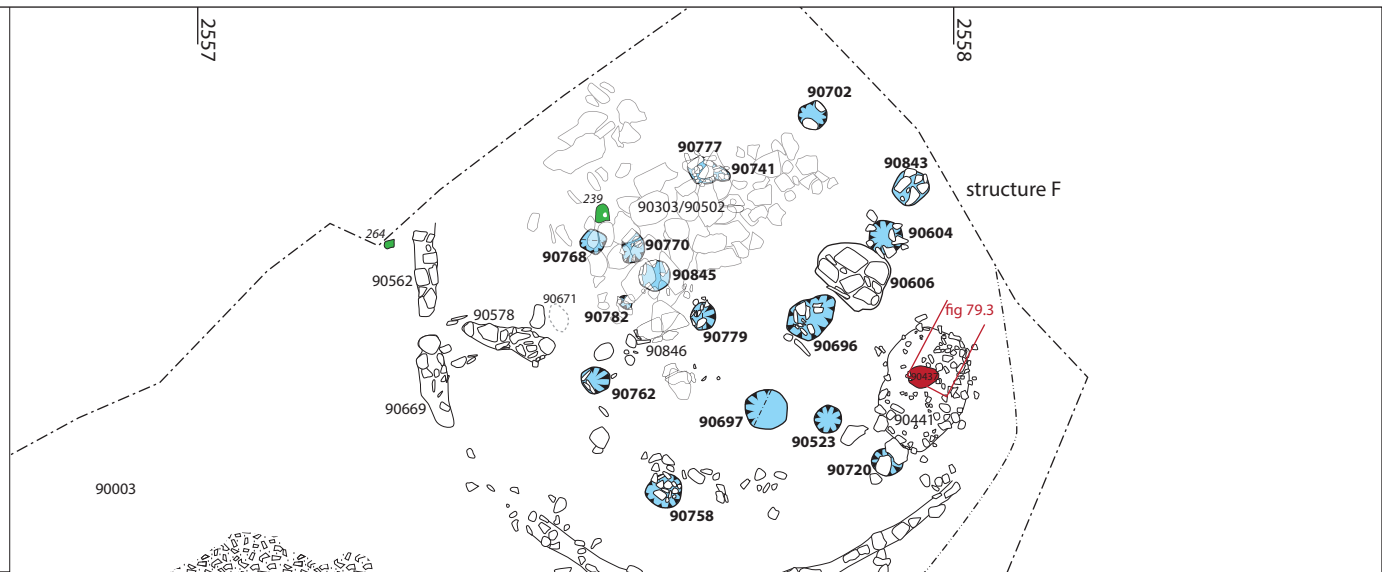
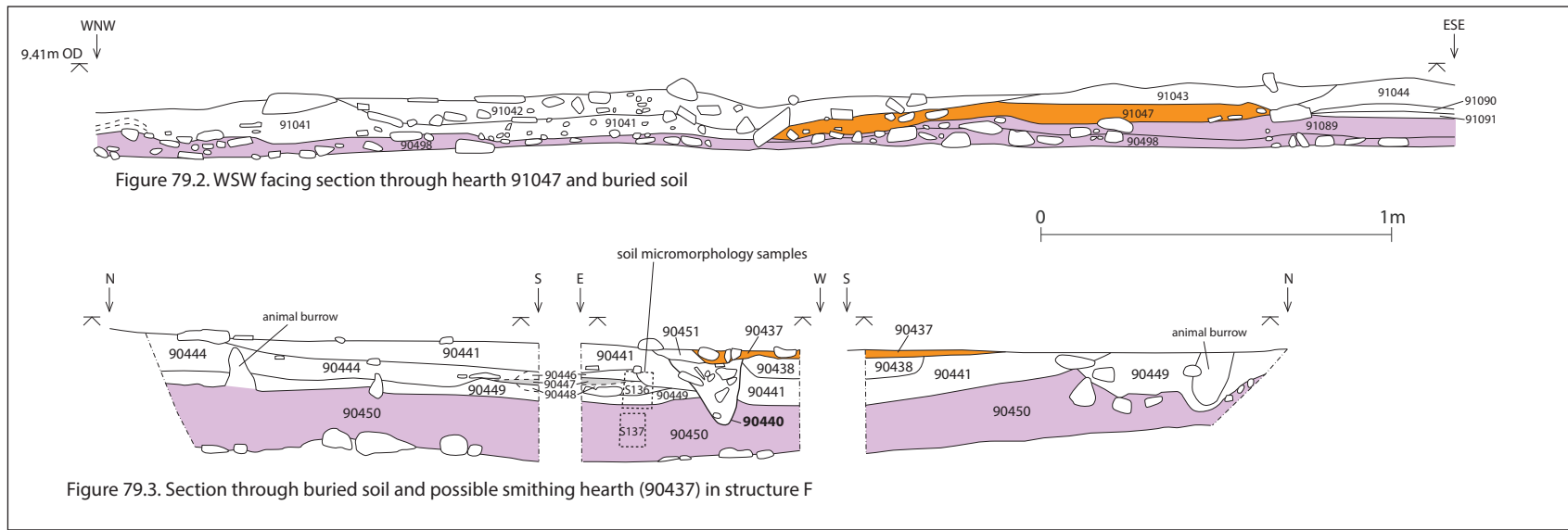

Figure 78. The later phase of roundhouse I and structure H



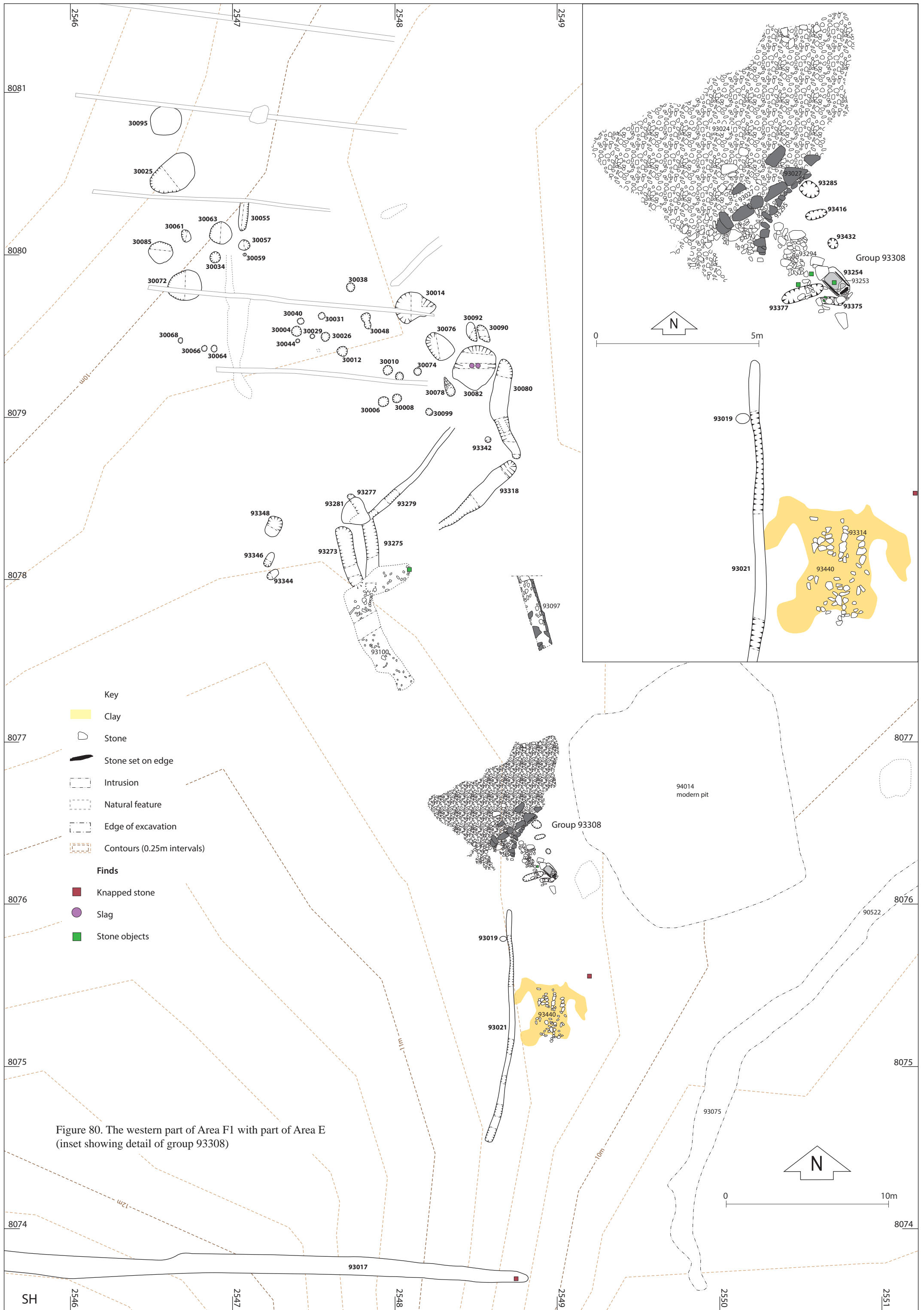
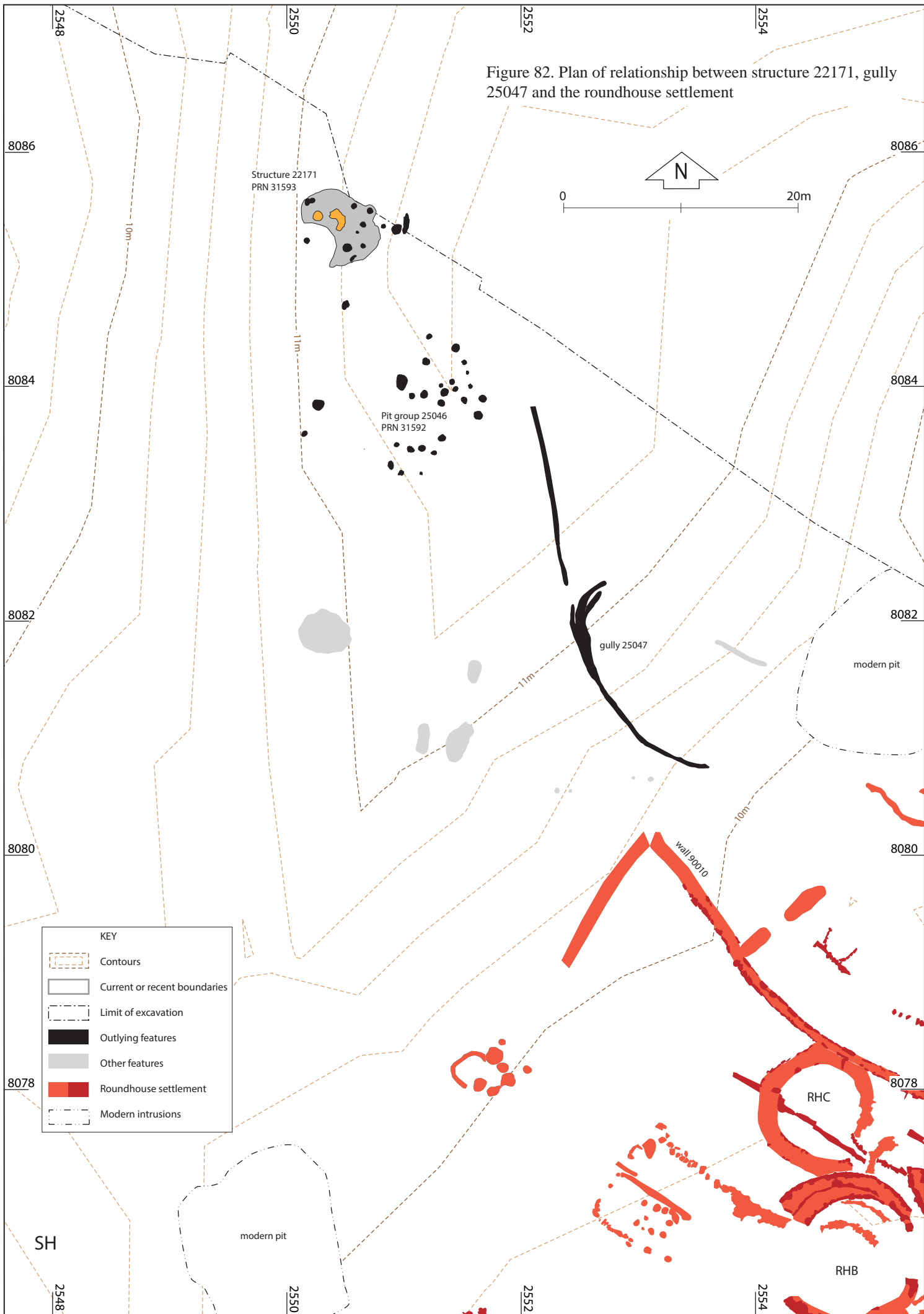



Figure 81. Distribution of finds from the roundhouse settlement

Figure 82. Plan of relationship between structure 22171, gully 25047 and the roundhouse settlement



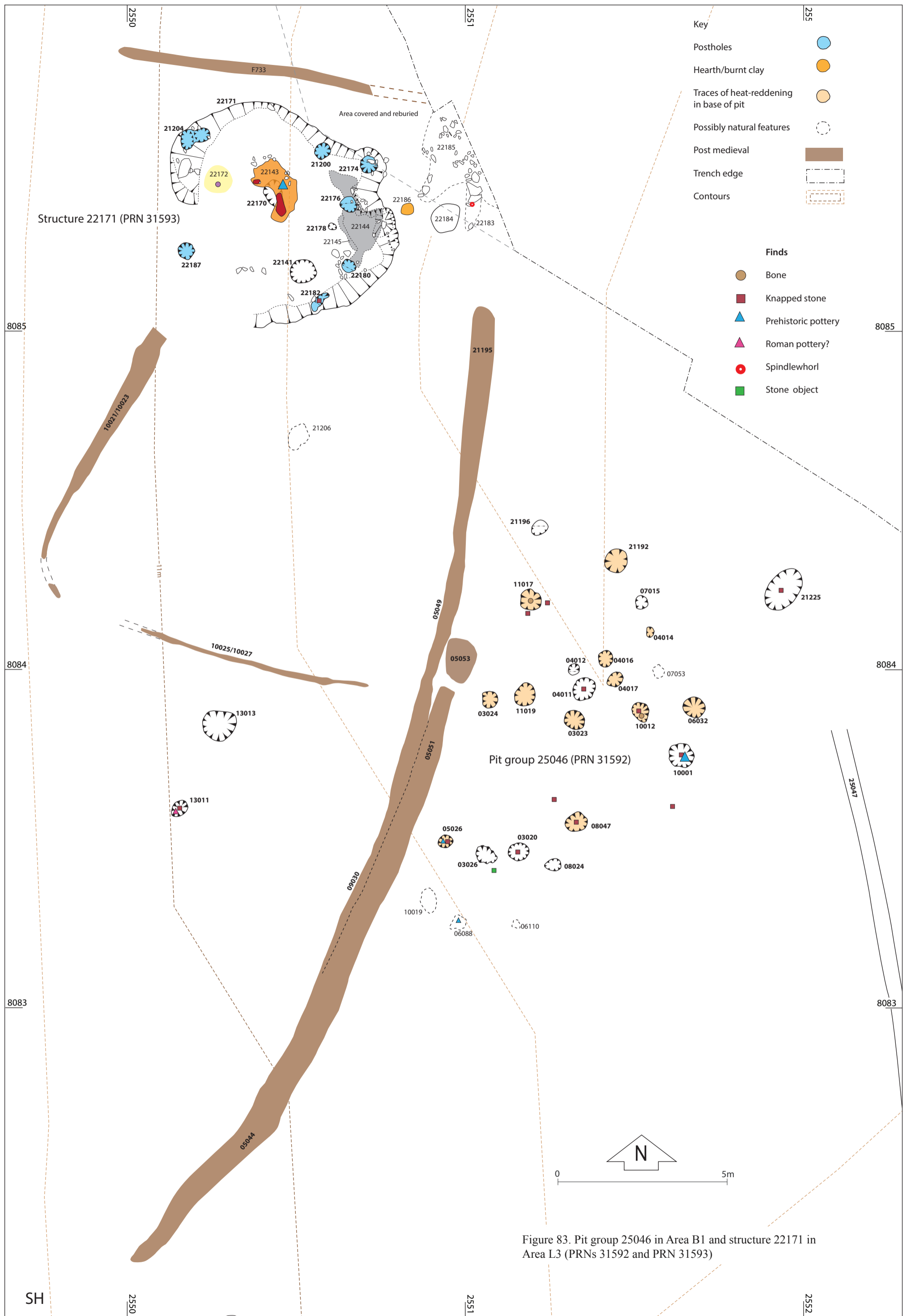
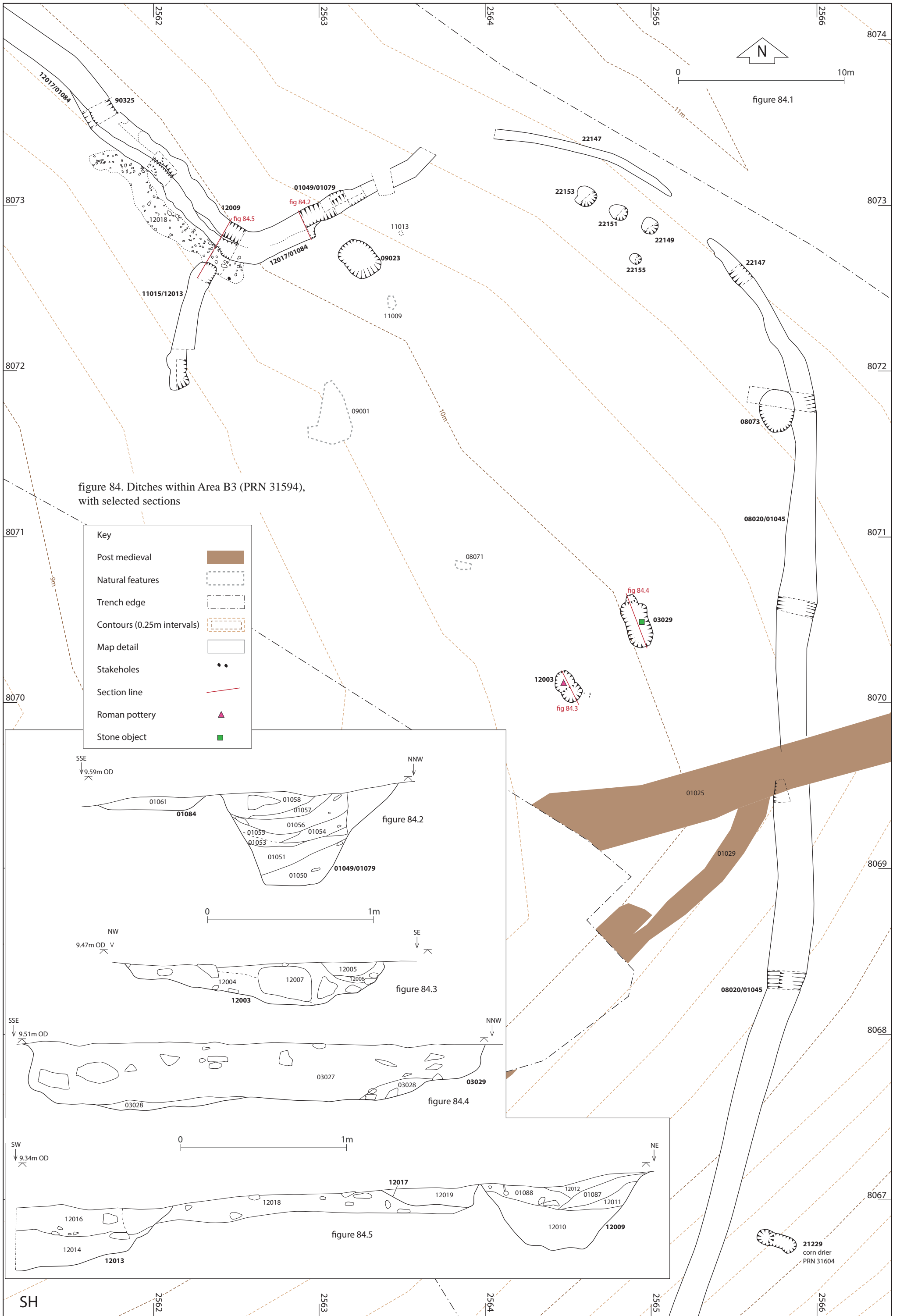
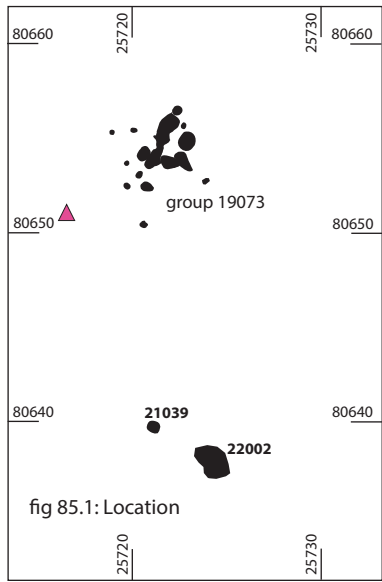

Figure 83. Pit group 25046 in Area B1 and structure 22171 in Area L3 (PRNs 31592 and PRN 31593)





- Key
- Clay patch
 - Natural hollow
 - Section line
 - Stone
 - ## Charcoal
 - Stone object
 - Roman pot
 - Spindlewhorl

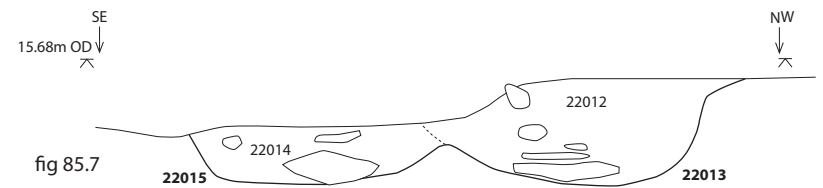
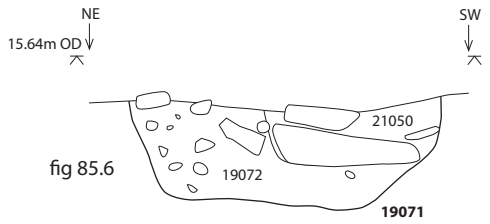
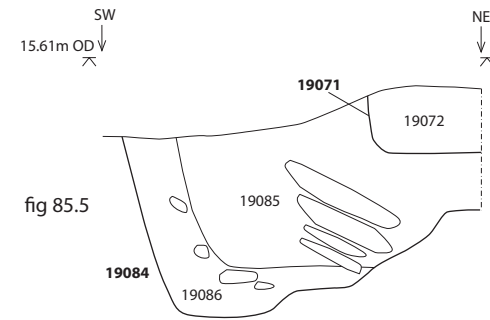
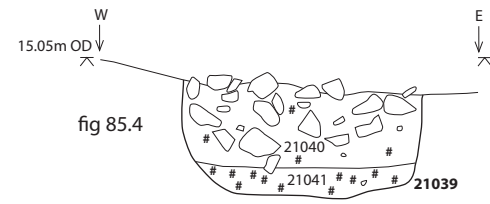
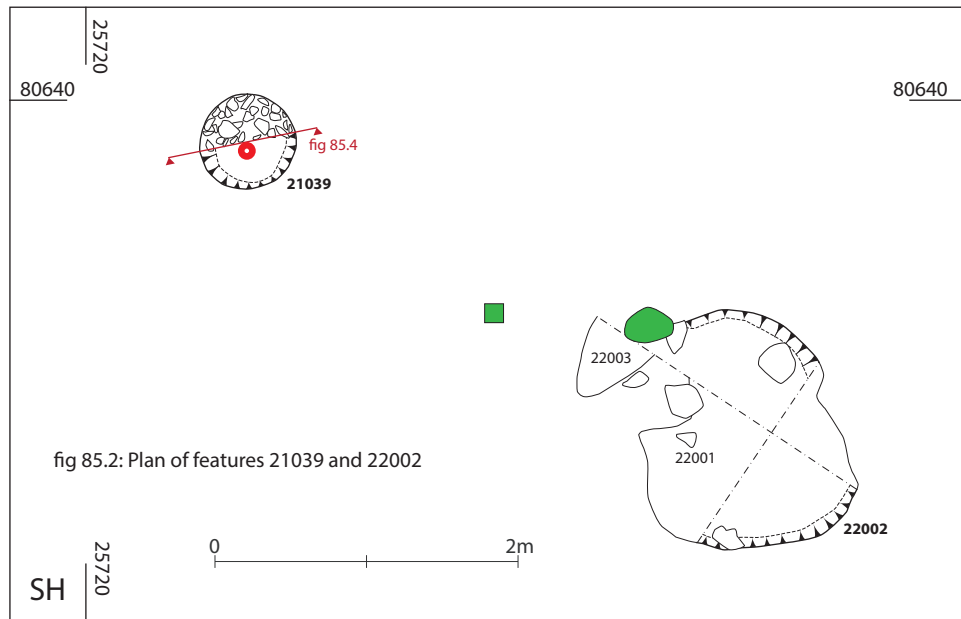

Figure 85. Plans and sections of pit group 19073 and neighbouring features (PRN 31598)

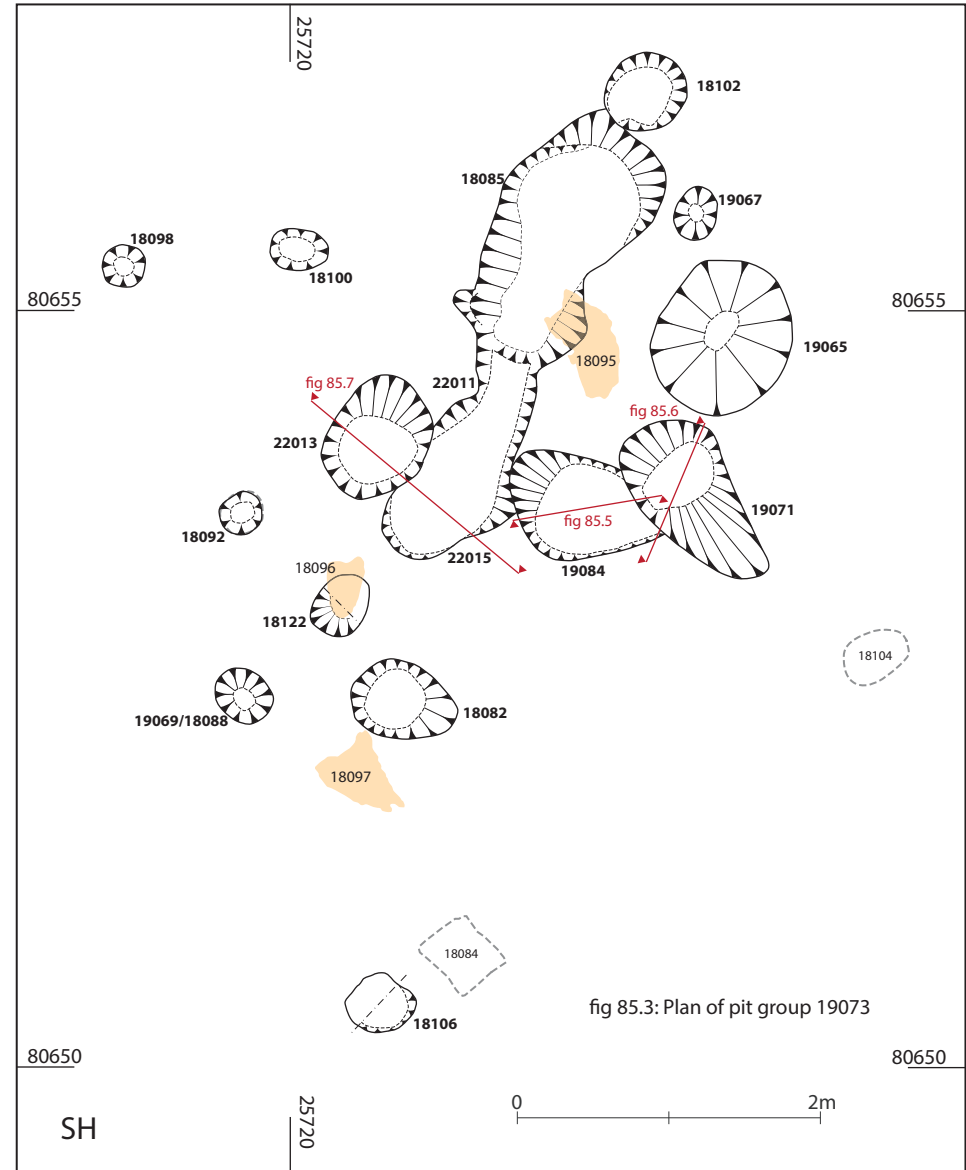
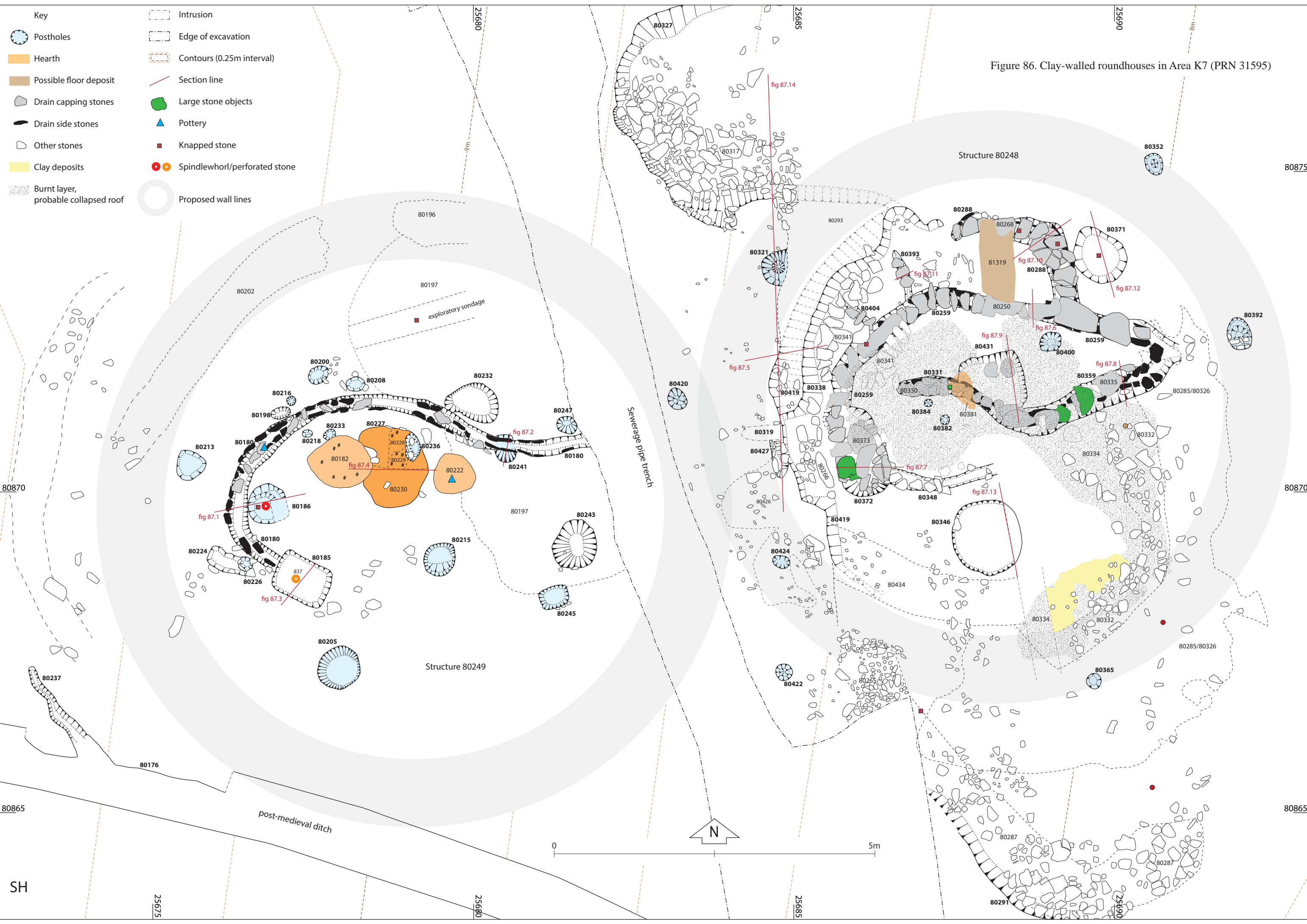

Figure 86. Clay-walled roundhouses in Area K7 (PRN 31595)



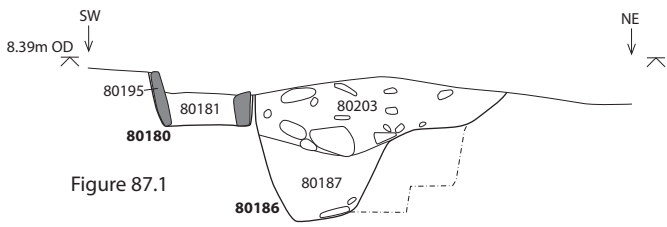

Figure 87.1

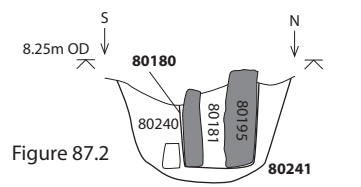

Figure 87.2

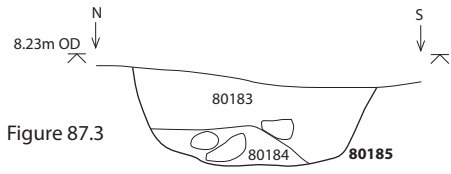

Figure 87.3

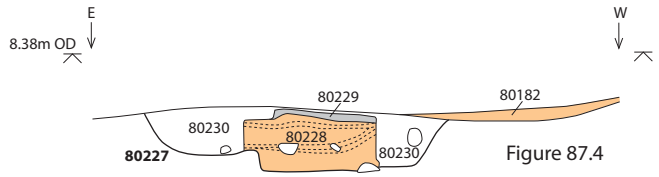

Figure 87.4

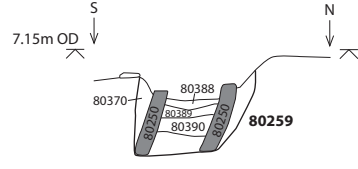

Figure 87.6

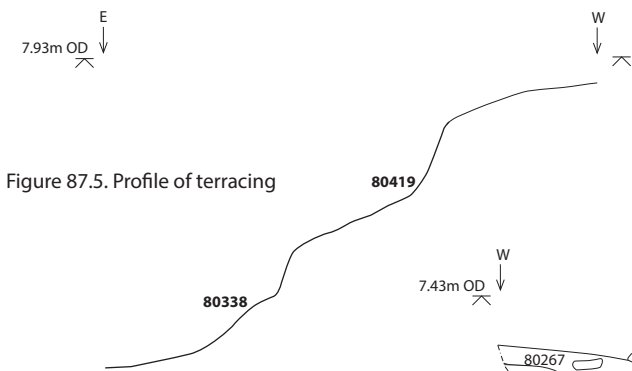
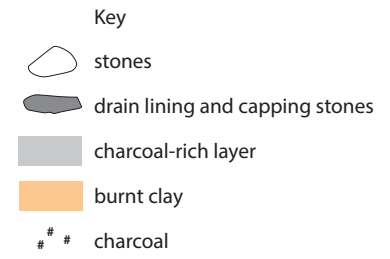

Figure 87.5. Profile of terracing



For location of sections see figure 86

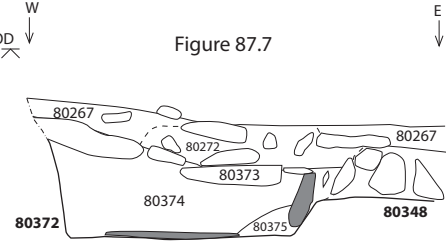

Figure 87.7

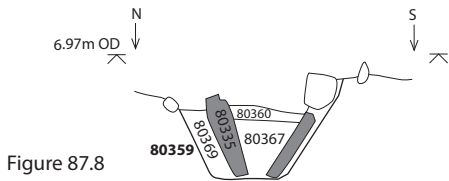

Figure 87.8

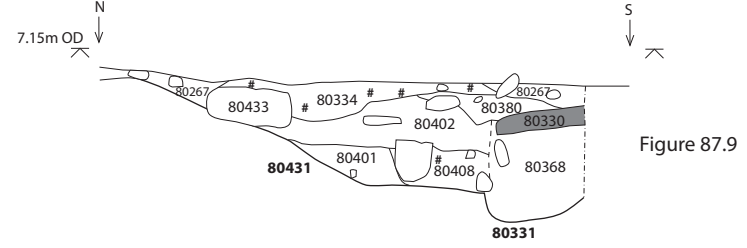

Figure 87.9

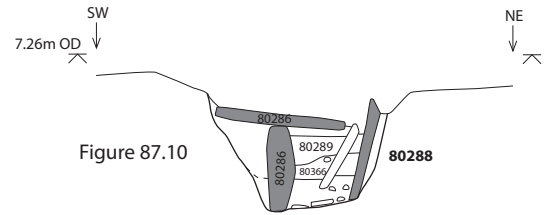

Figure 87.10

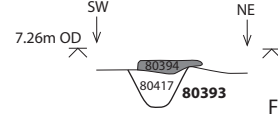

Figure 87.11

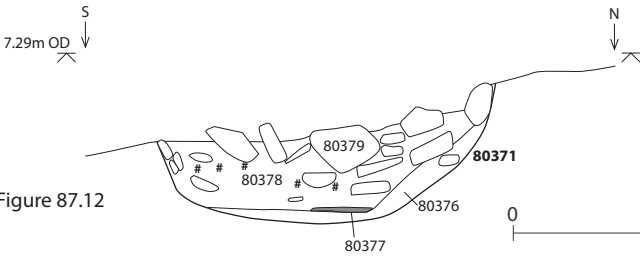

Figure 87.12

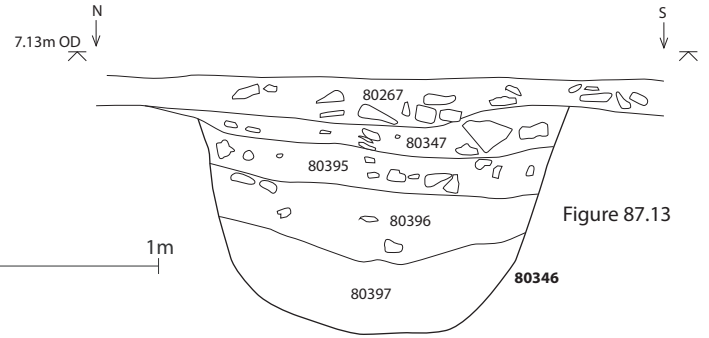

Figure 87.13

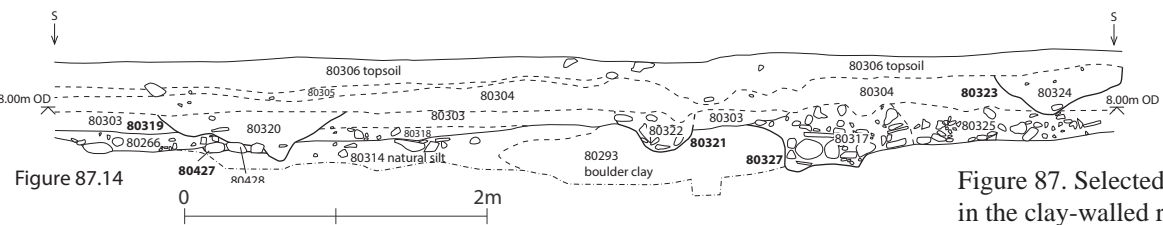

Figure 87.14



Figure 87. Selected sections of features in the clay-walled roundhouses

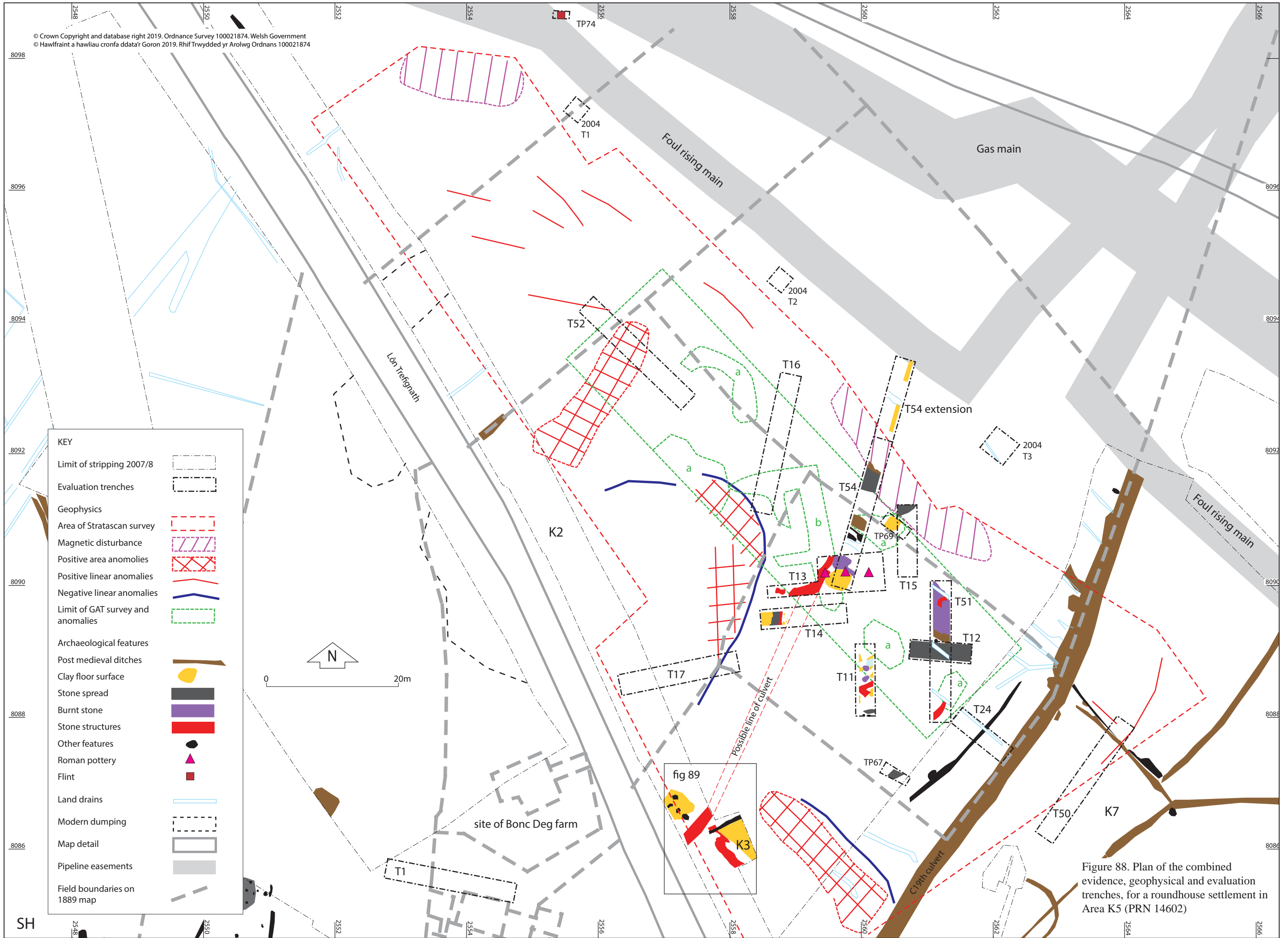
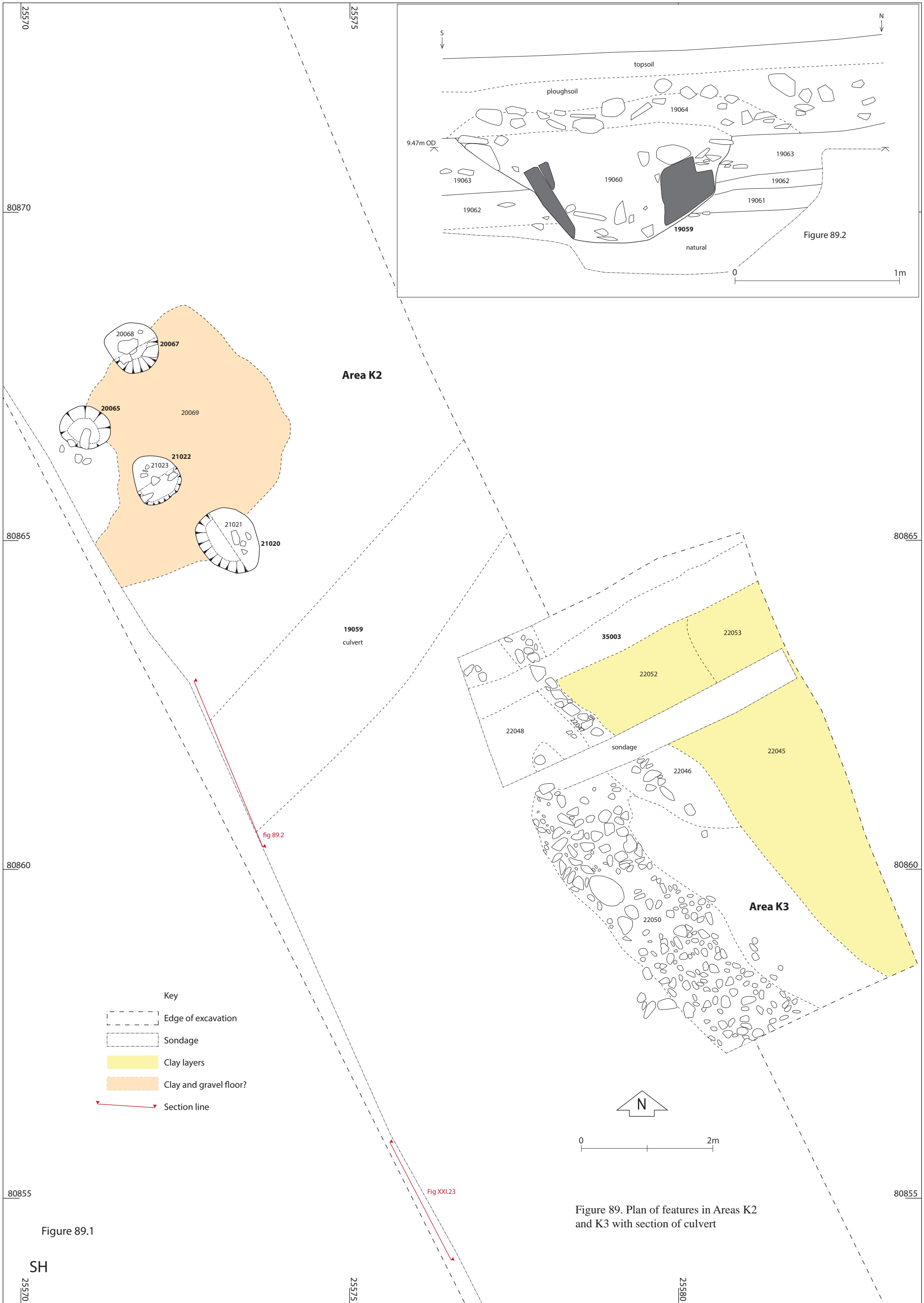
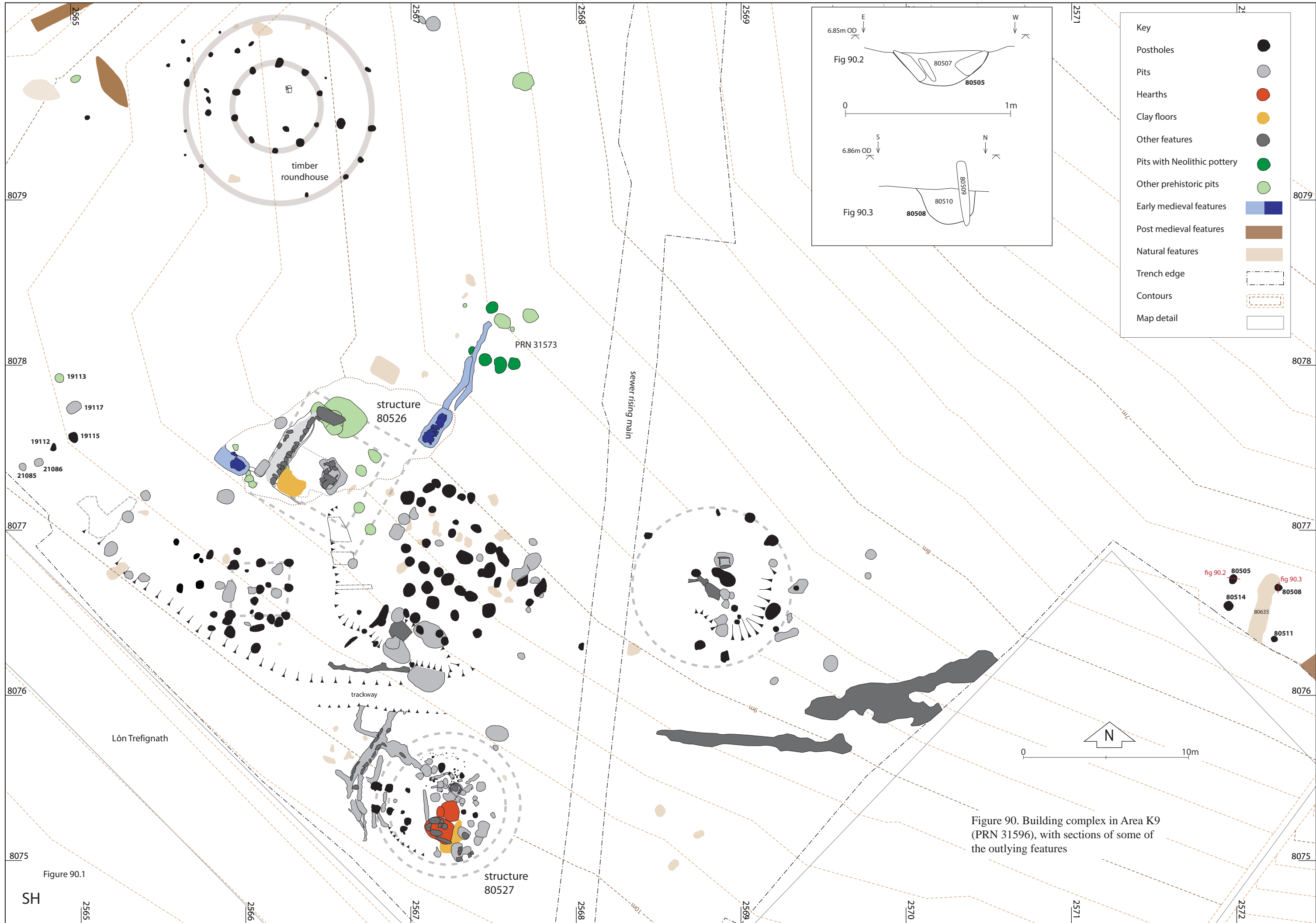

Figure 88. Plan of the combined evidence, geophysical and evaluation trenches, for a roundhouse settlement in Area K5 (PRN 14602)





Key	
Postholes	●
Pits	○
Hearths	●
Clay floors	●
Other features	●
Pits with Neolithic pottery	●
Other prehistoric pits	○
Early medieval features	■
Post medieval features	■
Natural features	■
Trench edge	—
Contours	- - -
Map detail	□

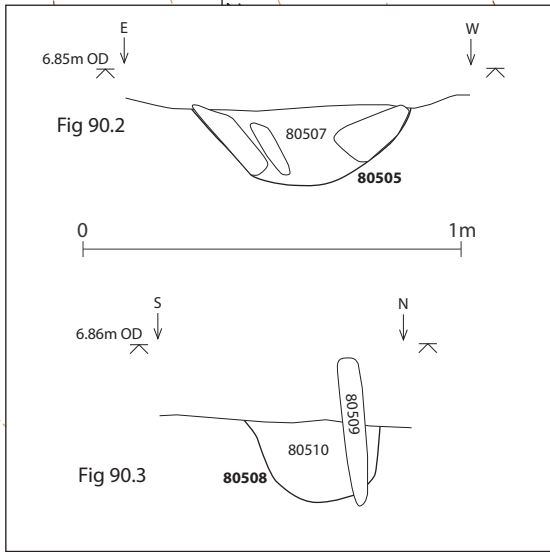

Figure 90. Building complex in Area K9 (PRN 31596), with sections of some of the outlying features

Figure 90.1
SH

Lôn Trefignath

structure 80527

trackway

structure 80526

PRN 31573

sewer rising main

timber roundhouse

N

0 10m

8079

8078

8077

8076

8075

2565

2567

2568

2569

2571

2572

21085

21086

19113

19117

19112

19115

fig 90.2 80505

80514

fig 90.3 80508

80635

80511

8079

8078

8077

8076

8075

2572

2571

2570

2569

2568

2567

2566

2565

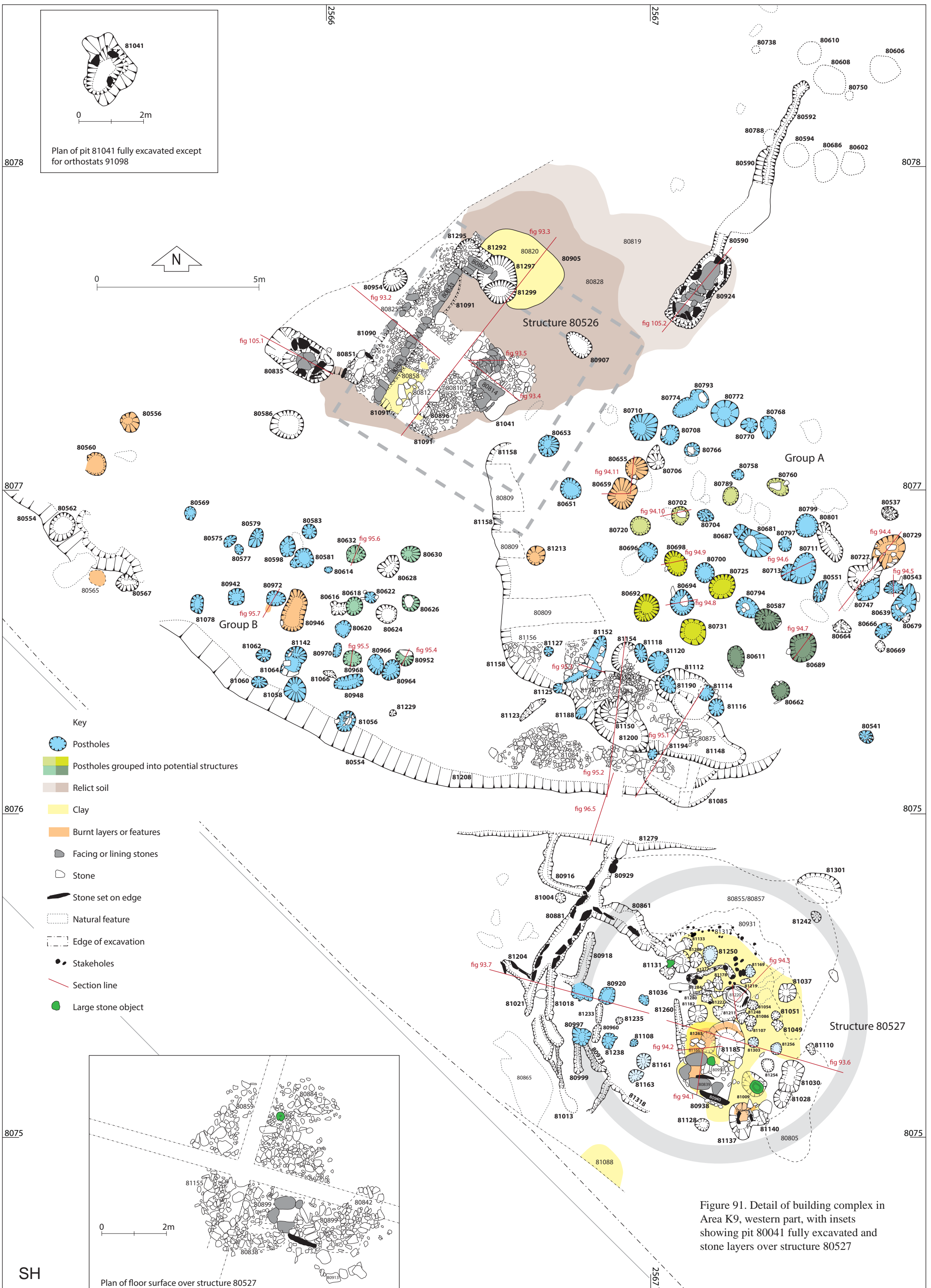

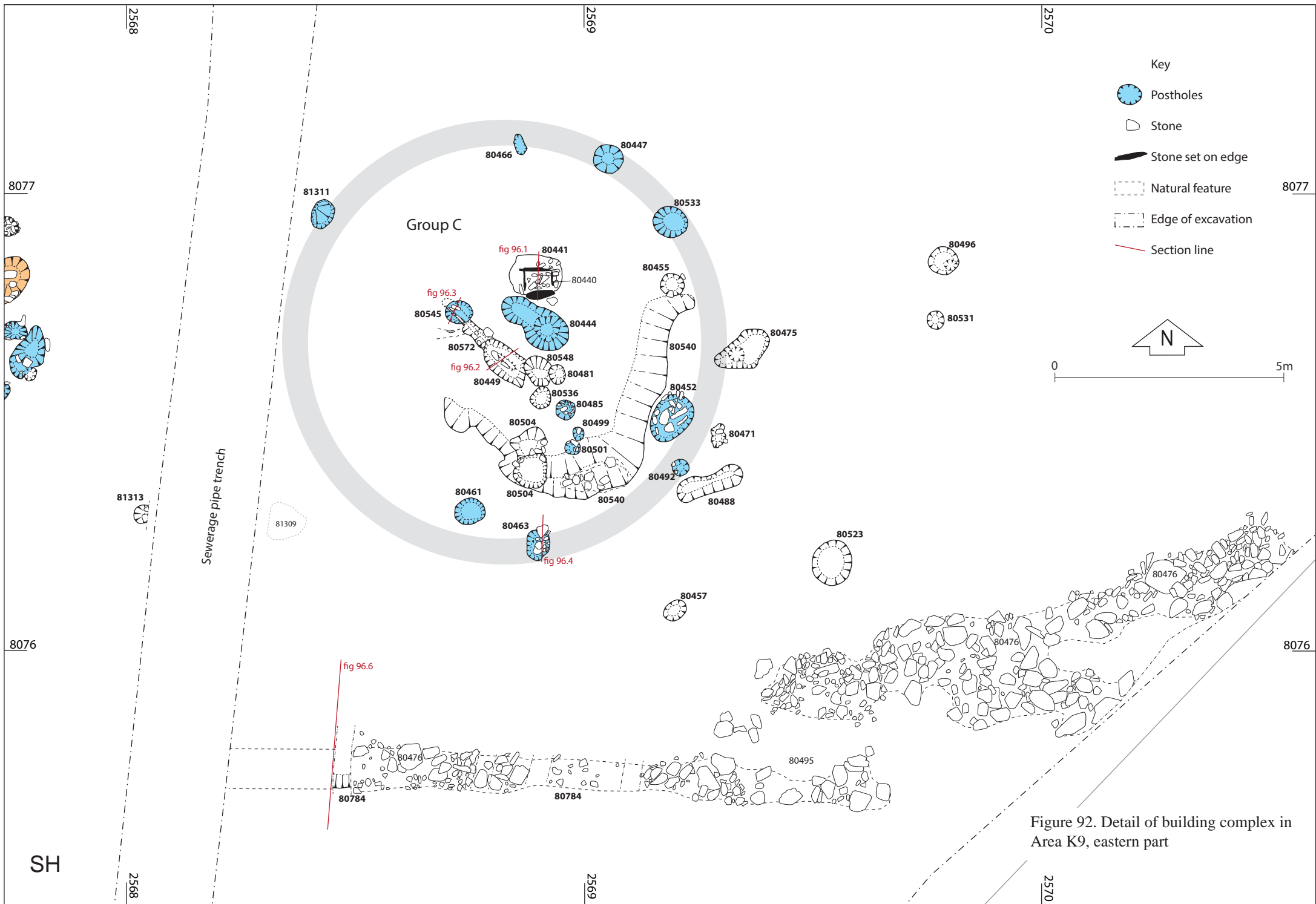

Figure 92. Detail of building complex in Area K9, eastern part

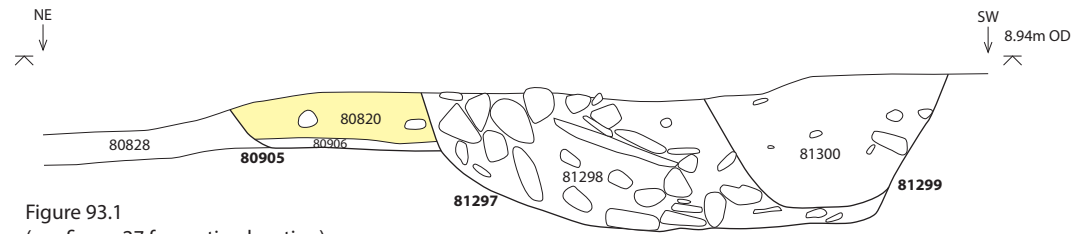

Figure 93.1
(see figure 27 for section location)

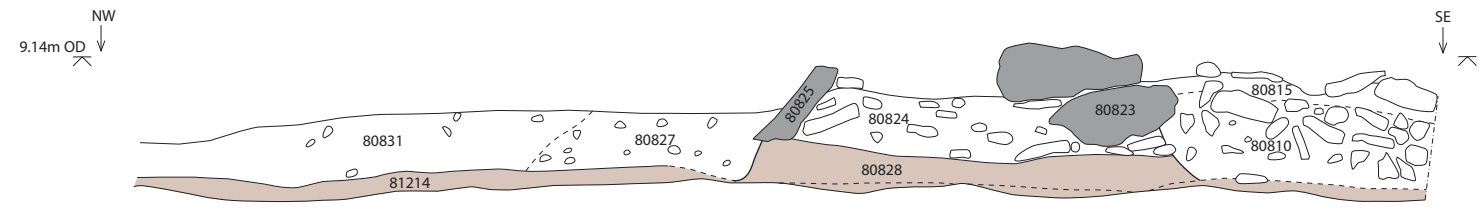

Figure 93.2

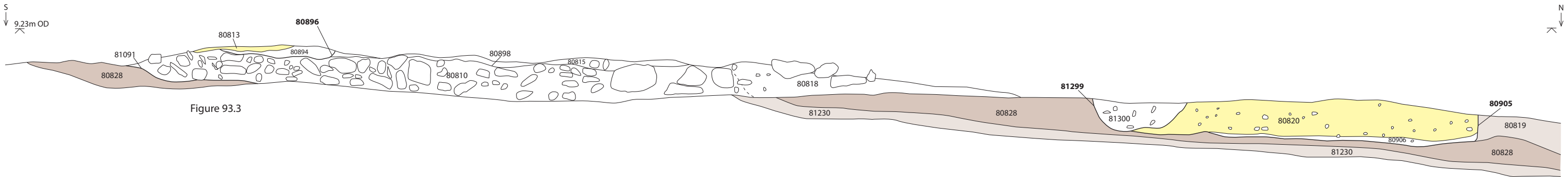

Figure 93.3

0 1m

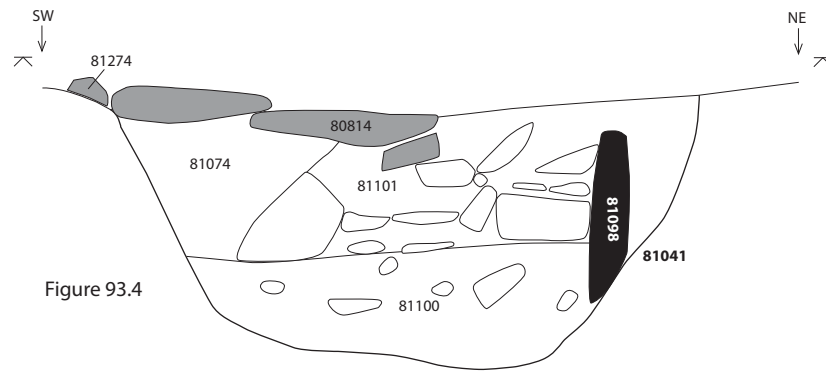

Figure 93.4

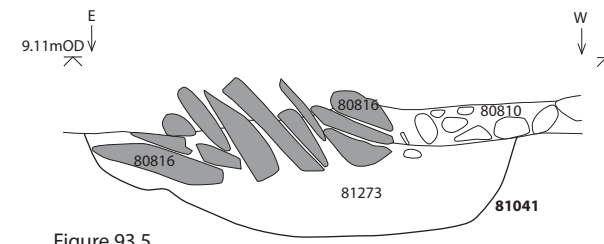









Figure 93.5

For section location see figure 91, except for fig 93.1

Figure 93. Selected sections of the building complex in Area K9

- Key
-  stone
 -  significant stone
 -  stone on edge
 -  clay
 -  hearth
 -  charcoal-rich layer
 -  relict soil

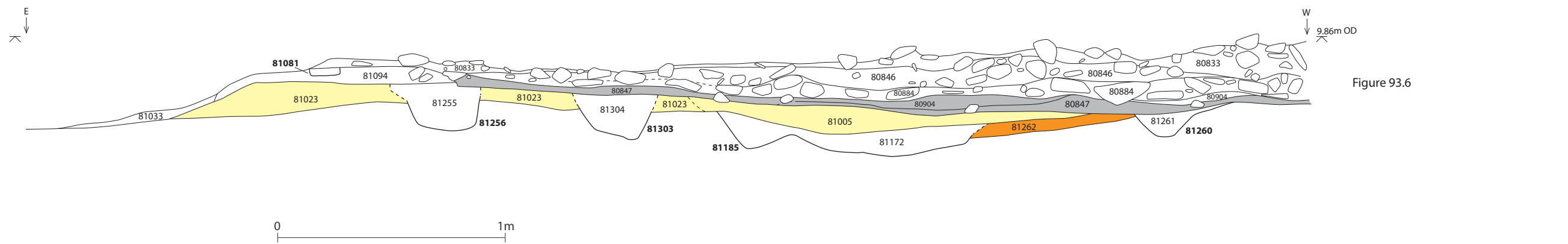

Figure 93.6

0 1m

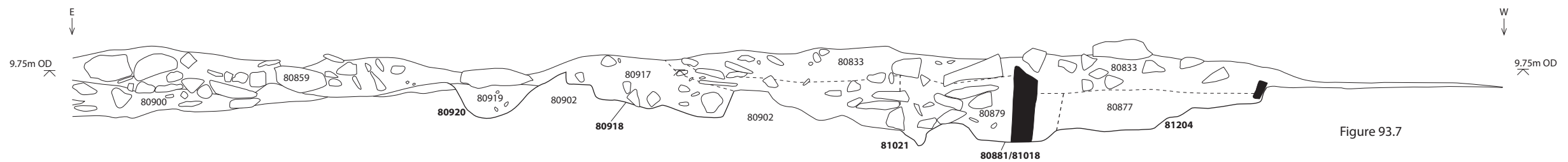
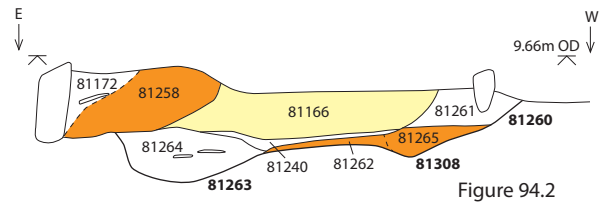
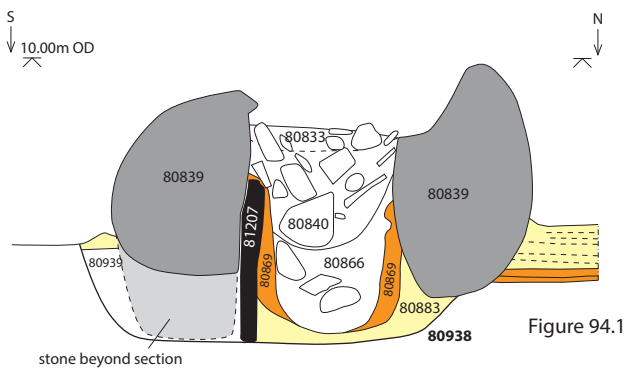







Figure 93.7



0 1m

- Key
-  stone
 -  significant stone
 -  stone on edge
 -  clay
 -  hearth/burnt clay

For section location see figure 91

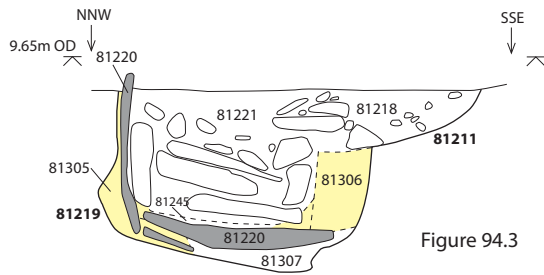

Figure 94.3

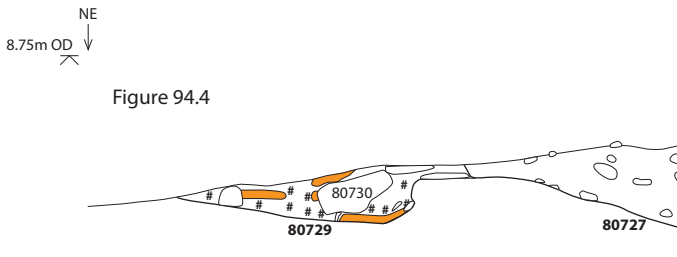

Figure 94.4

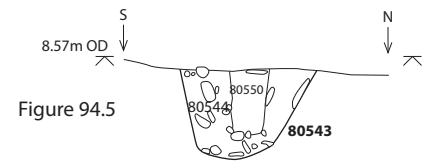

Figure 94.5

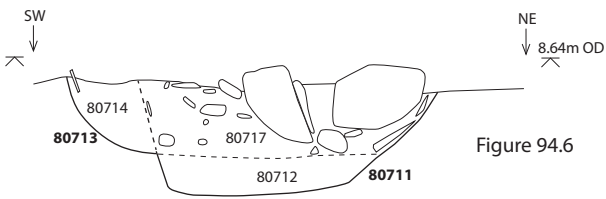

Figure 94.6

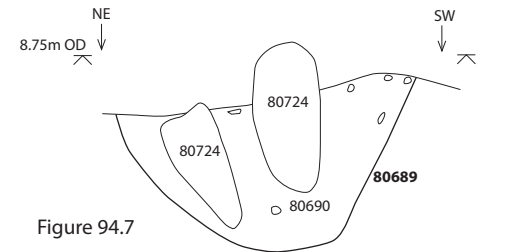

Figure 94.7

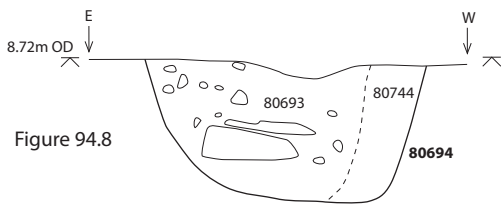

Figure 94.8

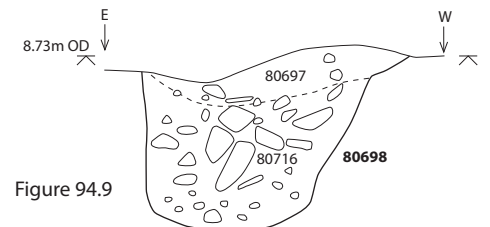

Figure 94.9

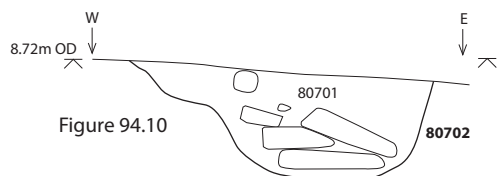

Figure 94.10

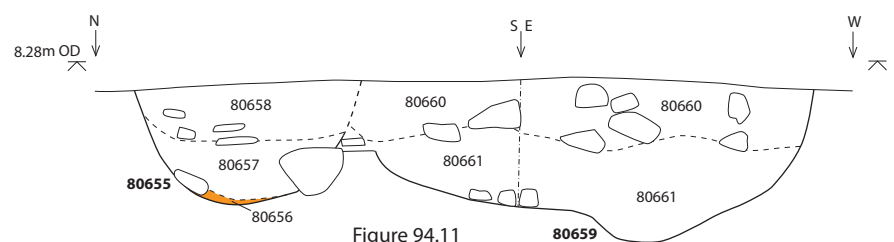
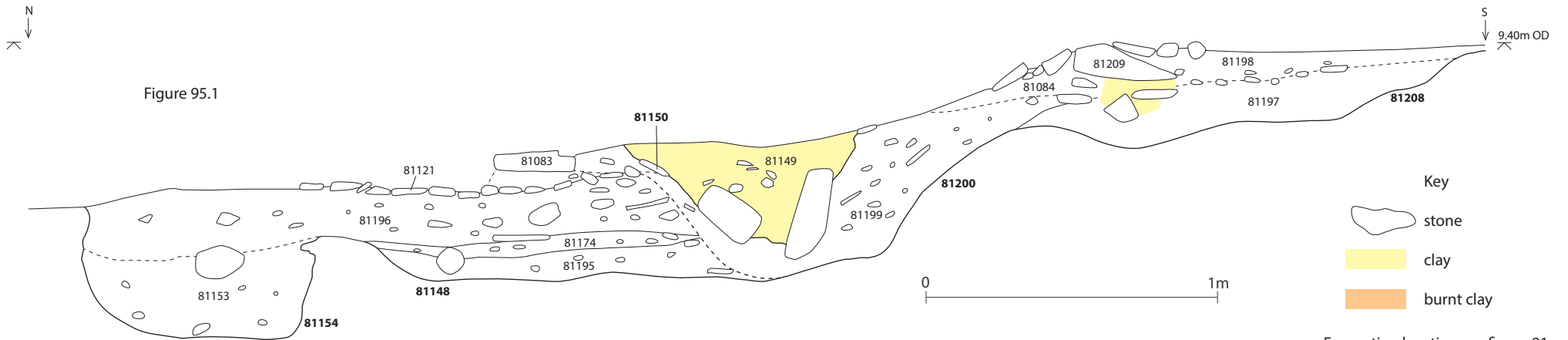

Figure 94.11

Figure 94. Selected sections of the building complex in Area K9



For section location see figure 91

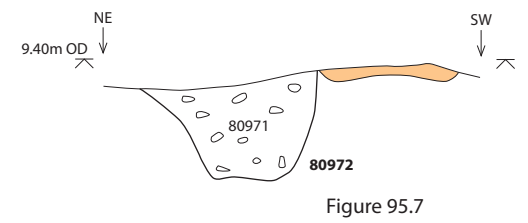
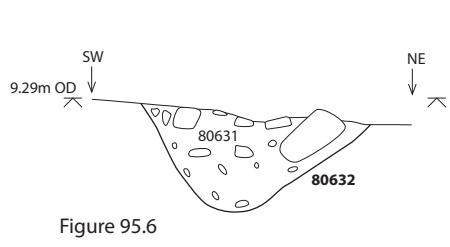
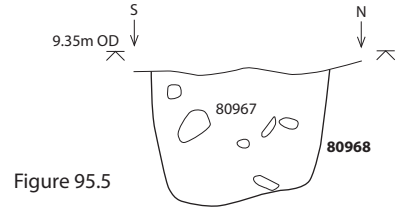
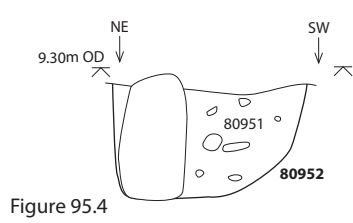
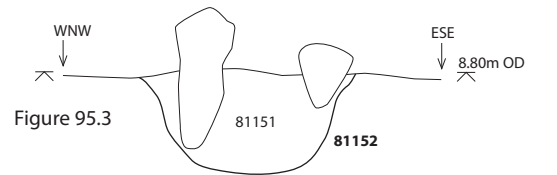
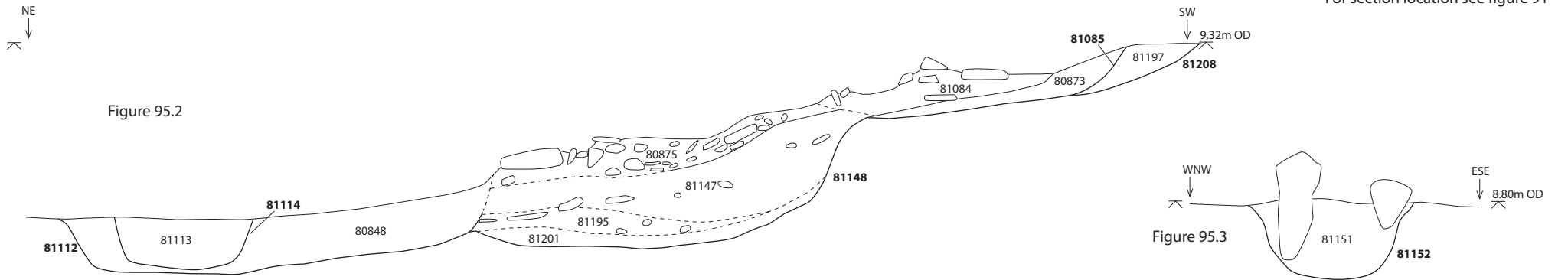

Figure 95. Selected sections of the building complex in Area K9



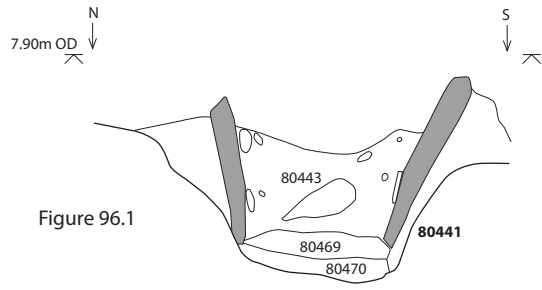

Figure 96.1

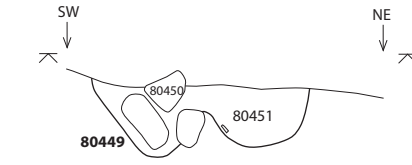

Figure 96.2

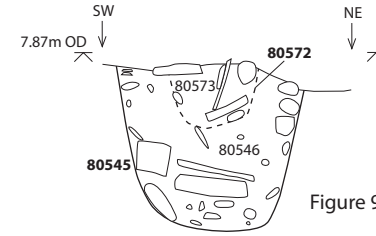

Figure 96.3

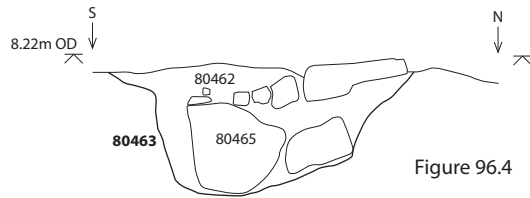
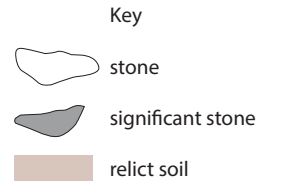

Figure 96.4



For section location see figures 91 and 92

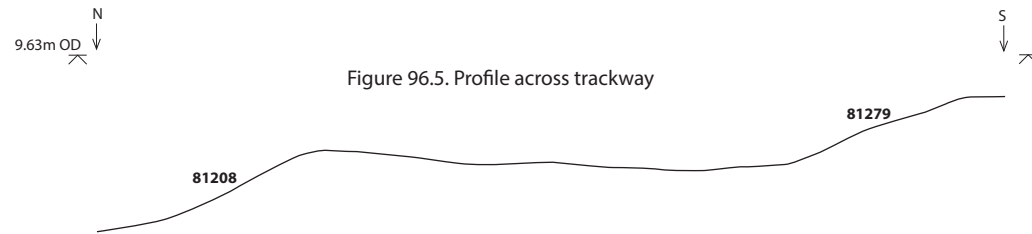

Figure 96.5. Profile across trackway

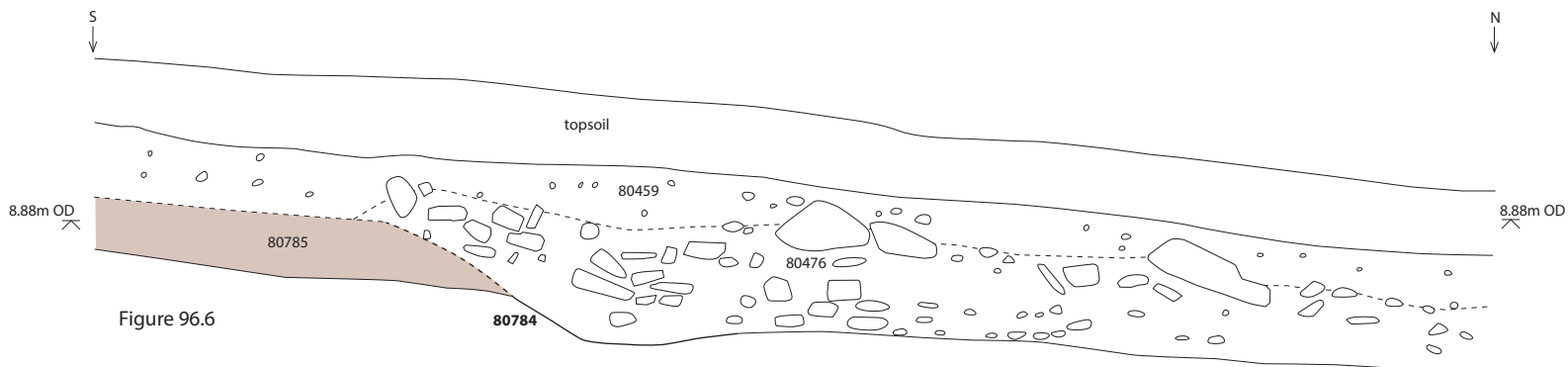
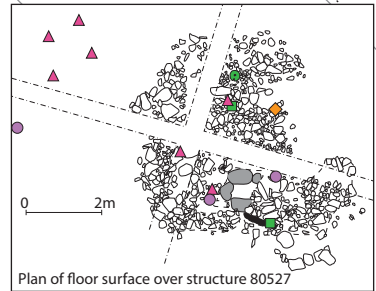
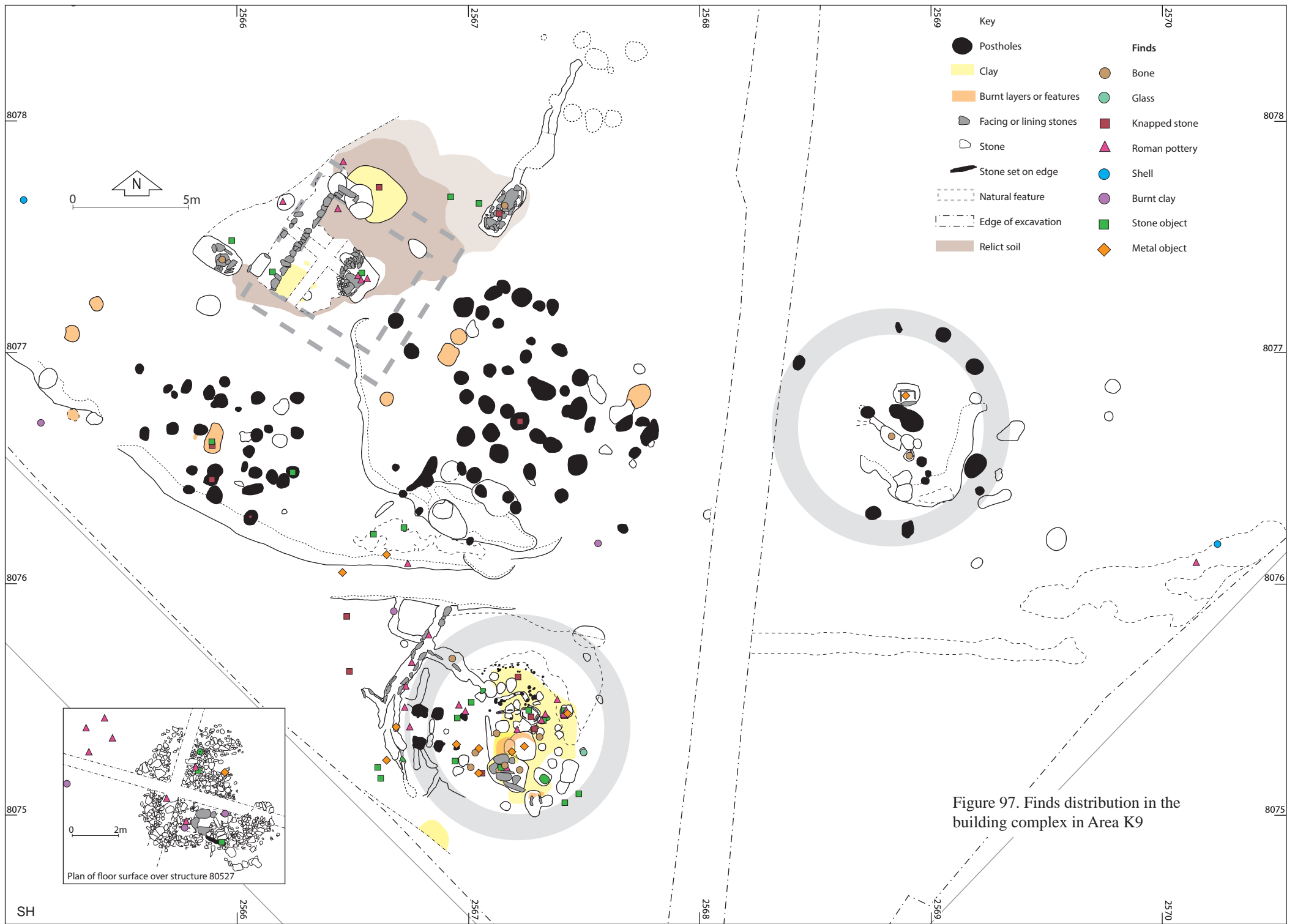

Figure 96.6

Figure 96. Selected sections of the building complex in Area K9



SH

© Crown Copyright and database right 2019. Ordnance Survey 100021874. Welsh Government
 © Hawlfraint a hawliau cronfa ddata'r Goron 2019. Rhif Trwydded yr Arolwg Ordnans 100021874

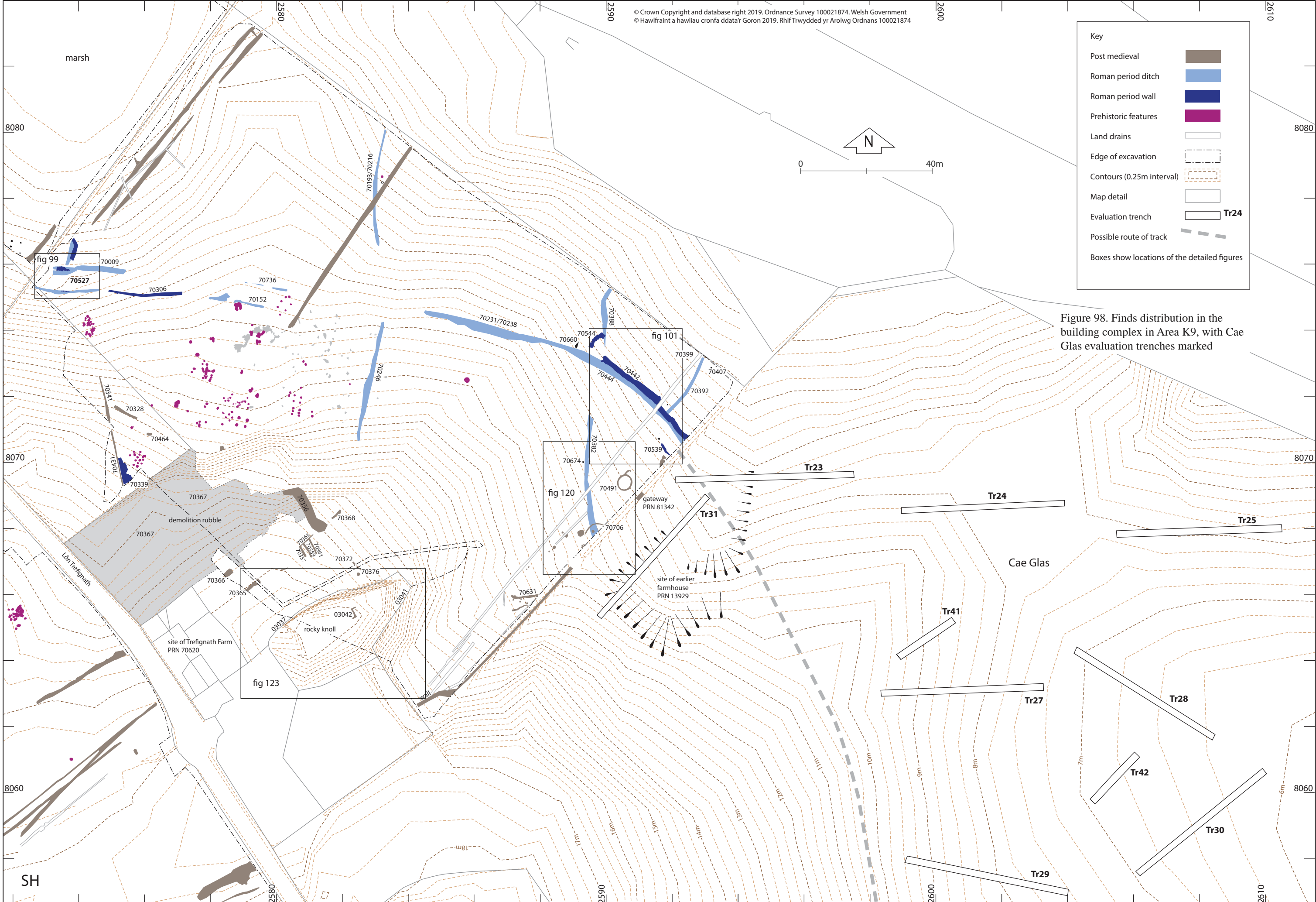

Figure 98. Finds distribution in the building complex in Area K9, with Caer Glas evaluation trenches marked

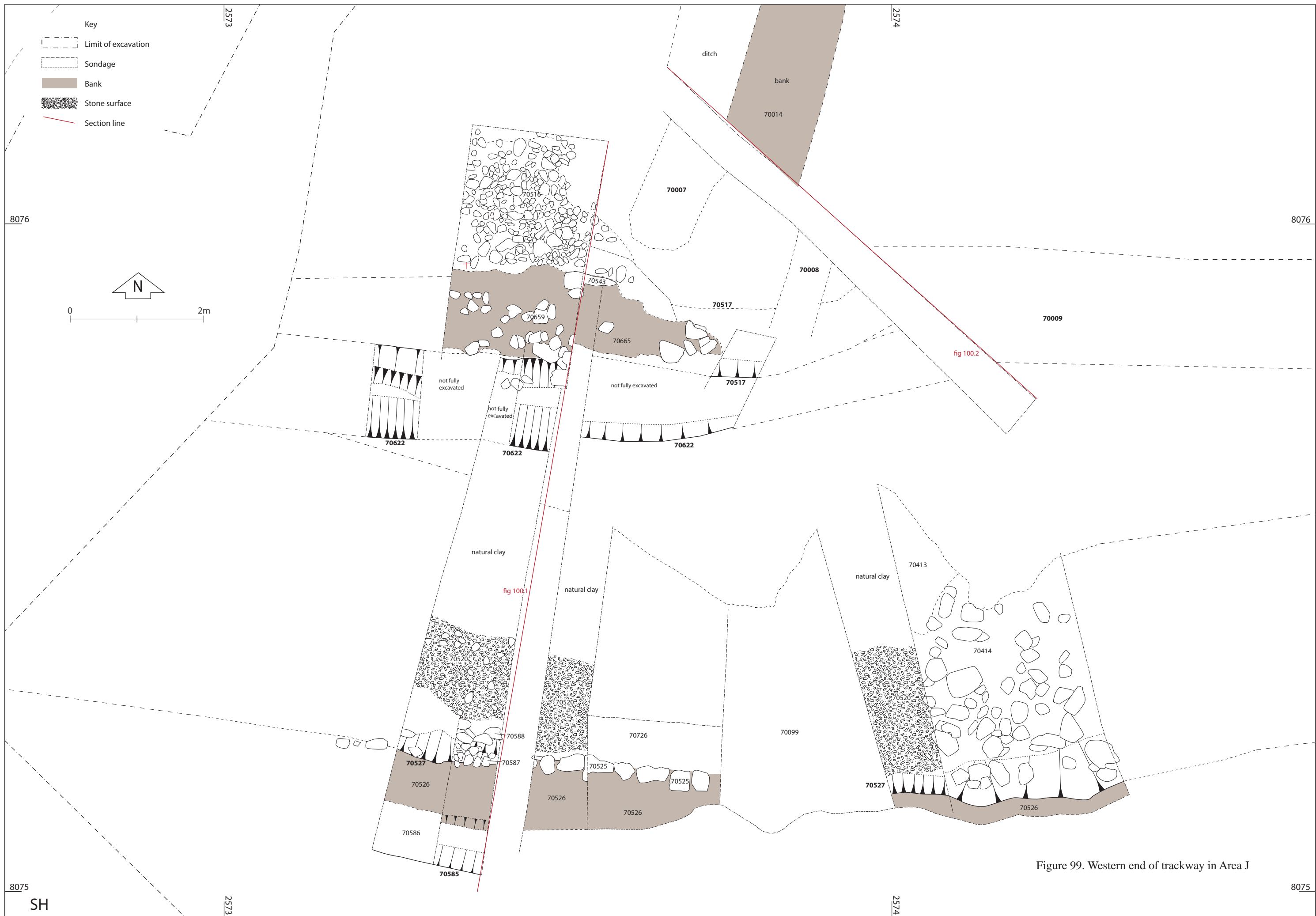

Figure 99. Western end of trackway in Area J

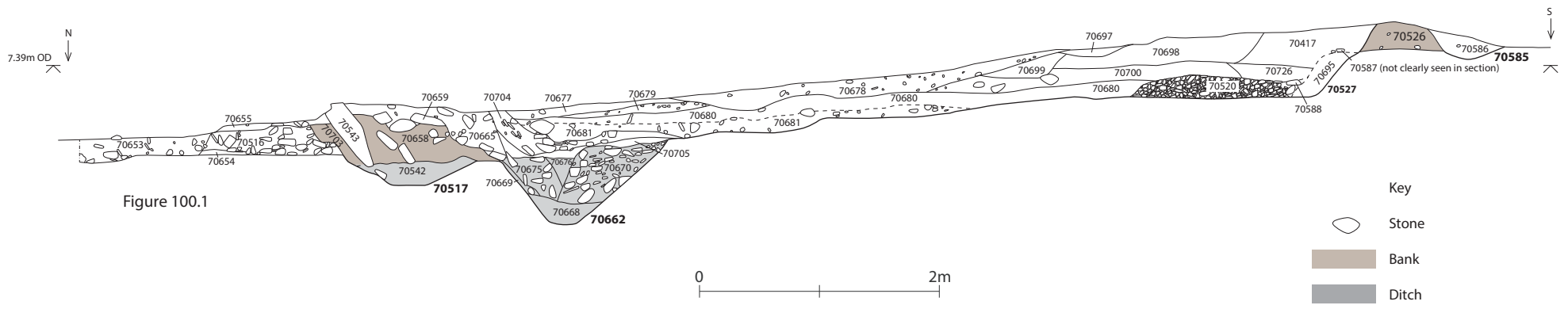

Figure 100.1

Key
 ○ Stone
 ■ Bank
 ■ Ditch
 For section location see figure 99

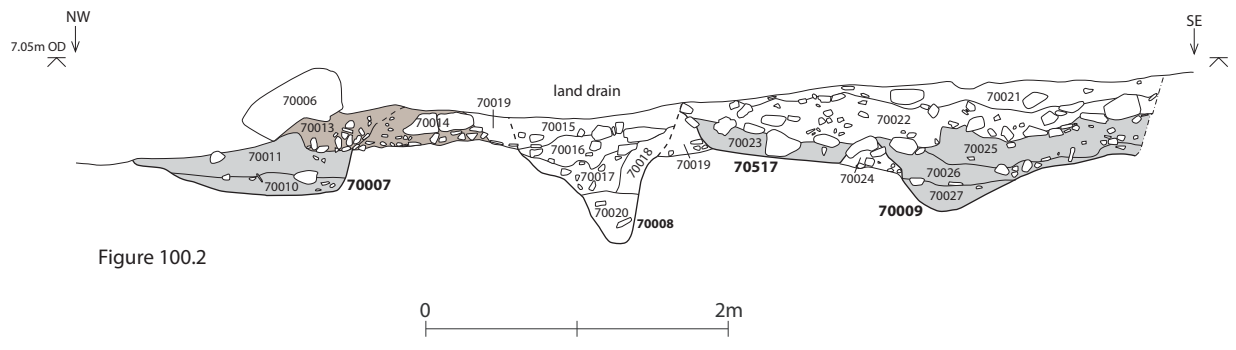

Figure 100.2

Figure 100. Sections of western end of trackway in Area J

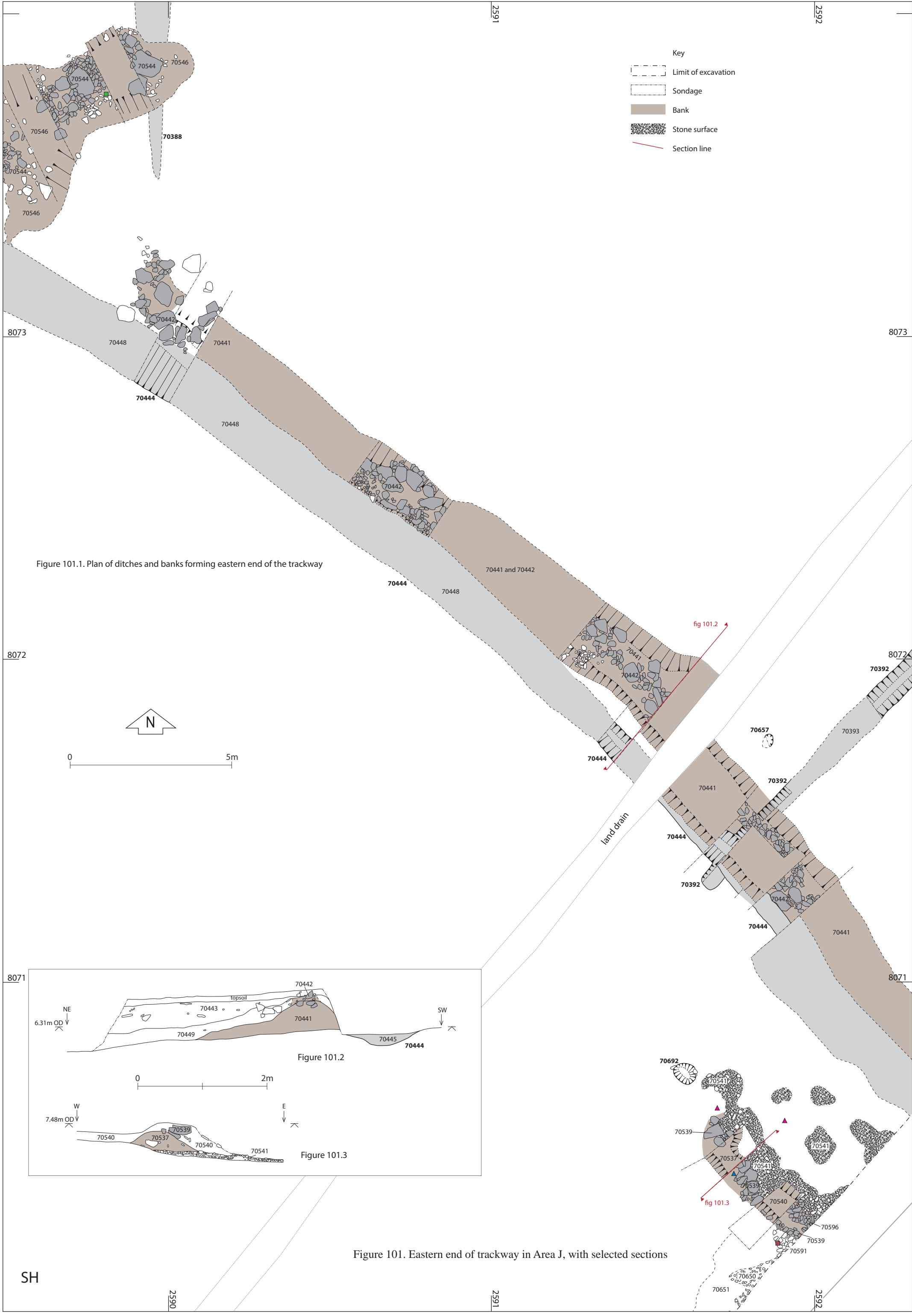

Figure 101.1. Plan of ditches and banks forming eastern end of the trackway

Figure 101.2

Figure 101.3

Figure 101. Eastern end of trackway in Area J, with selected sections



Figure 102. Part of cover sheet for book of Penrhos Estate maps showing route of 18th century tracks and roads (Image courtesy of Archives and Special Collections, Bangor University (Penrhos II, 772, date 1769))

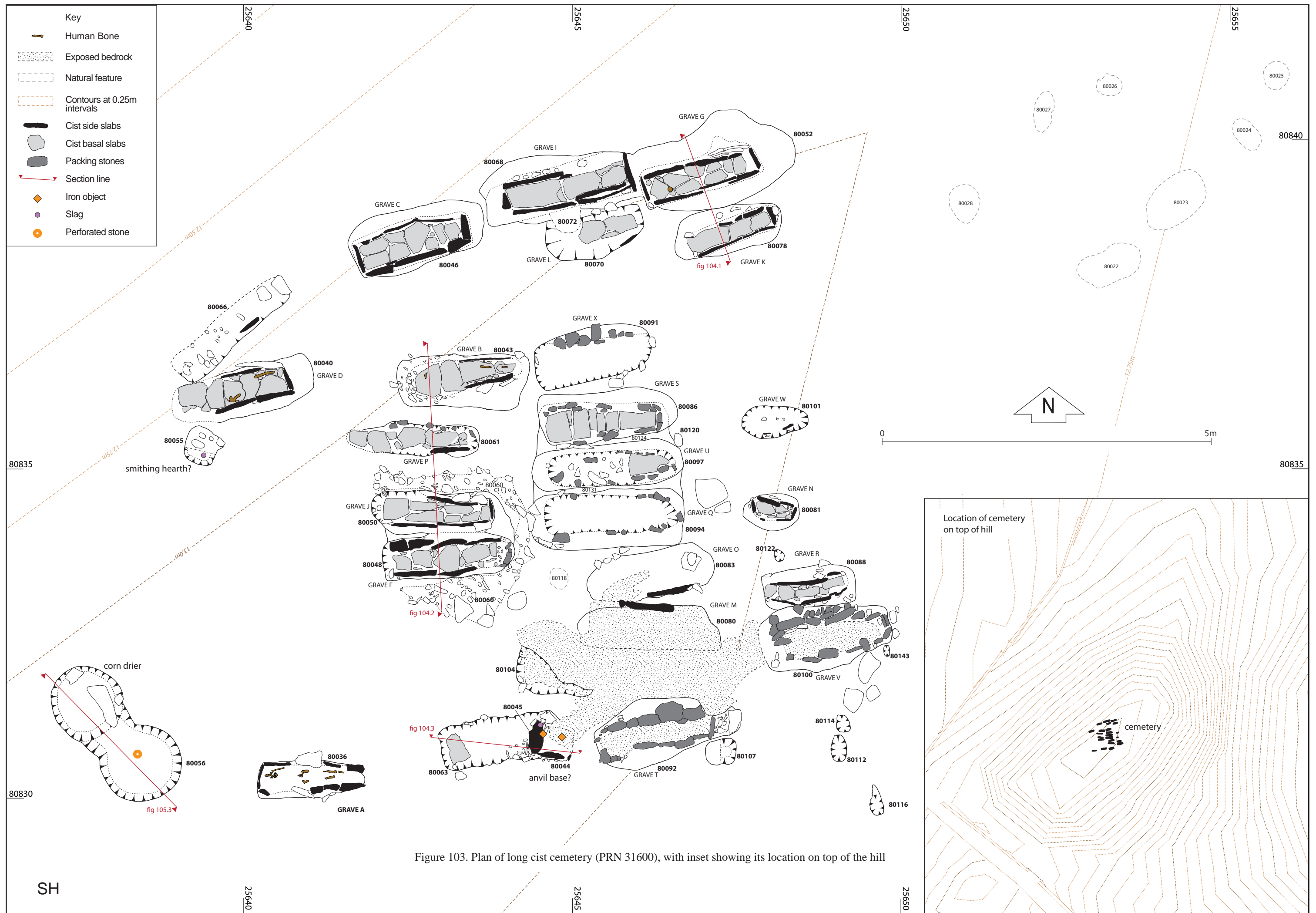

SH

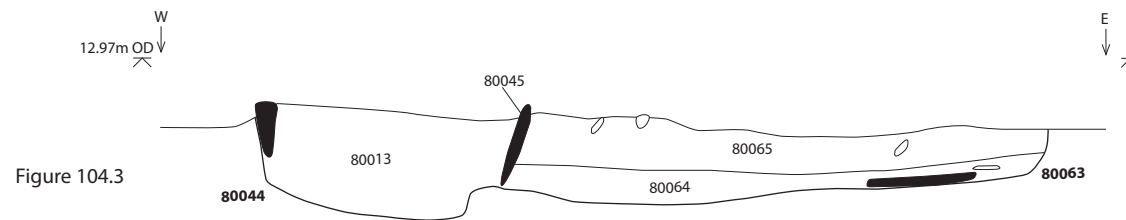
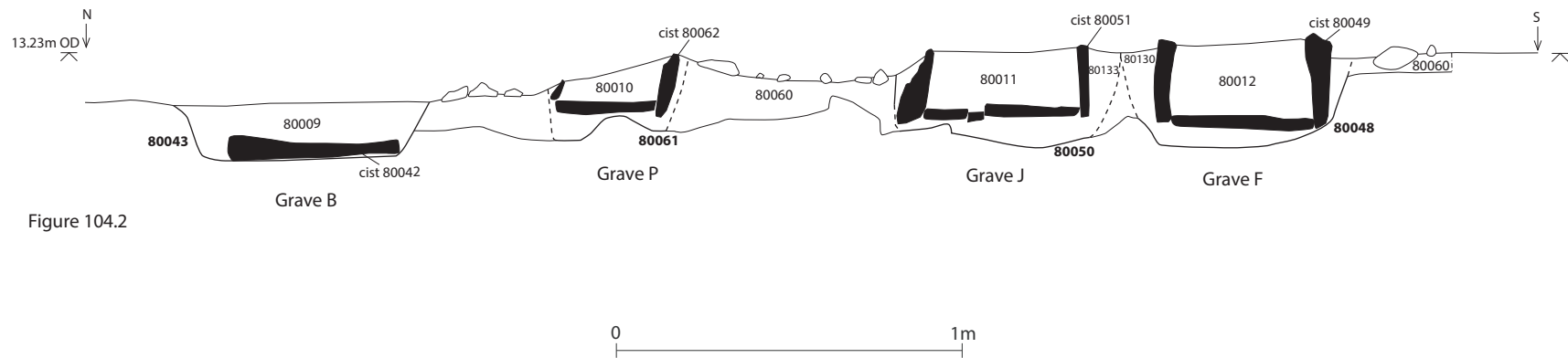
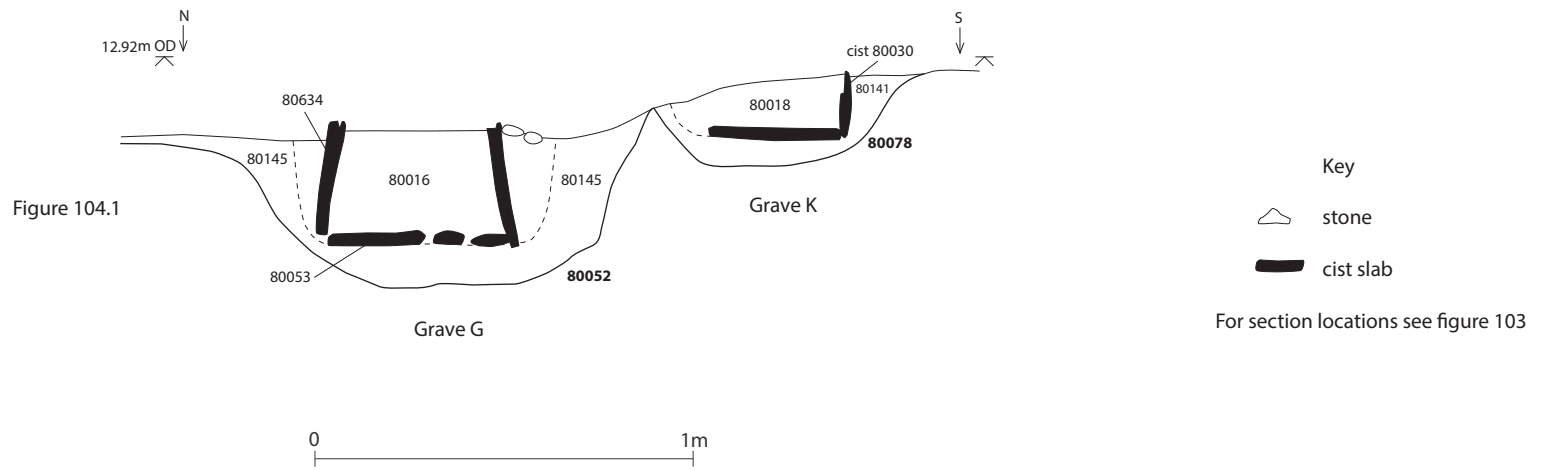

Figure 104. Selected sections from the long cist cemetery

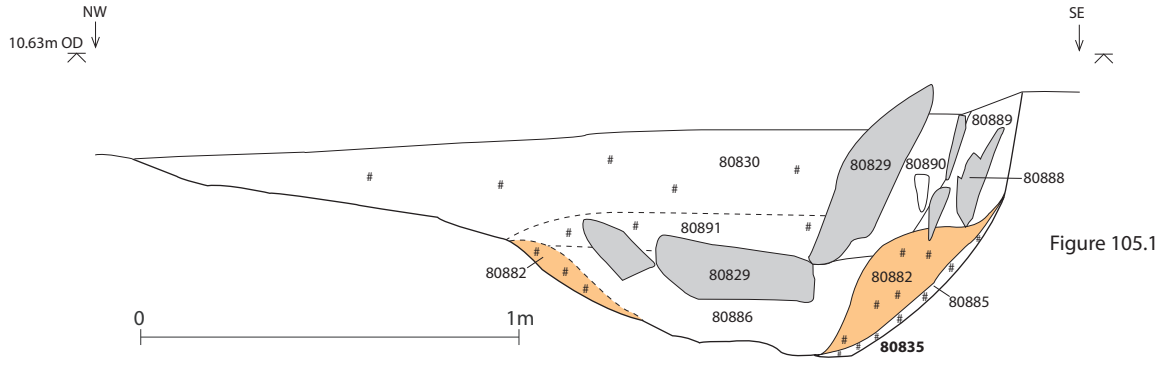

Figure 105.1

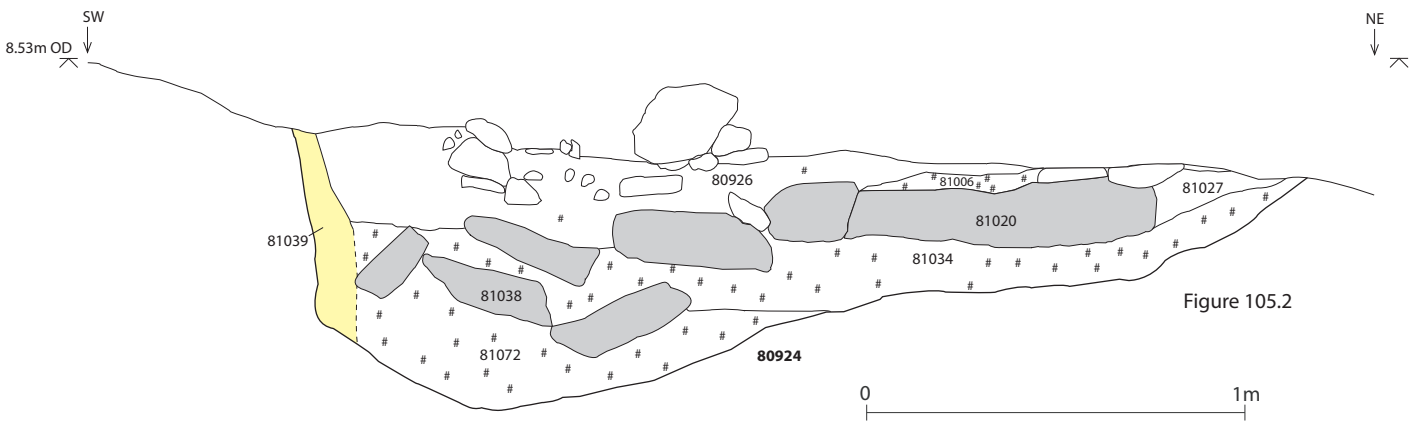

Figure 105.2

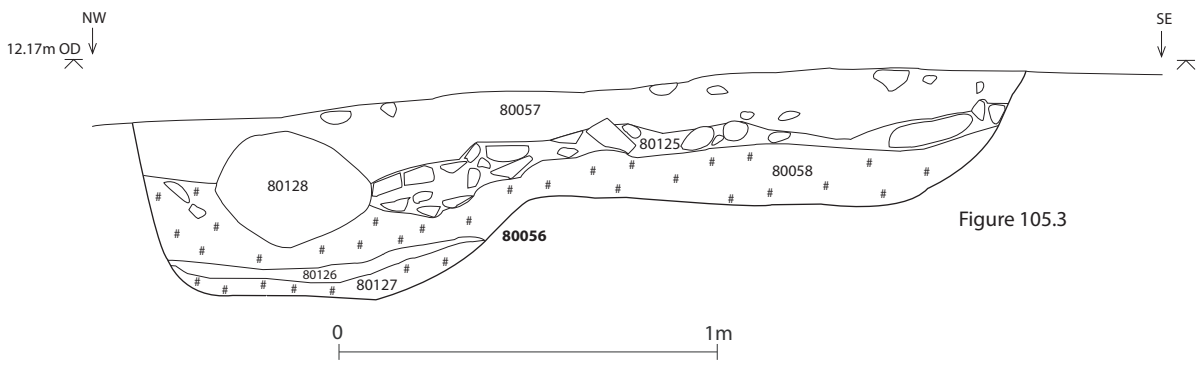

Figure 105.3

Figures 105.1 and 2 located on figure 91, figure 105.3 located on figure 103

- Key
- # # Charcoal
 - Stone
 - Lining stones
 - Clay
 - Burnt clay

Figure 105. Sections of corn dryers

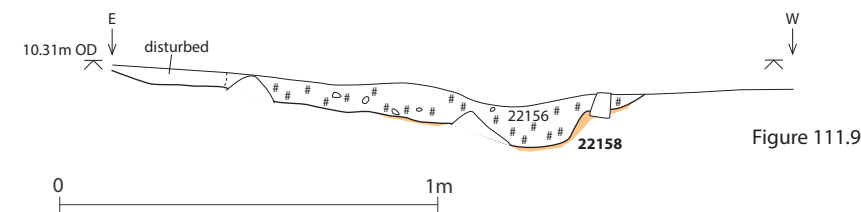
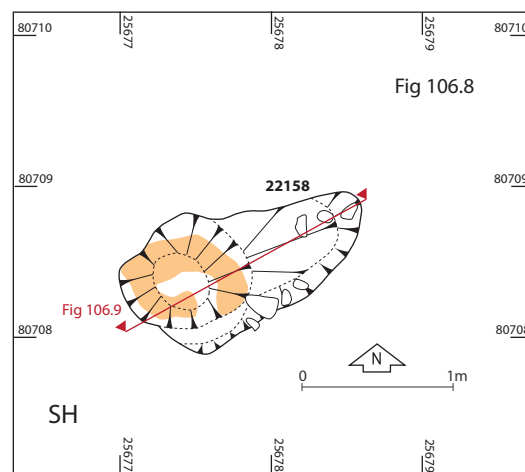
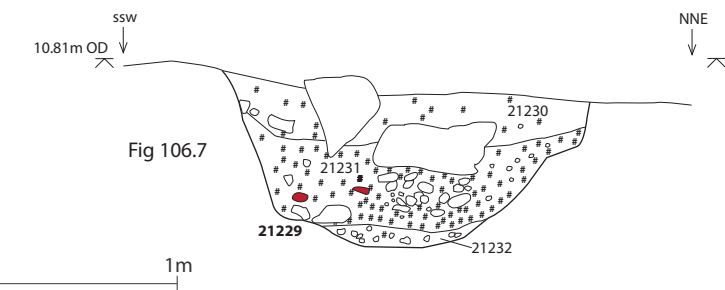
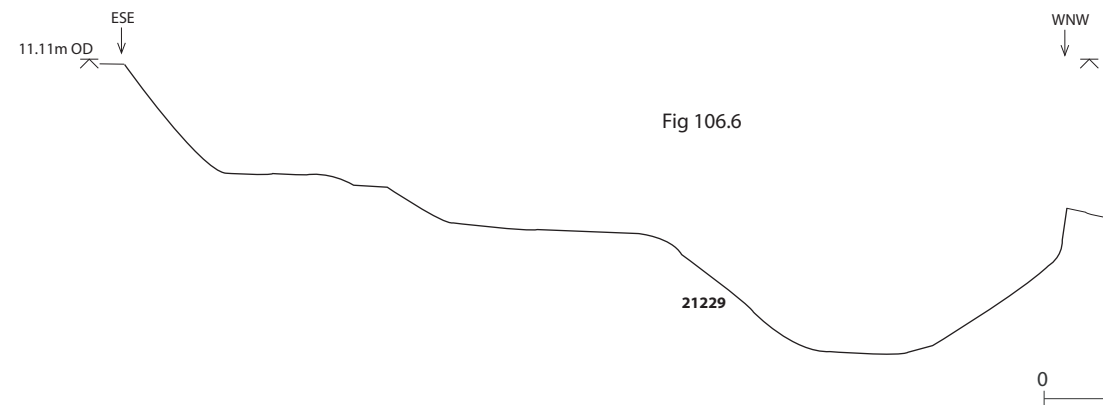
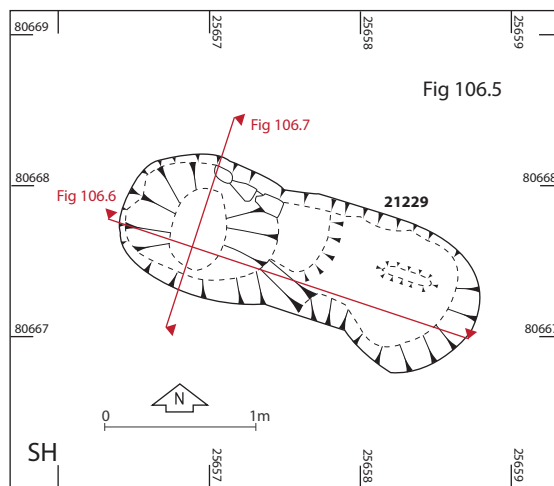
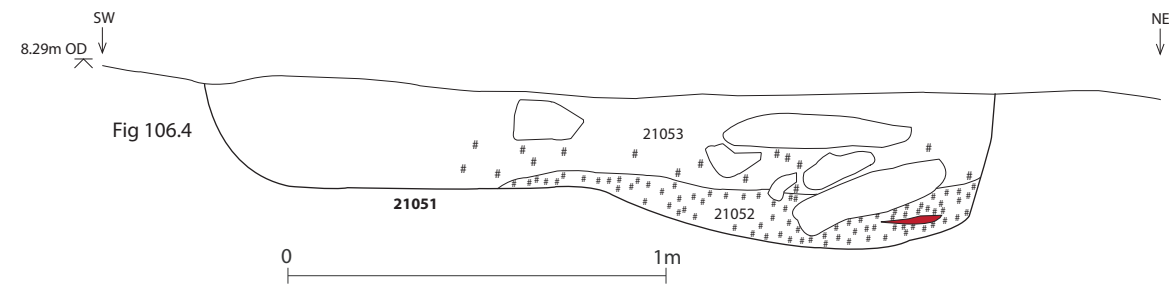
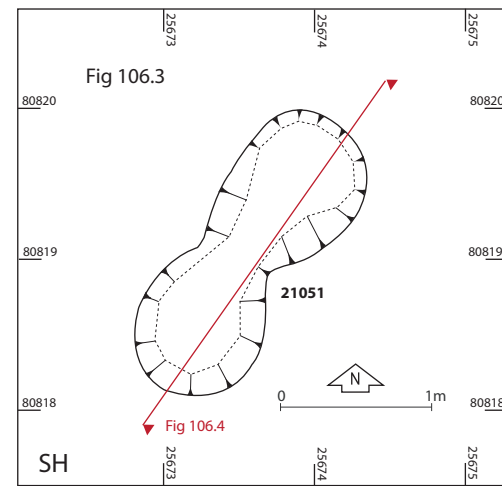
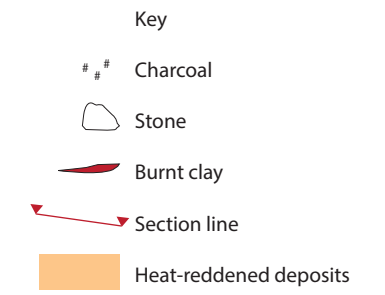
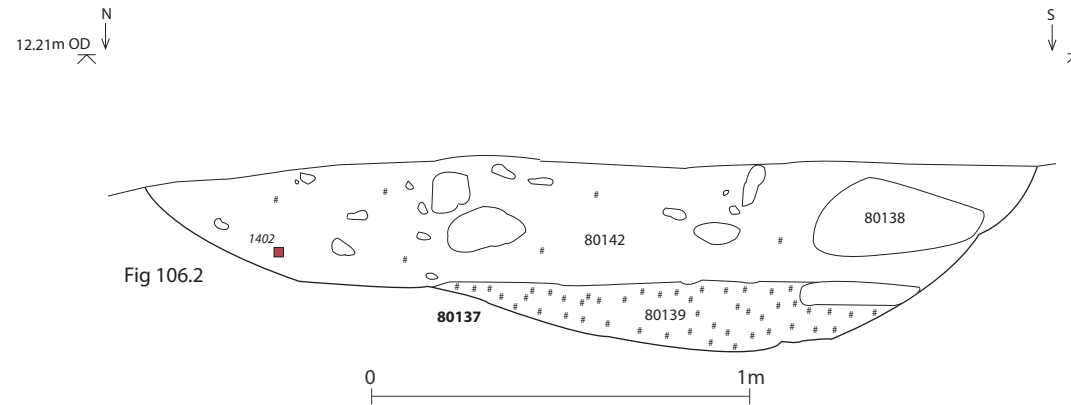
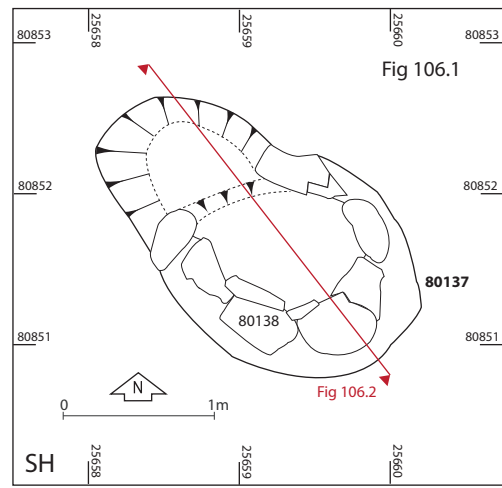

Figure 106. Plans and sections of corn dryers 80137, 21051, 21229 and 22158



Figure 107. Part of a page from Penrhos II 772 showing the farms of Tyddin Piodan (F) and Merddyn Poeth (E) (1769) (Image courtesy of Archives and Special Collections, Bangor University (Penrhos II, 772))

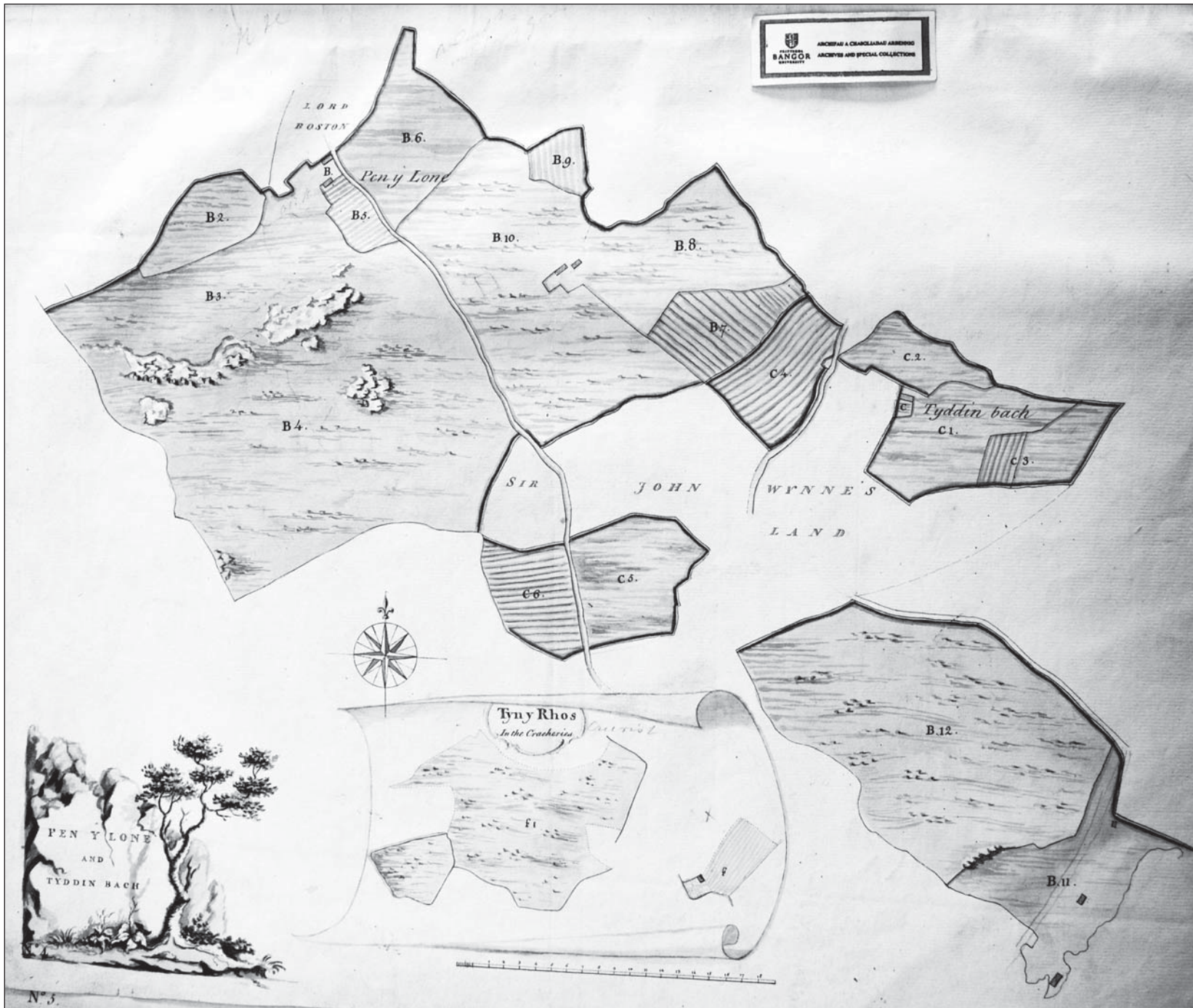

Figure 108. Page from Penrhos II 772 showing the farm of Pen y Lone (1769) (Image courtesy of Archives and Special Collections, Bangor University (Penrhos II, 772))



Figure 109. Page from Penrhos II 804 showing the area of Parc Cybi in 1817
 (Image courtesy of Archives and Special Collections, Bangor University (Penrhos II, 804))

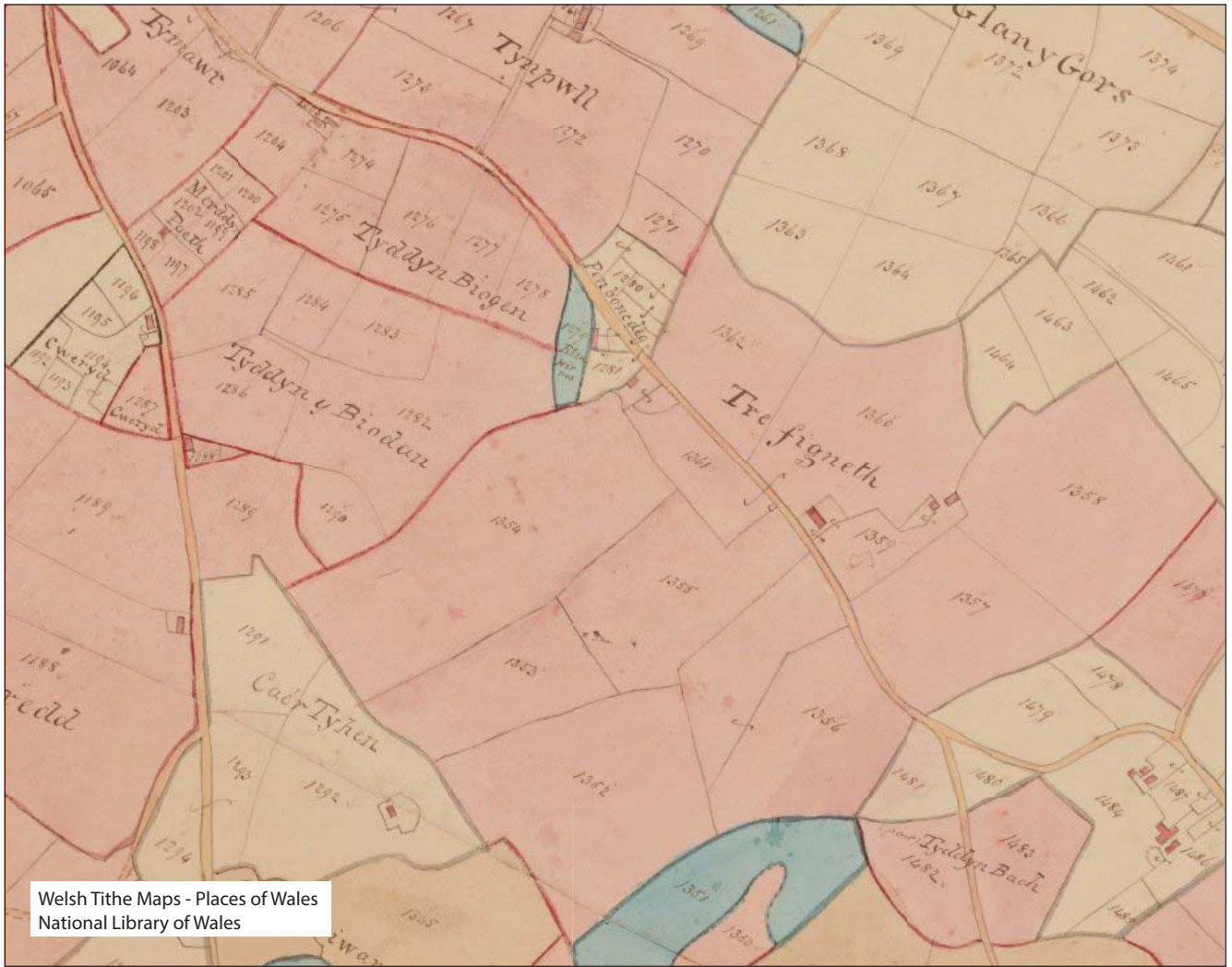
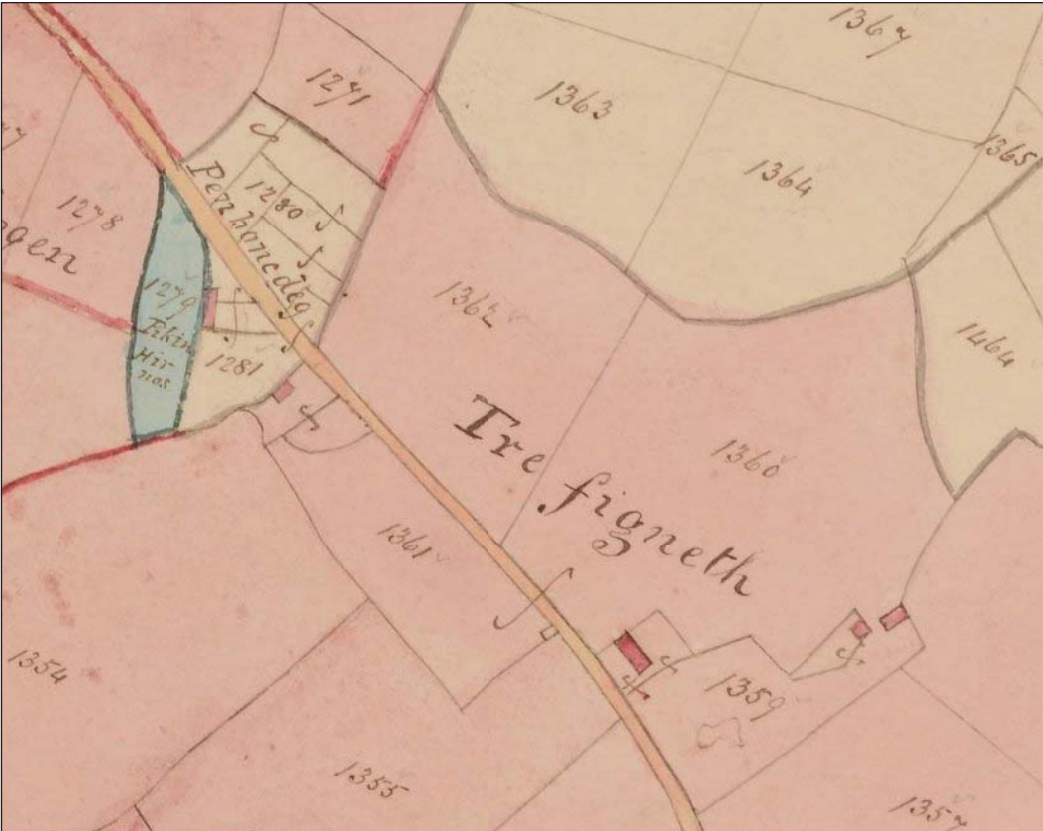

Figure 110. Part of the tithe map for the Parish of Holyhead in the County of Anglesey (1841)



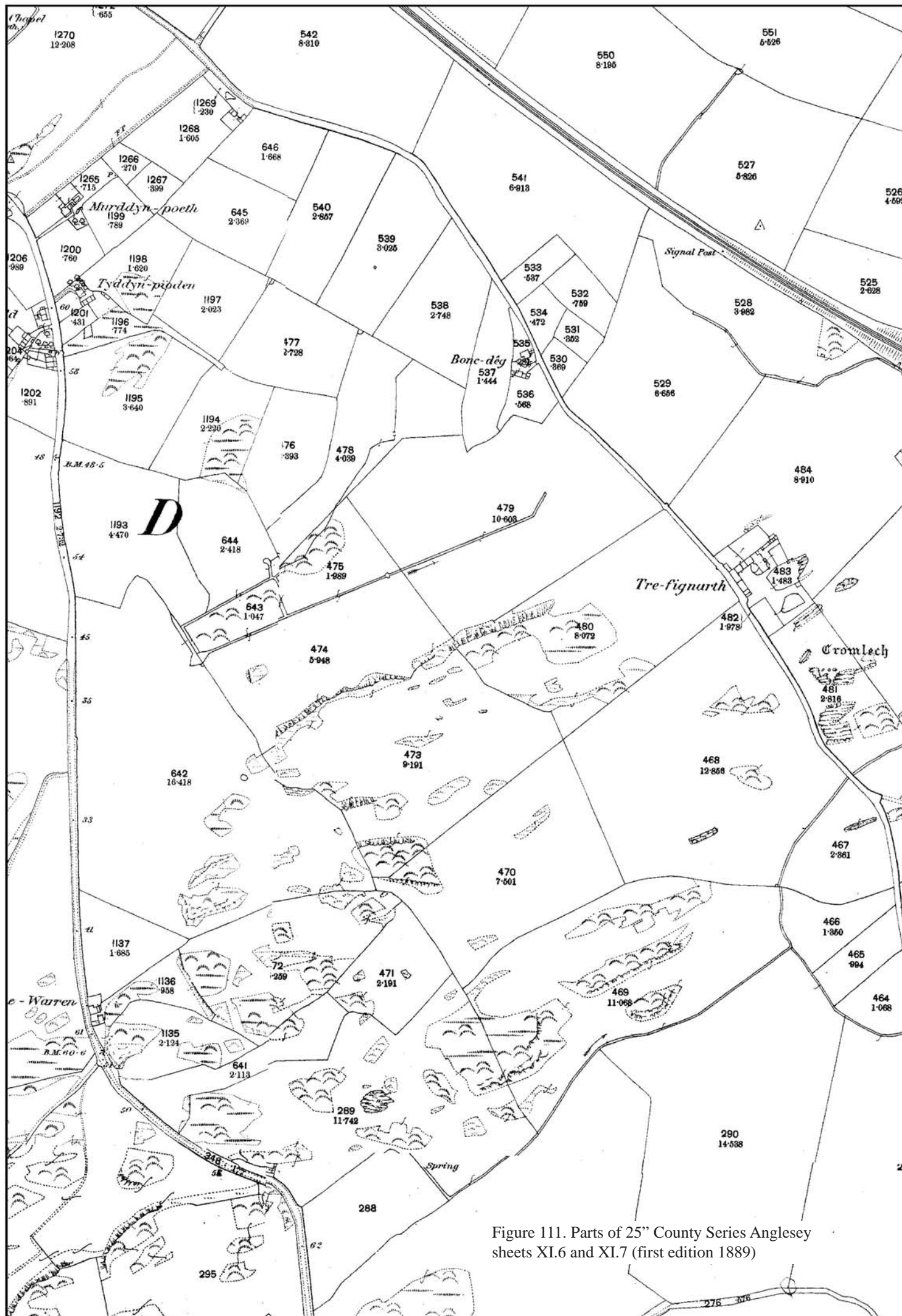

Figure 111. Parts of 25" County Series Anglesey sheets XI.6 and XI.7 (first edition 1889)

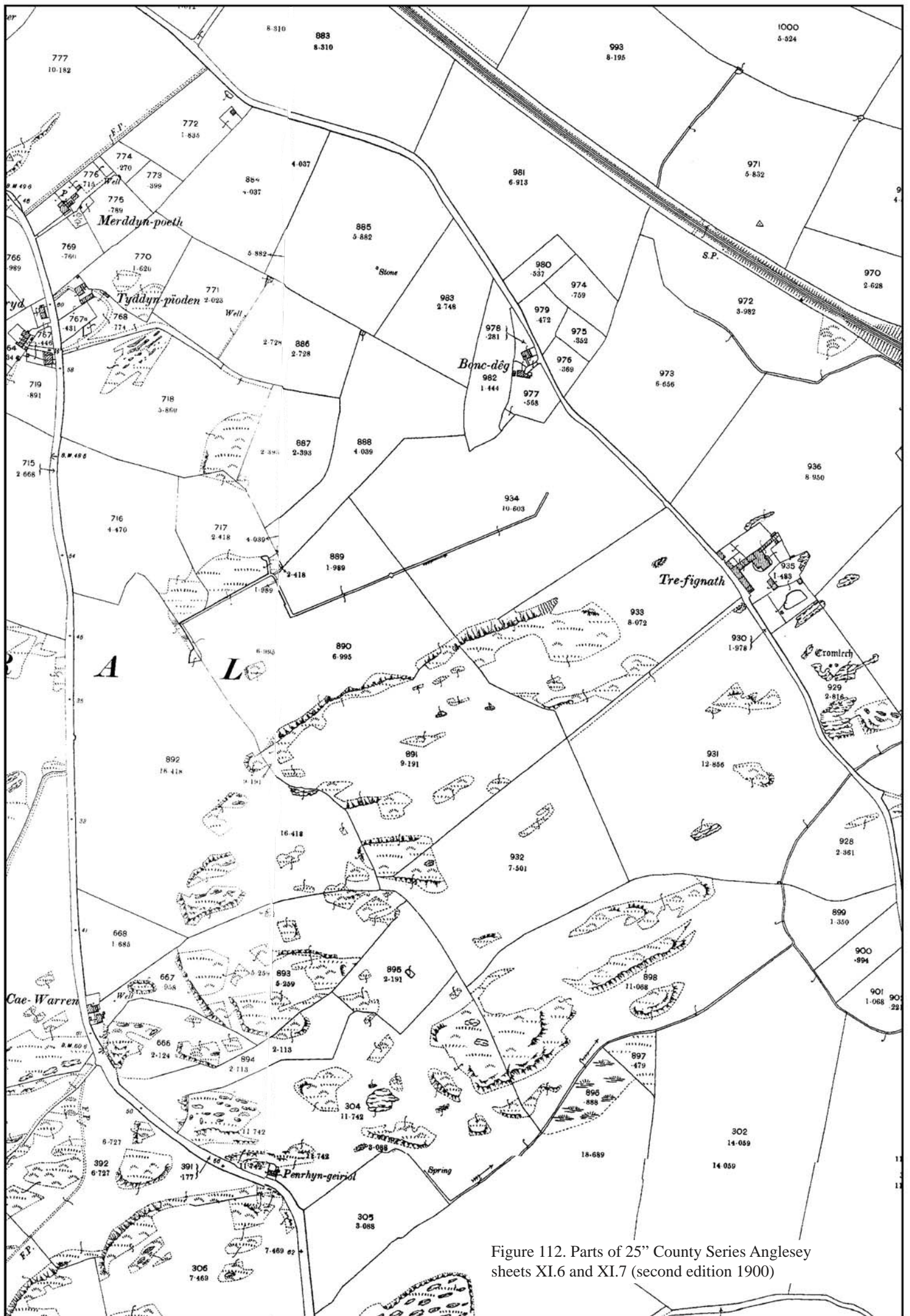

Figure 112. Parts of 25" County Series Anglesey sheets XI.6 and XI.7 (second edition 1900)

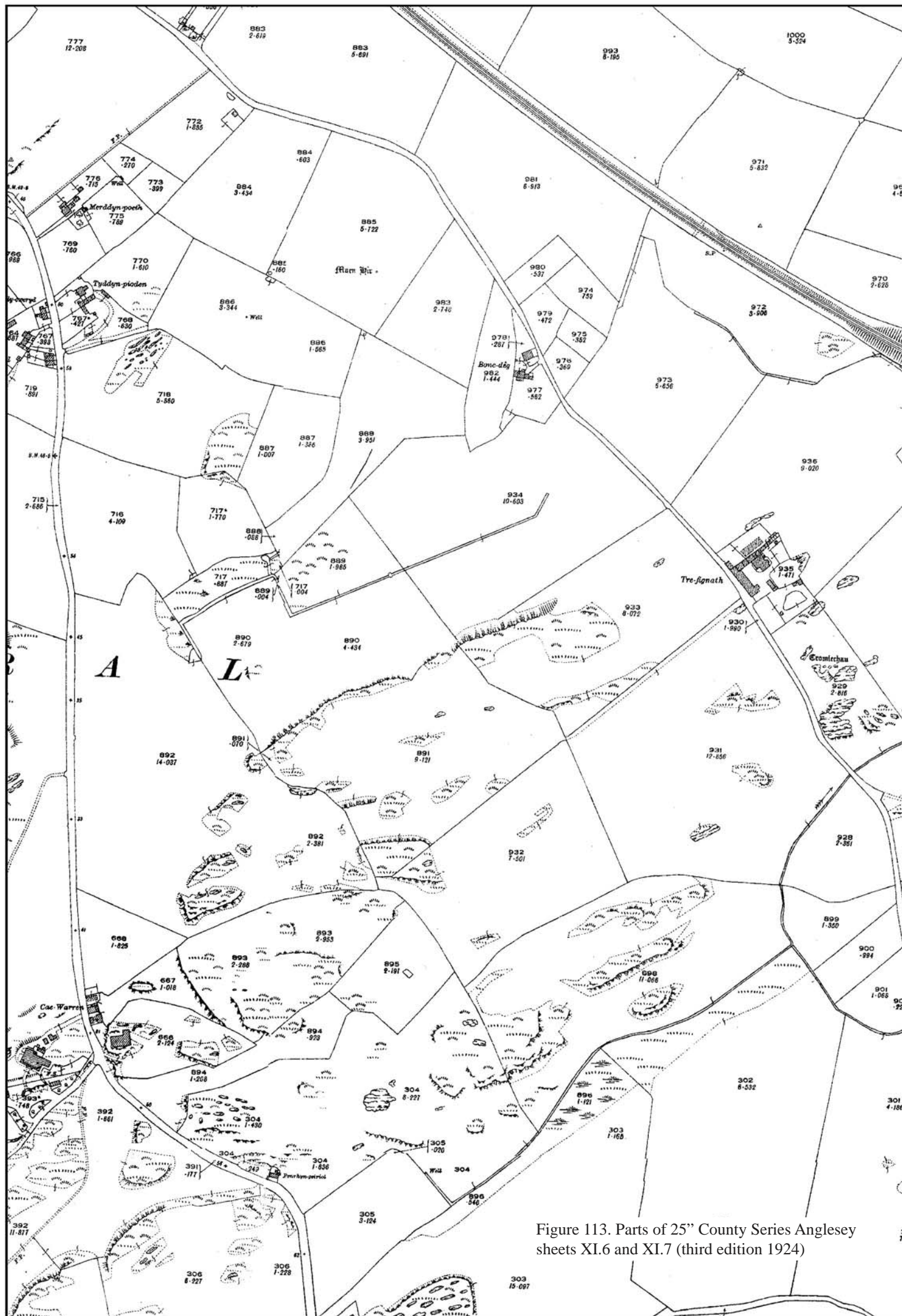
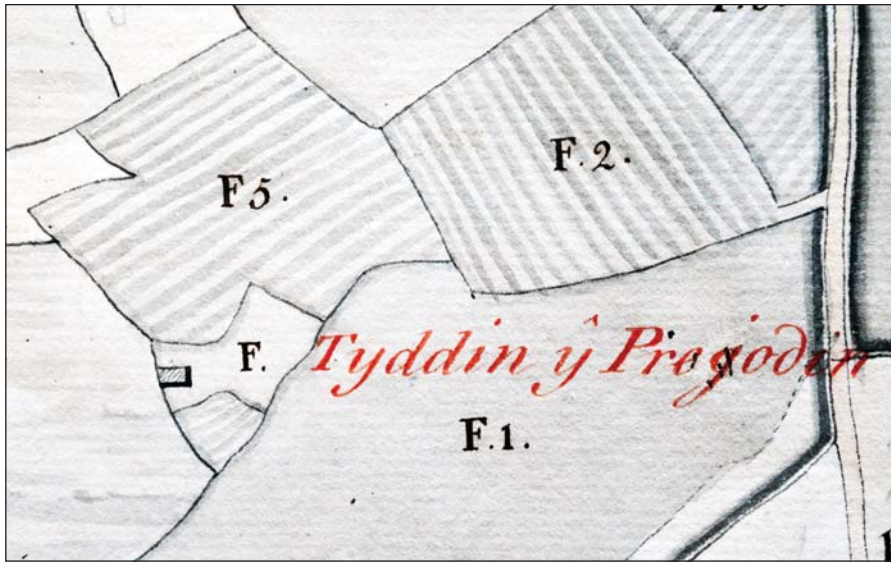
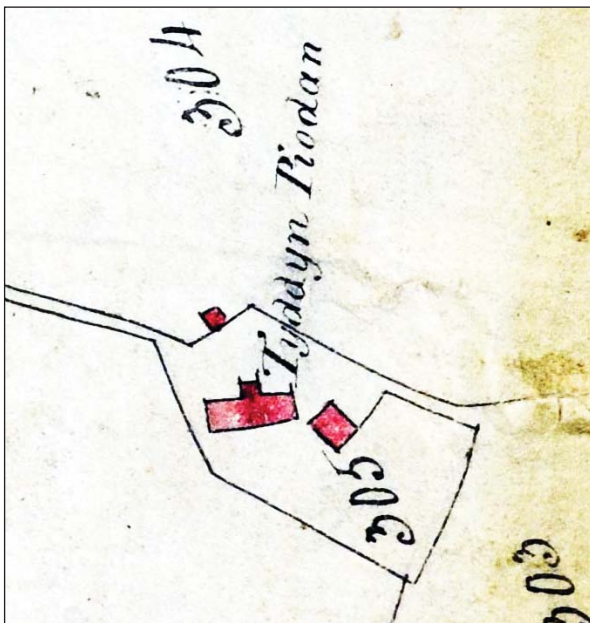

Figure 113. Parts of 25" County Series Anglesey sheets XI.6 and XI.7 (third edition 1924)



Tyddyn Pioden on Penrhos II 772 (1769), (Bangor University Archives)



Tyddyn Pioden on Penrhos II 778 (left) and 804 (right) (1817) (Images courtesy of Archives and Special Collections, Bangor University)

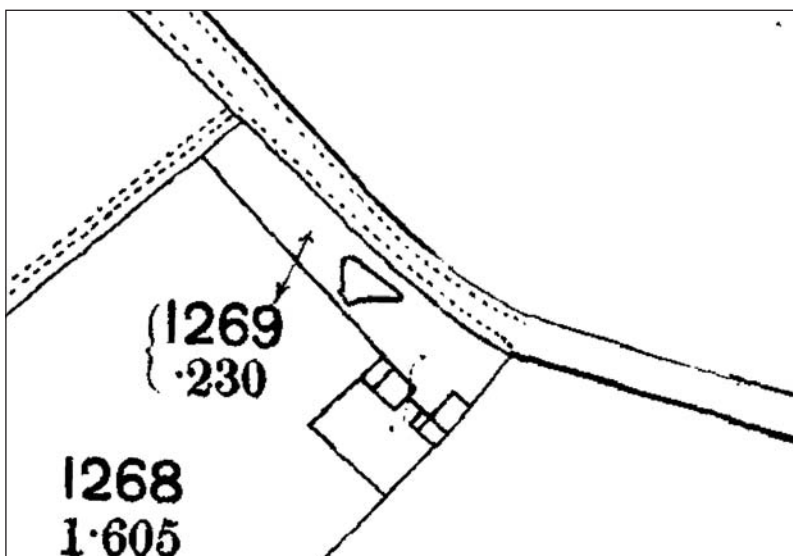

Figure 114. Tyddyn Pioden farm on maps of various dates (PRN 18403)

The house associated with Tyddyn Biogen on 25 inch OS map (first edition 1889)

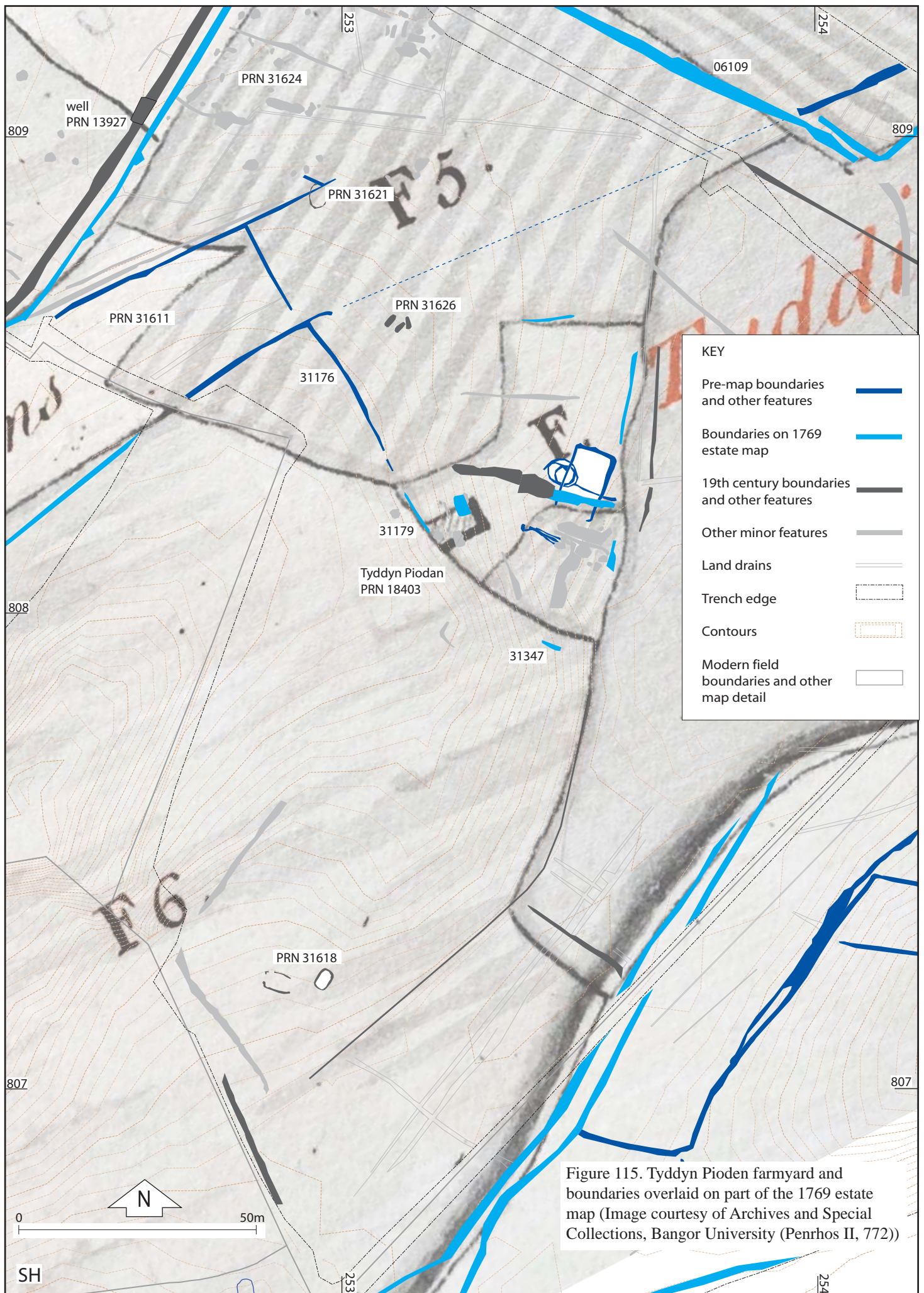

Figure 115. Tyddyn Pioden farmyard and boundaries overlaid on part of the 1769 estate map (Image courtesy of Archives and Special Collections, Bangor University (Penrhos II, 772))

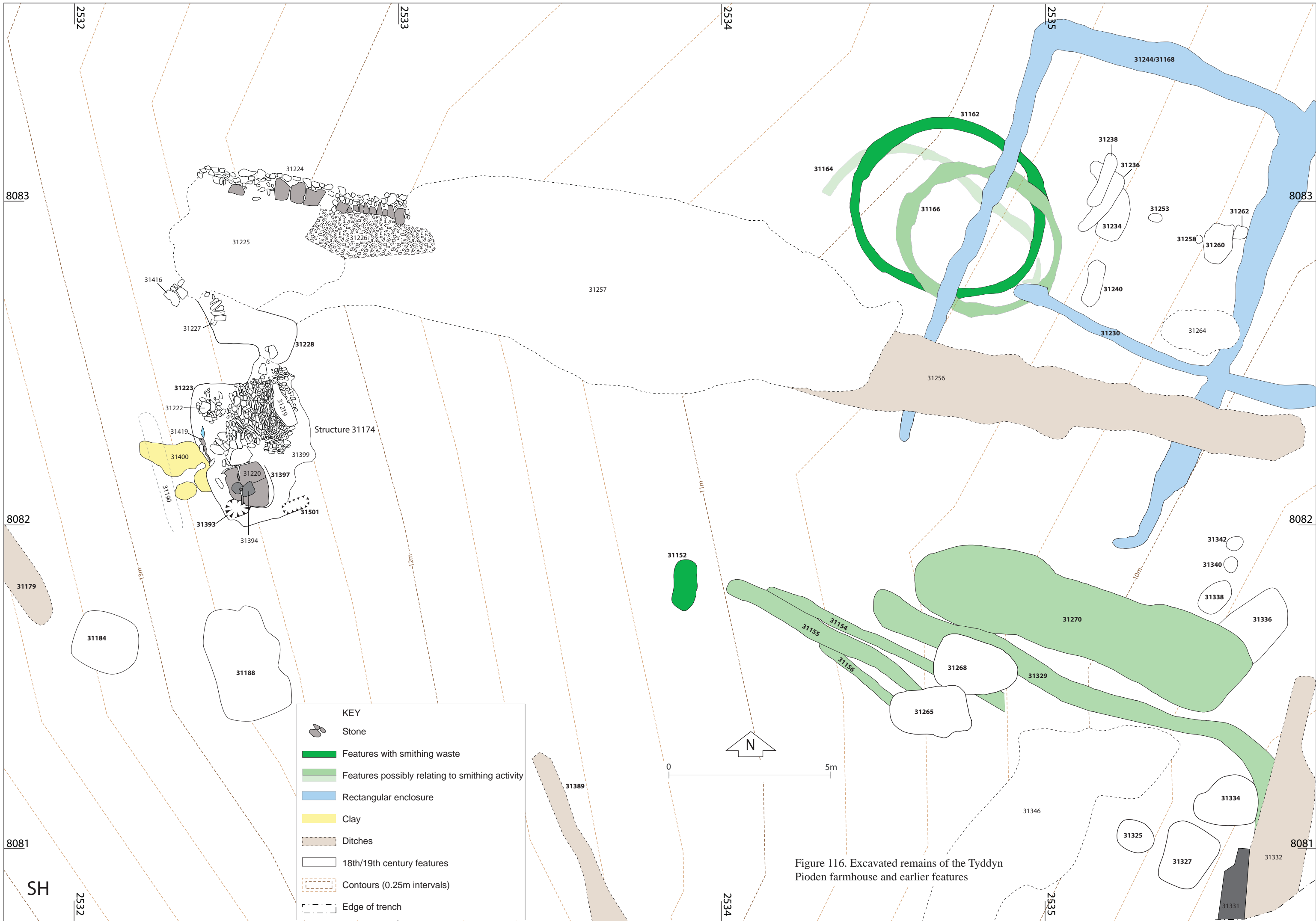
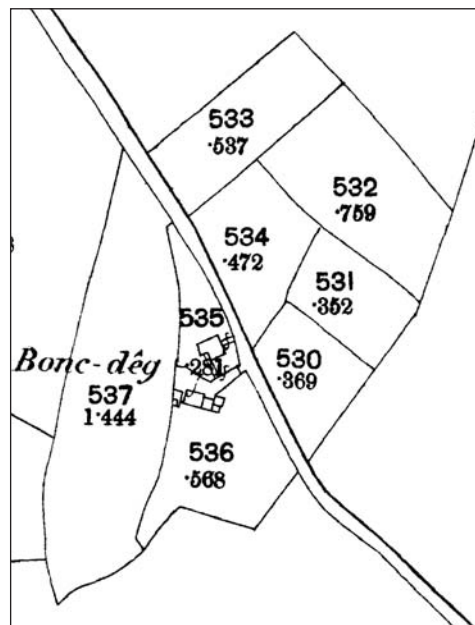
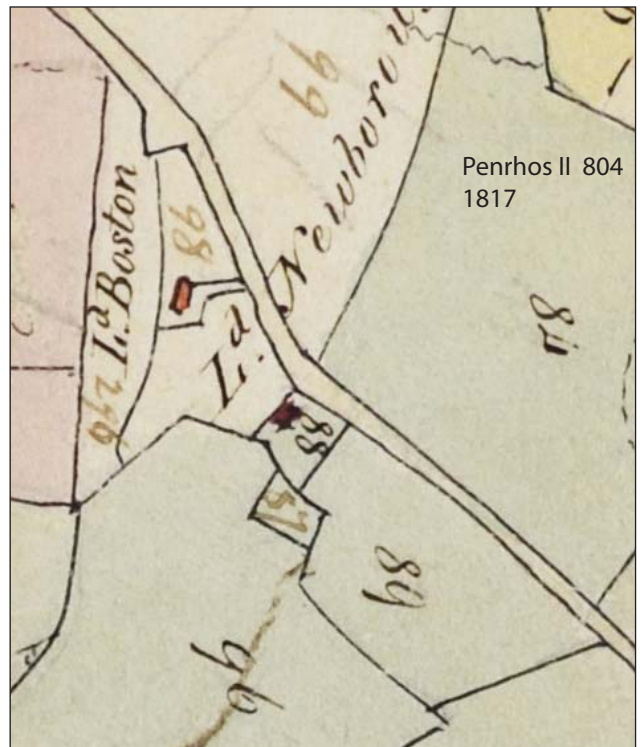
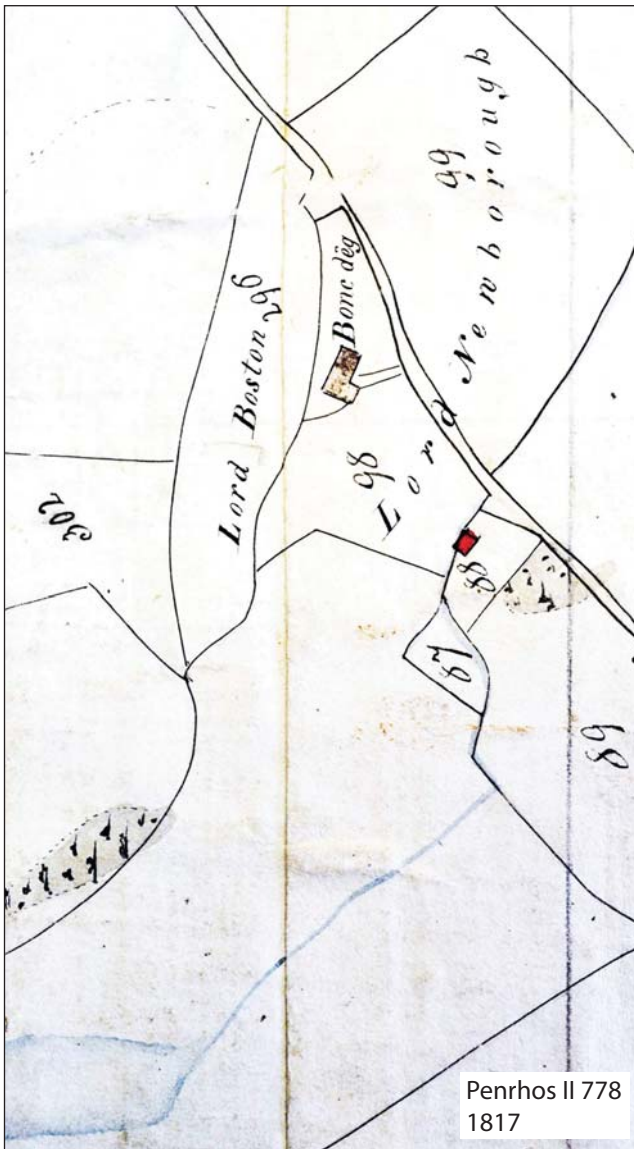
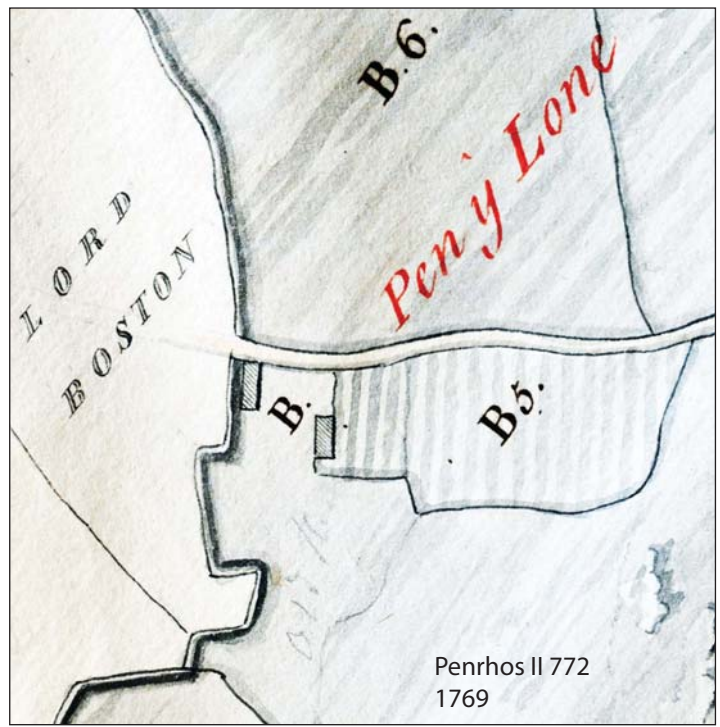
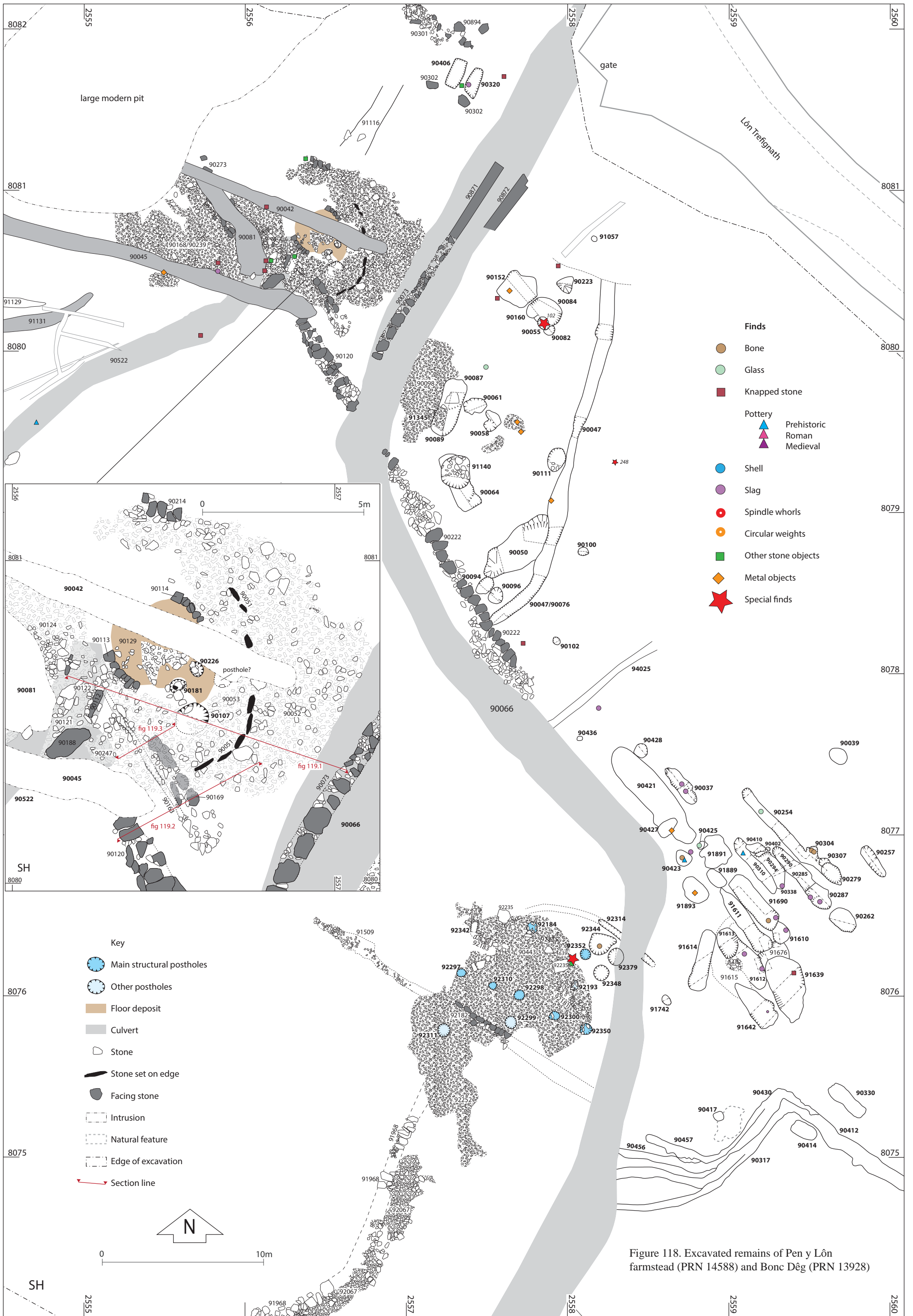

Figure 116. Excavated remains of the Tyddyn Pioden farmhouse and earlier features



25" OS Map
First edition 1889

Figure 117. Details of maps showing Pen y Lôn and Bonc Dêg (Penrhos II Estate Maps, images courtesy of Archives and Special Collections, Bangor University)



- Finds**
- Bone
 - Glass
 - Knapped stone
 - Pottery**
 - ▲ Prehistoric
 - ▲ Roman
 - ▲ Medieval
 - Shell
 - Slag
 - Spindle whorls
 - Circular weights
 - Other stone objects
 - ◆ Metal objects
 - ★ Special finds

- Key**
- Main structural postholes
 - Other postholes
 - Floor deposit
 - Culvert
 - Stone
 - Stone set on edge
 - Facing stone
 - Intrusion
 - Natural feature
 - Edge of excavation
 - Section line

Figure 118. Excavated remains of Pen y Lôn farmstead (PRN 14588) and Bonc Dêg (PRN 13928)

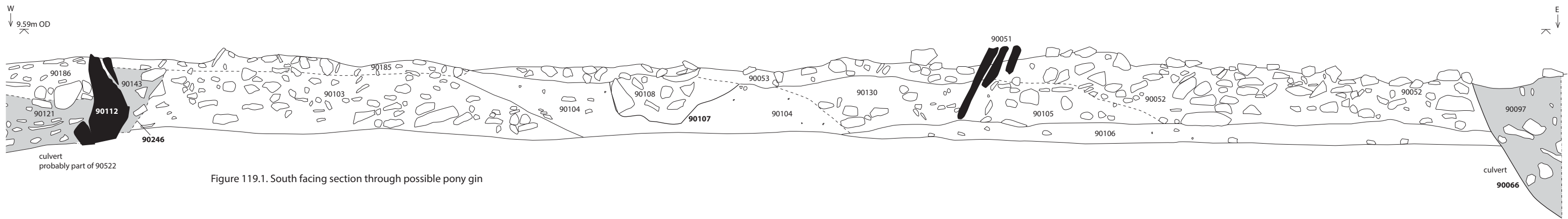





Figure 119.1. South facing section through possible pony gin



- Key
-  stone
 -  stone on edge
 -  culvert
 -  wall stones

For section location see figure 121

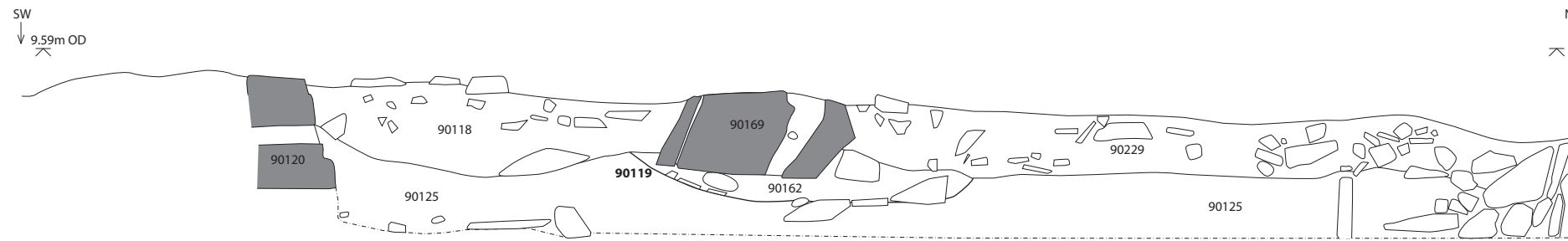

Figure 119.2. South-east facing section through wall 90169

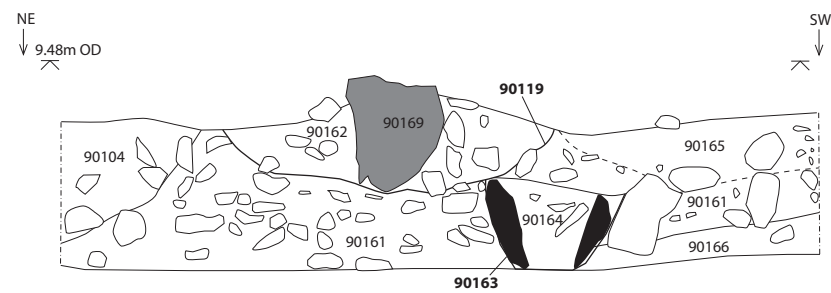
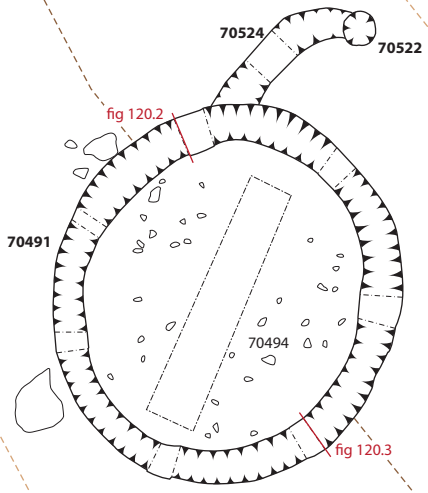
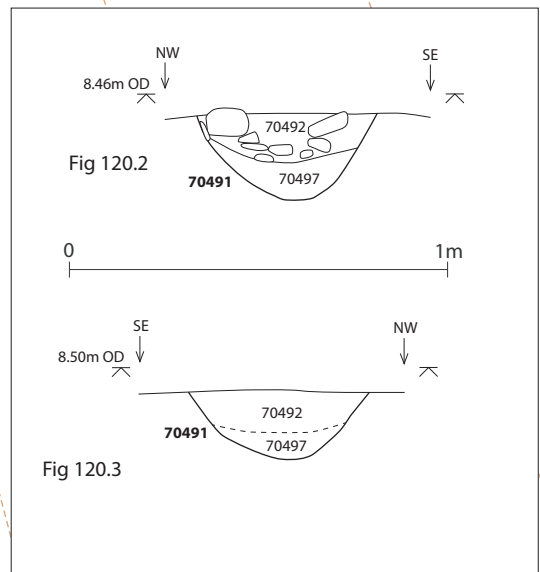
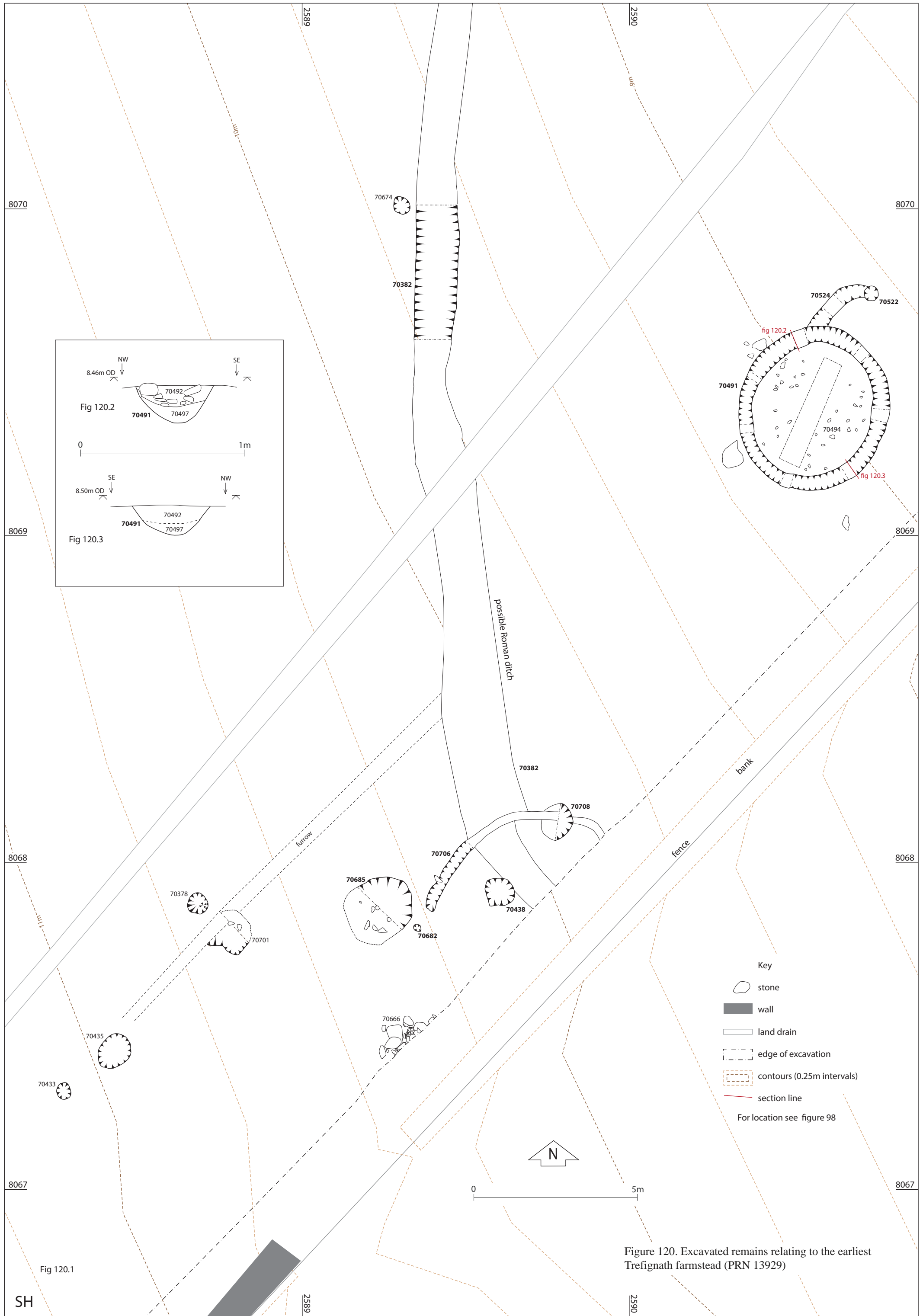

Figure 119.3. North-west facing section through wall 90169 and drain 90163

Figure 119. Sections through possible pony gin and related features next to the Pen y Lôn farmstead (PRN 14588)



- Key
- stone
 - wall
 - land drain
 - edge of excavation
 - contours (0.25m intervals)
 - section line
- For location see figure 98

Figure 120. Excavated remains relating to the earliest Trefignath farmstead (PRN 13929)

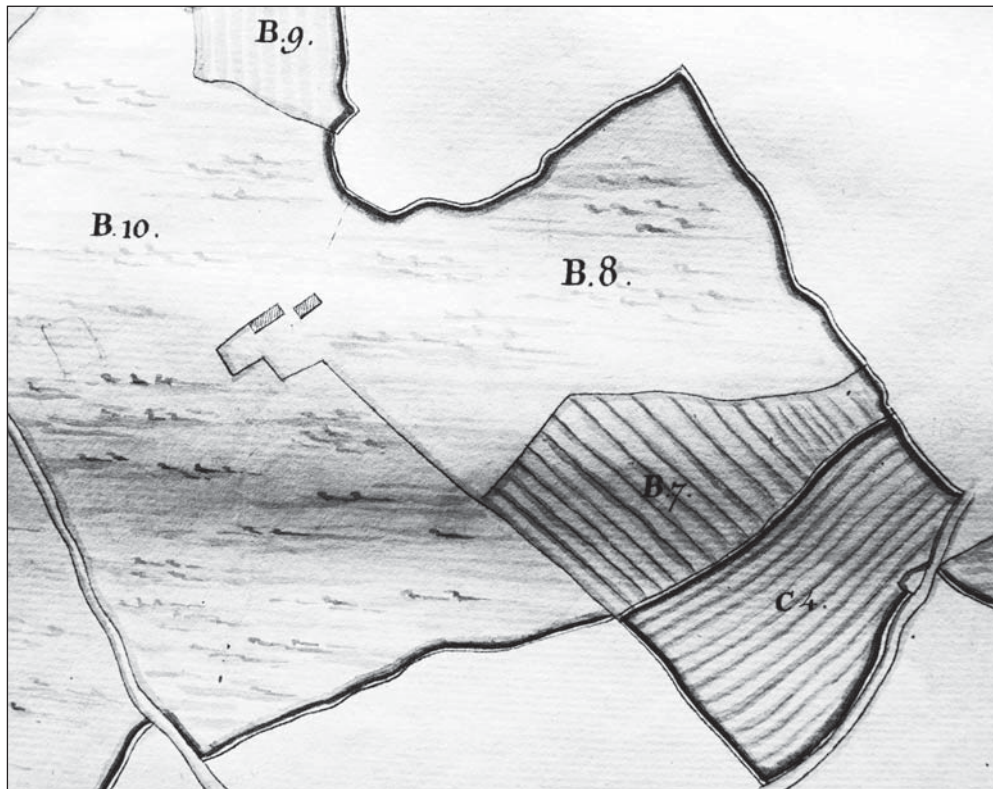

Trefignath on Penrhos II 772 (1769)

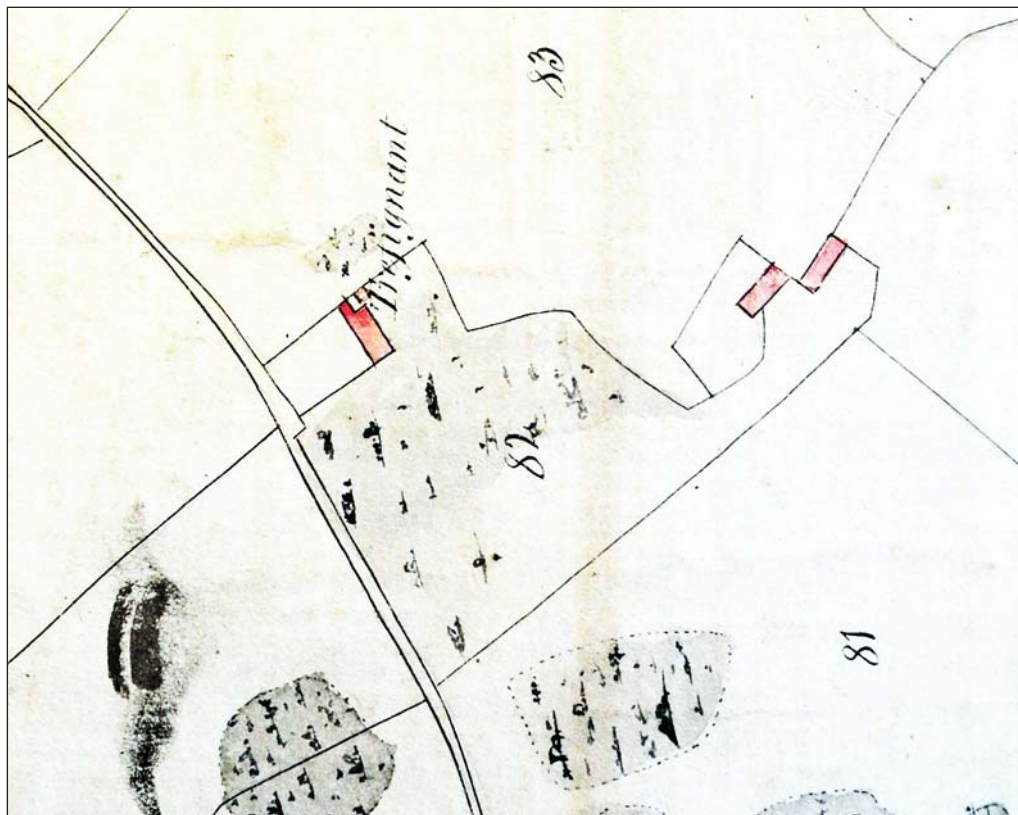

Trefignath on Penrhos II 778 (1817)

Figure 121. Details of estate maps showing Trefignath Farm (Penrhos II Estate Maps, images courtesy of Archives and Special Collections, Bangor University)

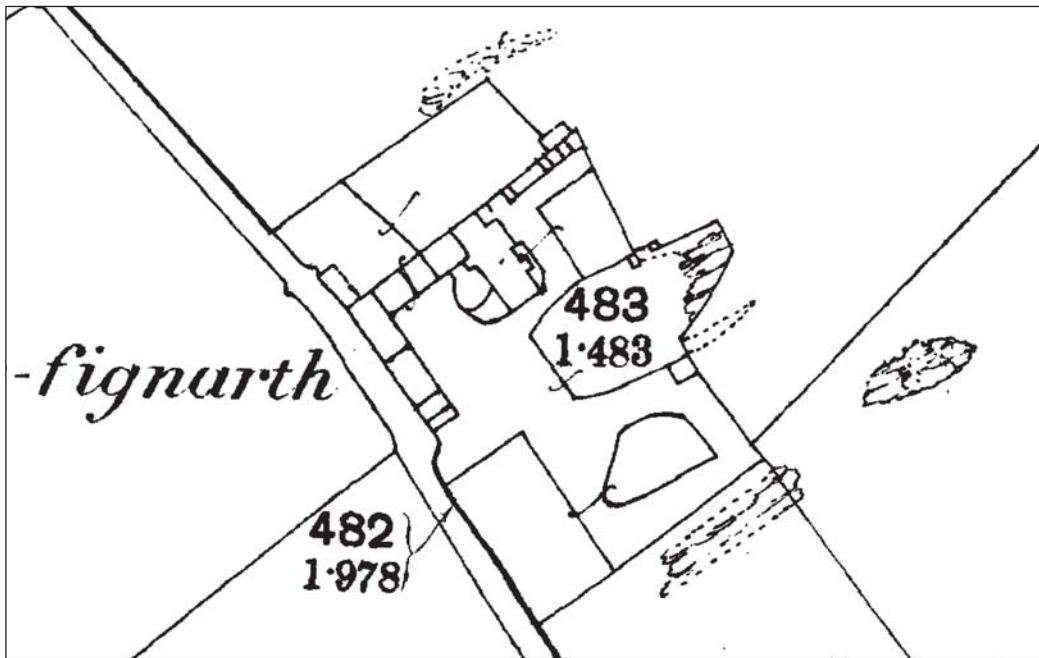

Trefignath Farm on first edition 1889 map

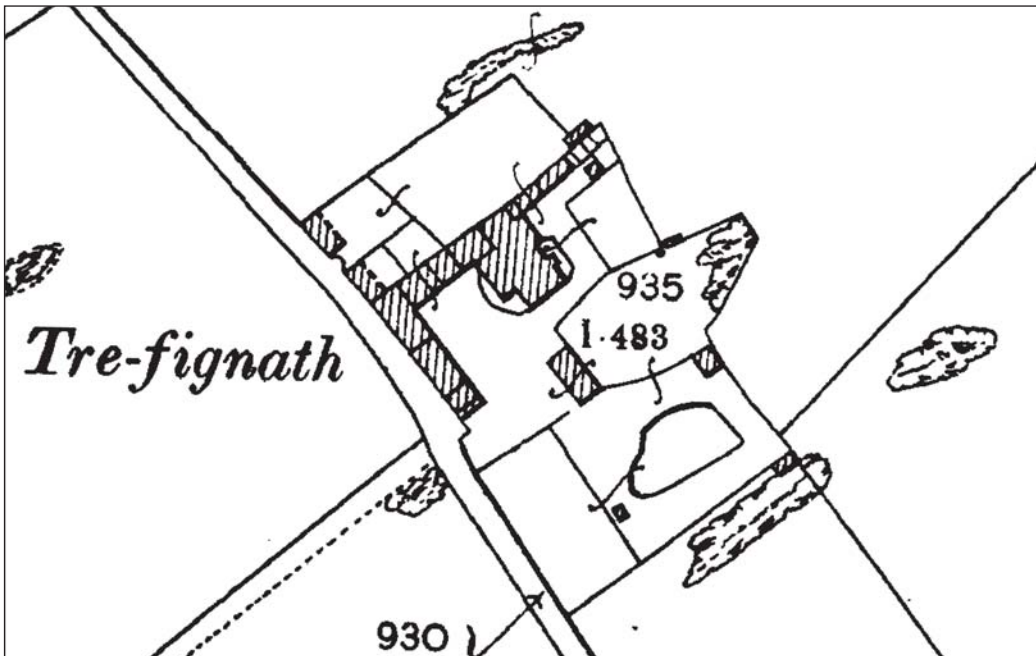

Trefignath Farm on second edition 1900 map

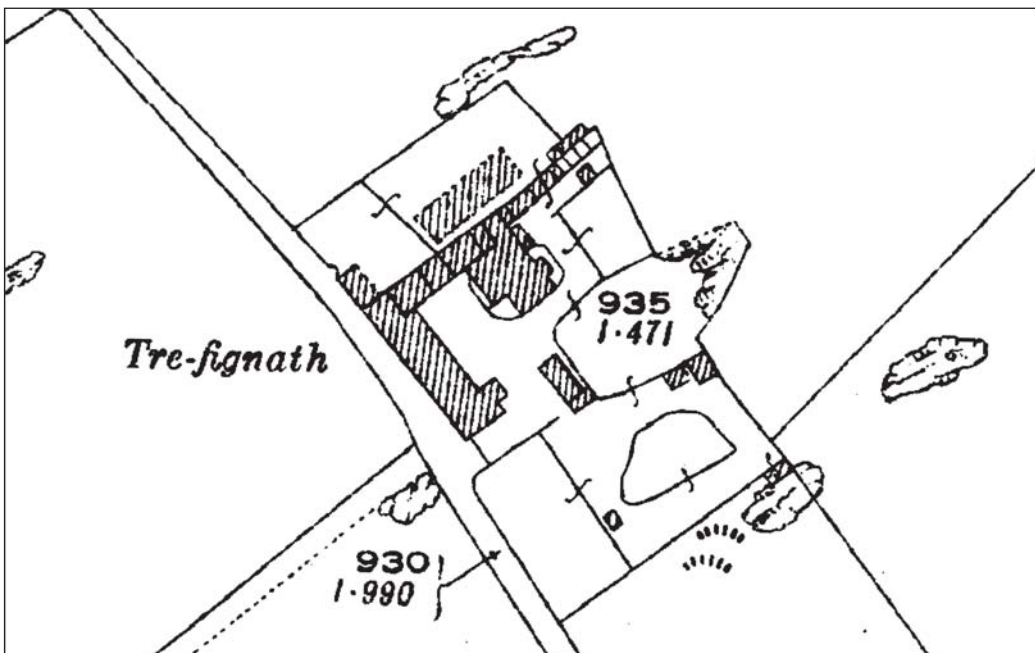

Trefignath Farm on third edition 1924 map

Figure 122. Trefignath Farm on the County Series 25 inch map (Anglesey sheet XI.07 first, second and third editions)

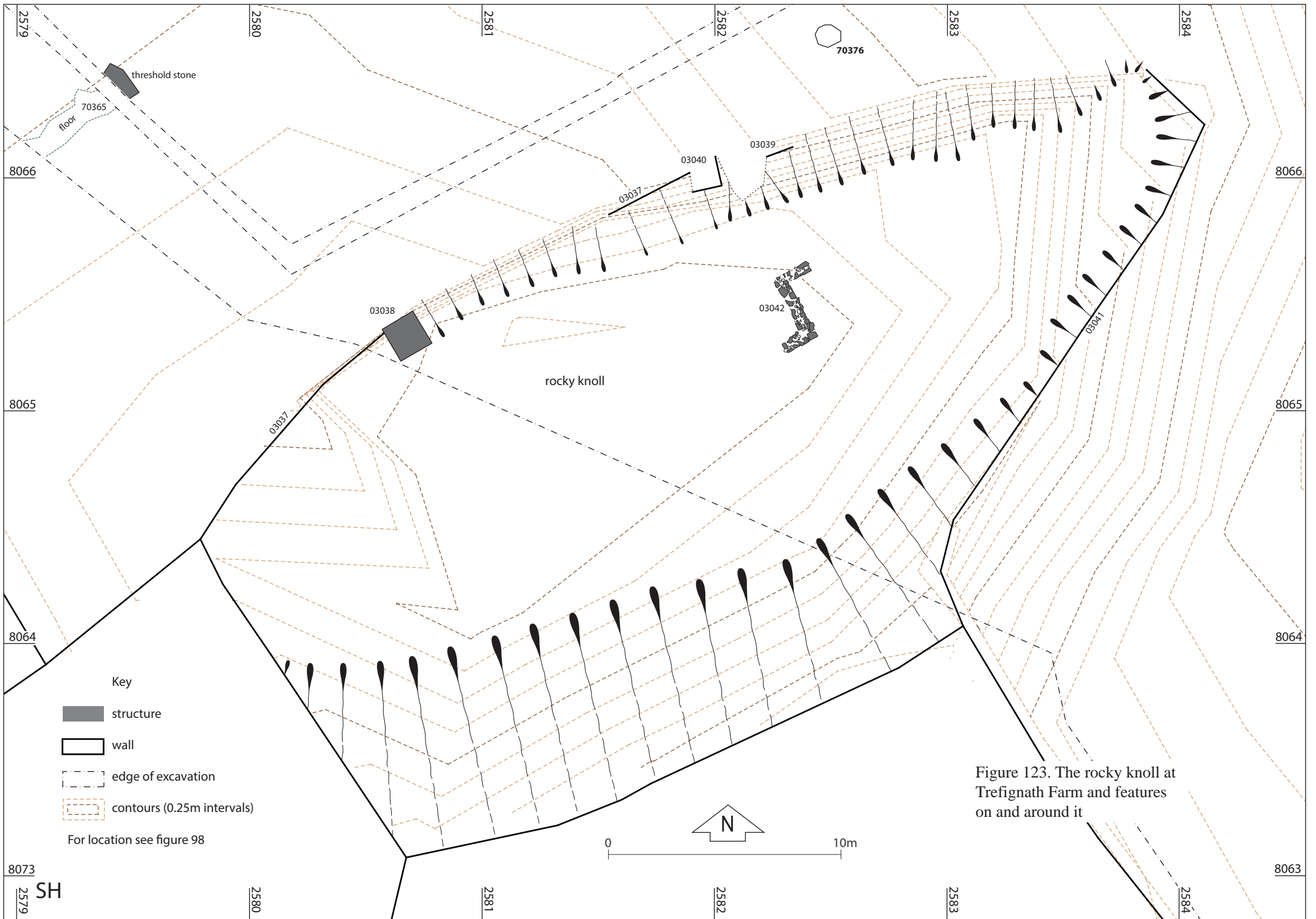



Merddyn Poeth on Penrhos II 772 (1769)

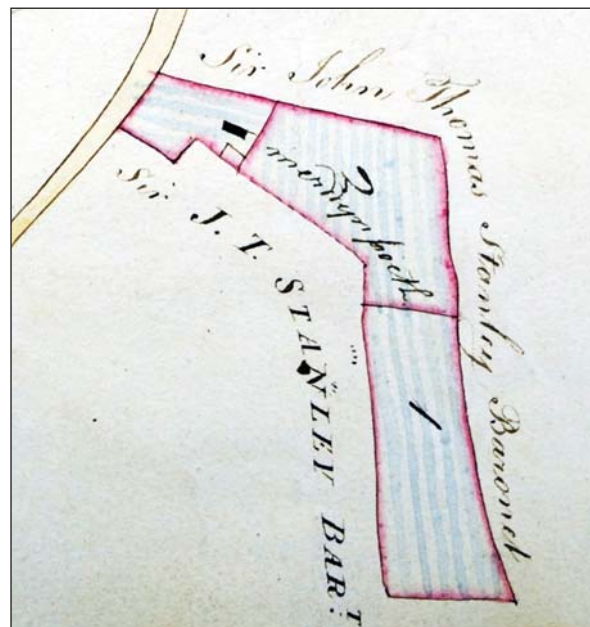

Merddyn Poeth on Penrhos III 208, p14 (1805)



Merddyn Poeth on Penrhos II 778 (1817)

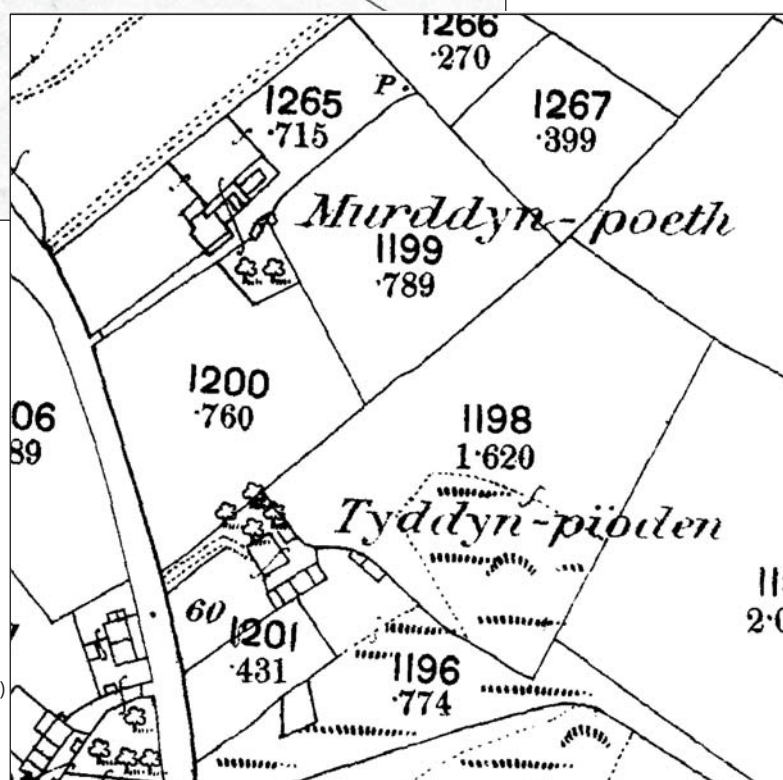

Merddyn Poeth on First Edition County Series 25 inch map (1889)

Figure 124. Details of maps showing Merddyn Poeth (PRN 36509) (Penrhos II Estate Maps, images courtesy of Archives and Special Collections, Bangor University)

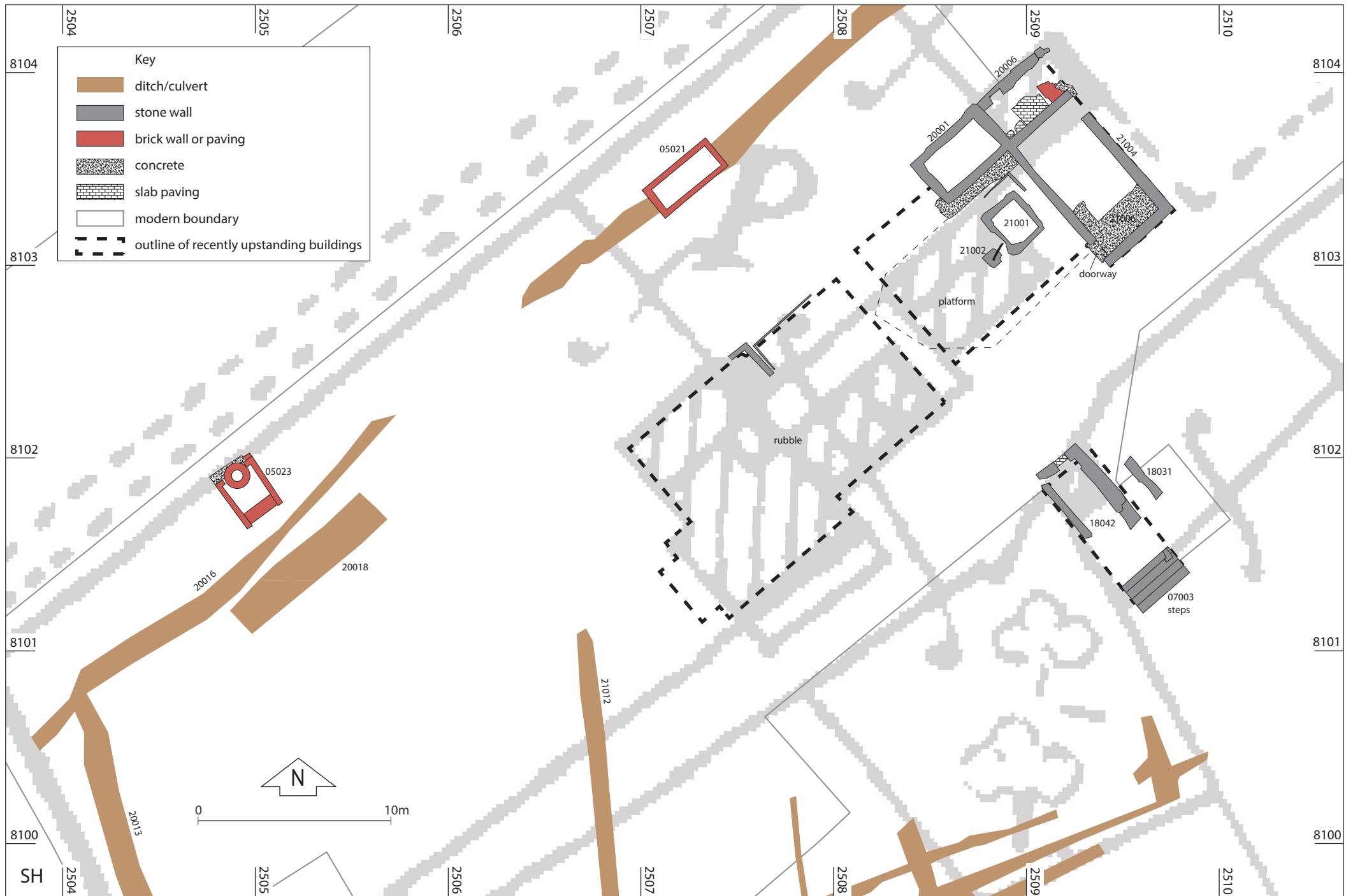

Figure 125. Plan of excavated features at Merddyn Poeth overlaid on second edition County Series map (1900)

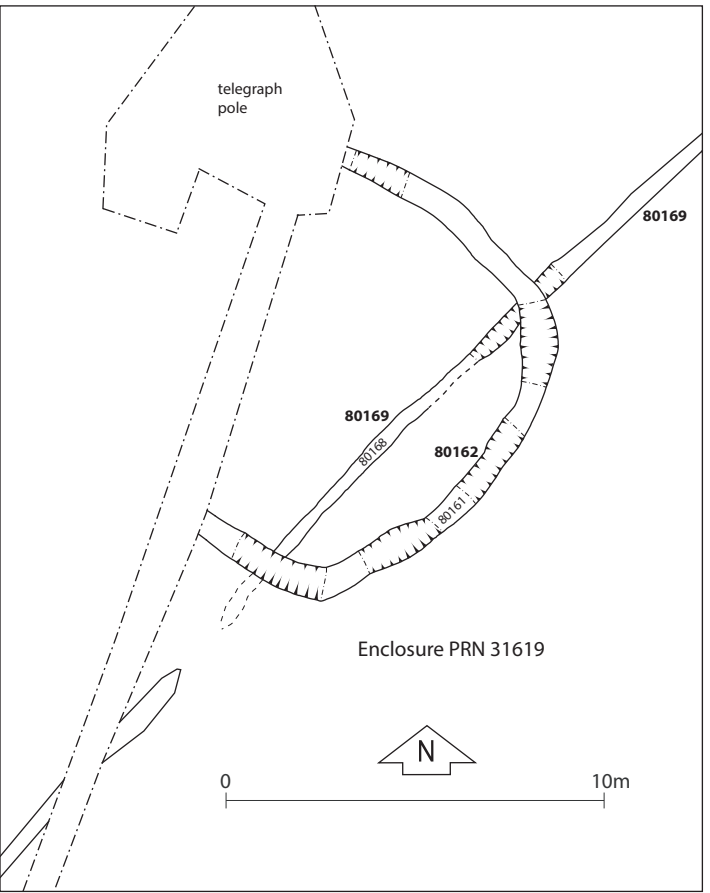
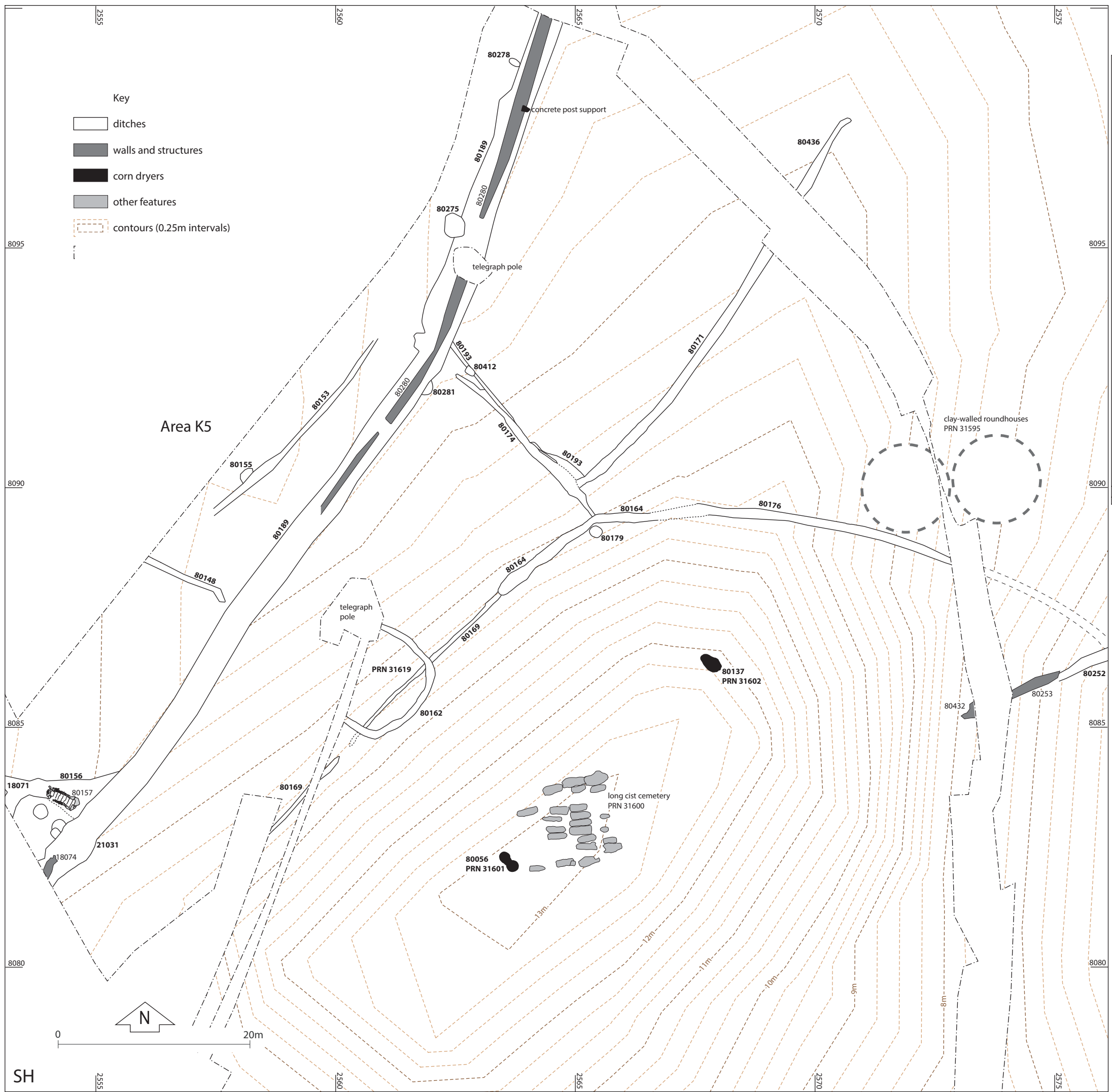

Figure 126. Field boundaries in Area K7 (PRN 31608), with inset showing gully PRN 31619

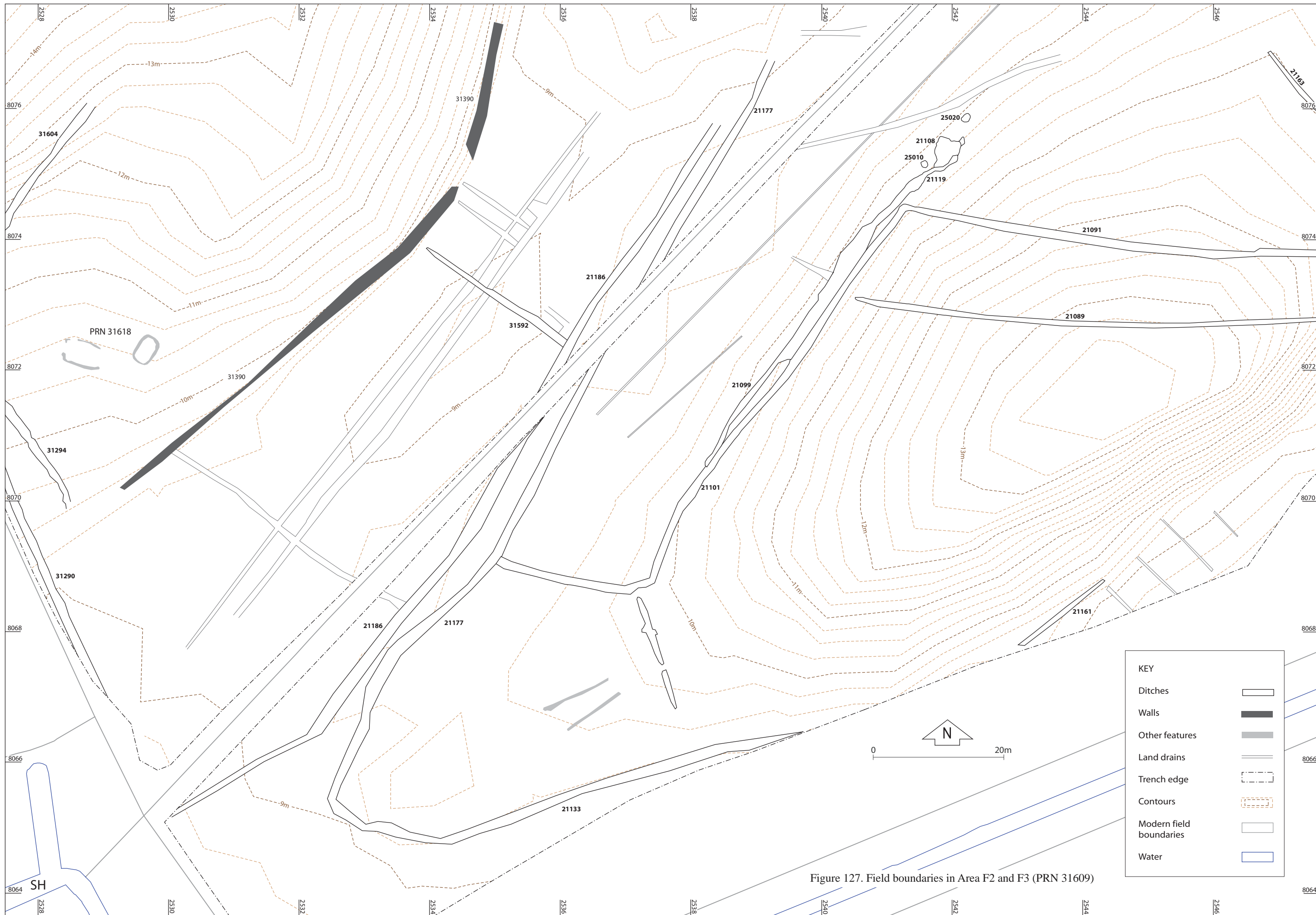

Figure 127. Field boundaries in Area F2 and F3 (PRN 31609)

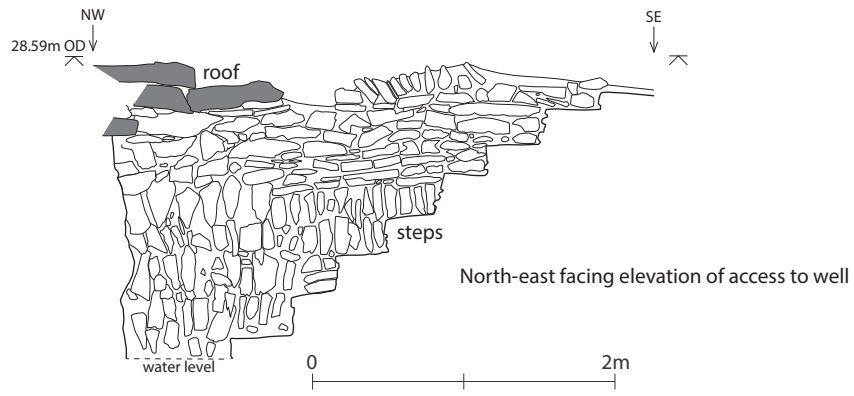
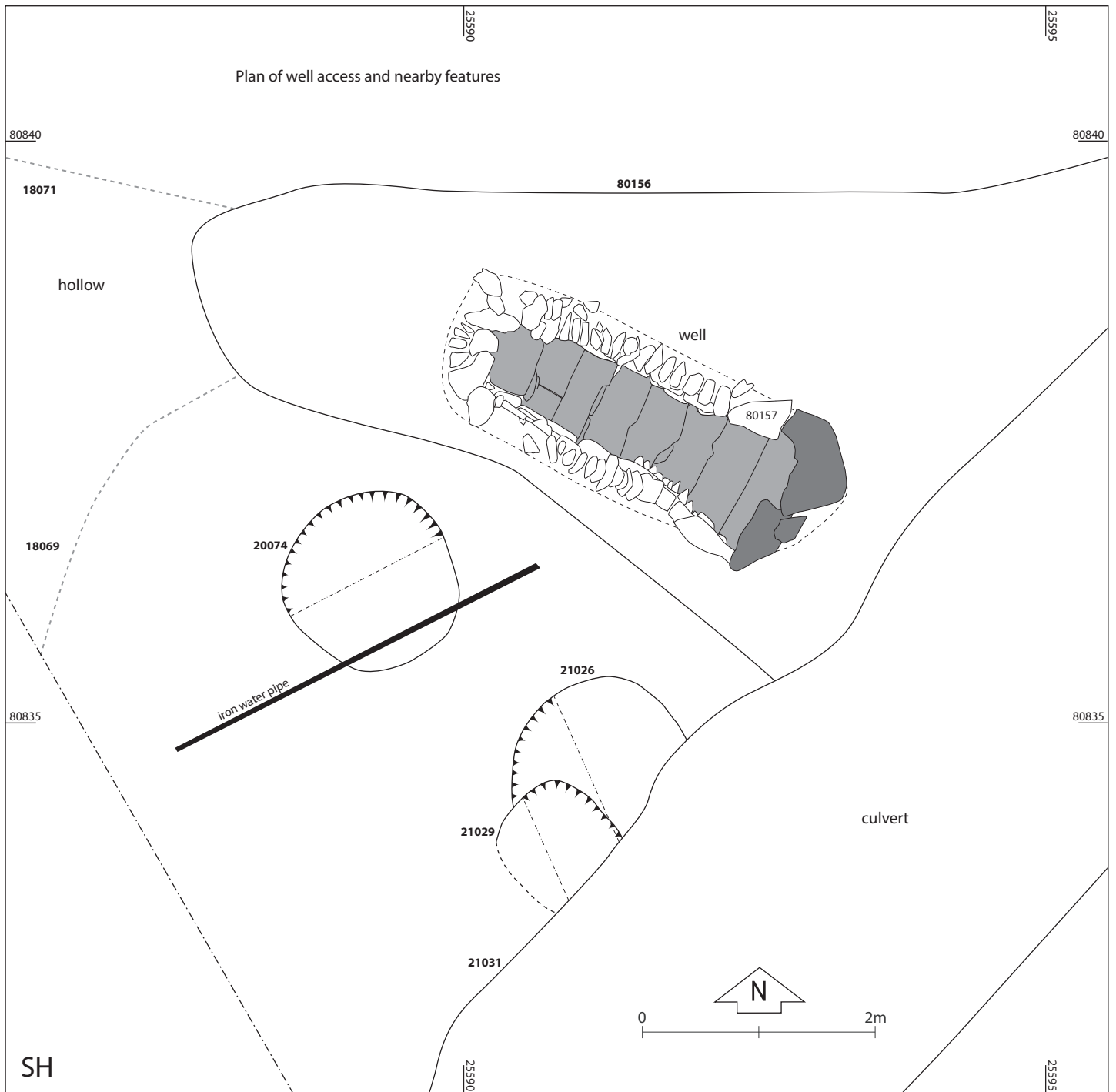

Figure 128. Plan and elevation of well PRN 31614



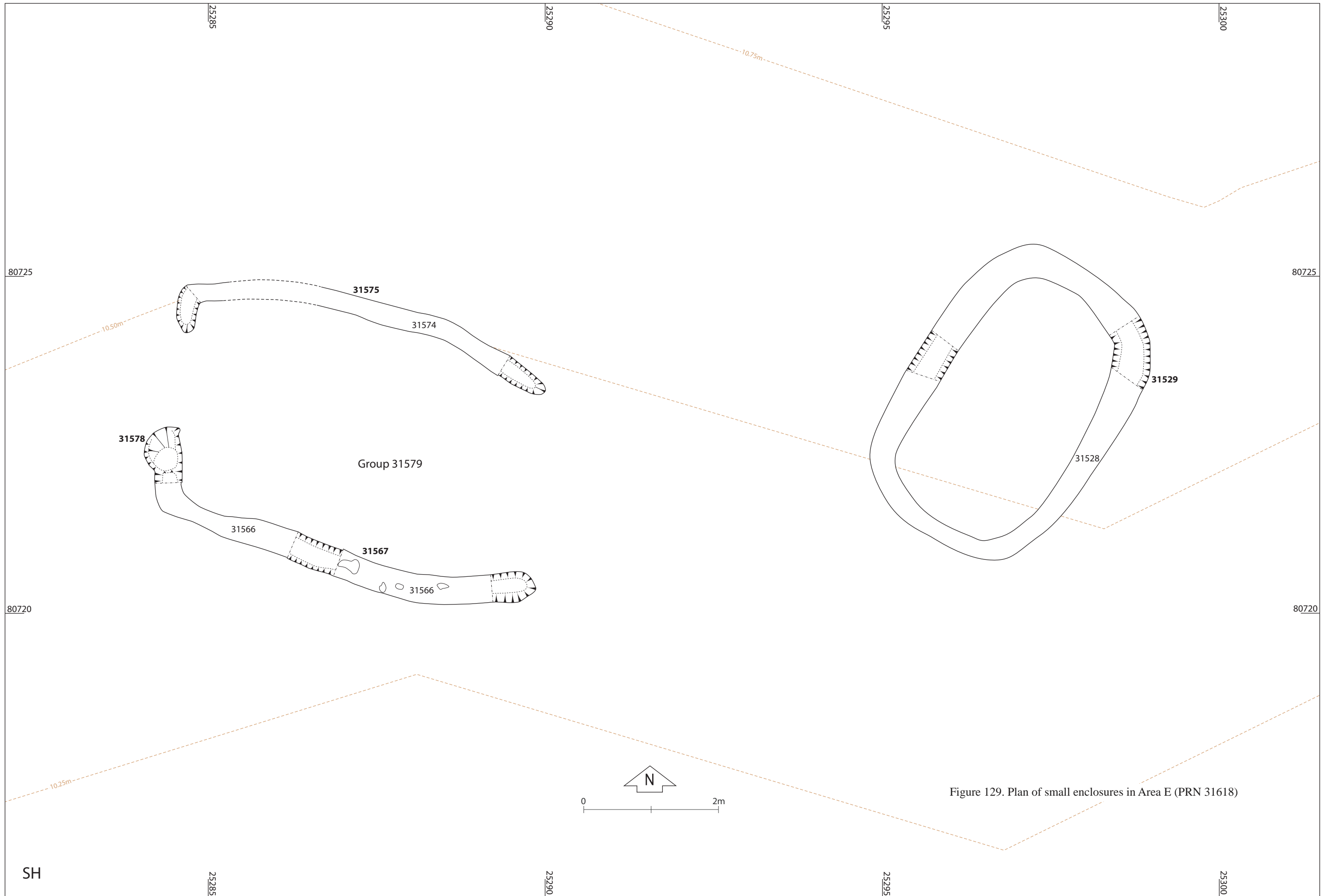
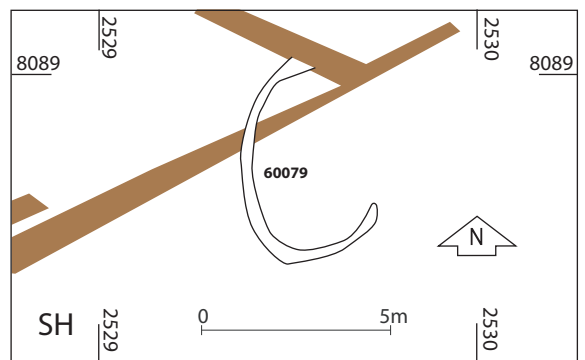
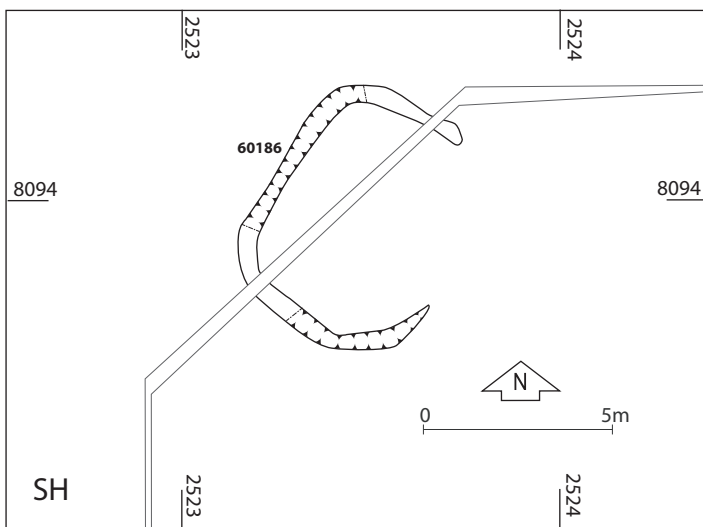
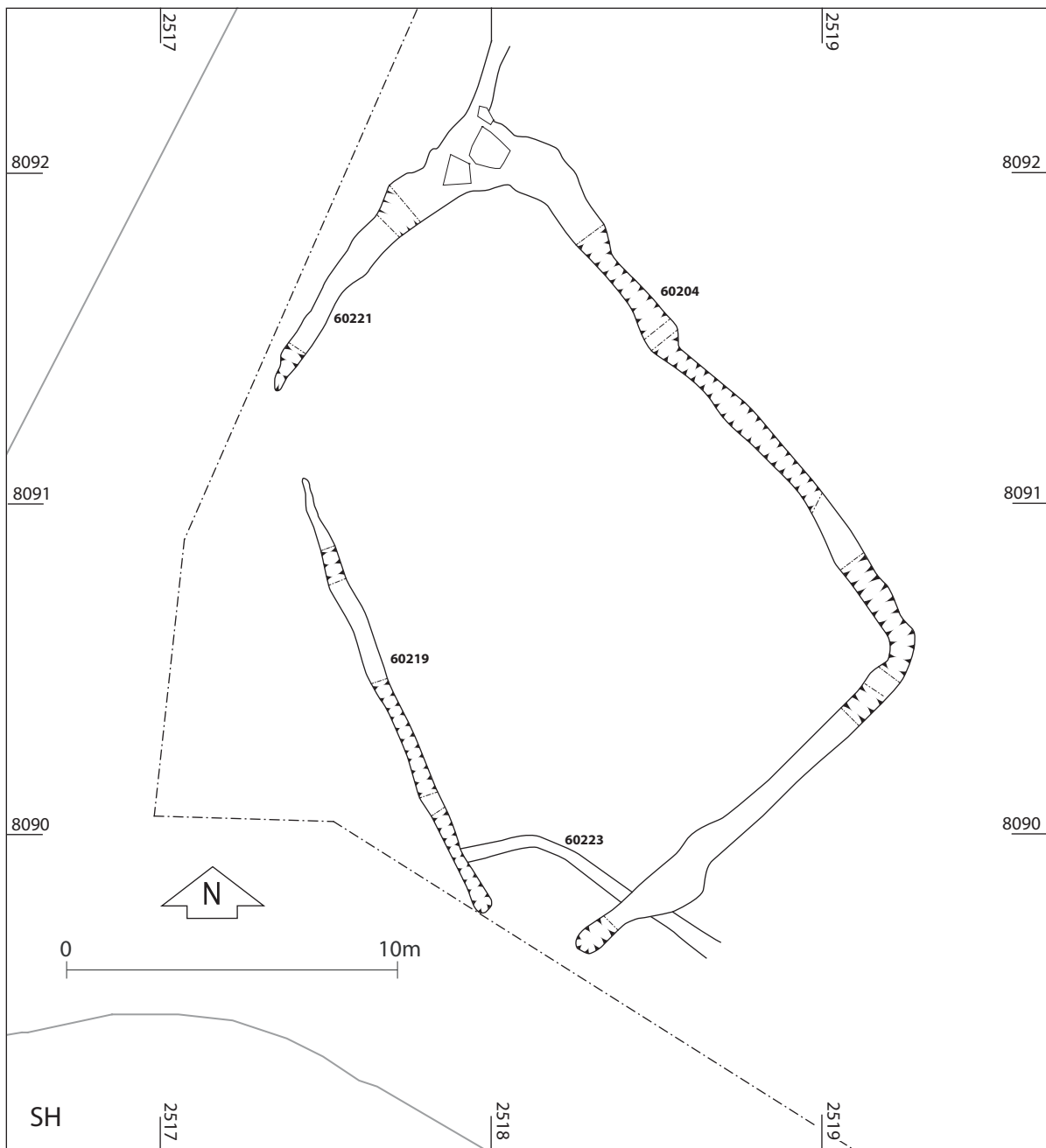

Figure 129. Plan of small enclosures in Area E (PRN 31618)



Key





-  Field boundary
-  Edge of excavation
-  Land drain
-  Post medieval ditch

Figure 130. Small enclosures in Area D3

KEY

- Early Neolithic pottery
- Mortlake pottery
- Fengate pottery
- Grooved ware
- Beaker pottery
- Food vessels
- Mid Bronze Age pottery
- Cordoned urn

Size of the circle indicates quantity of pottery
For other symbols and line types see figure 7

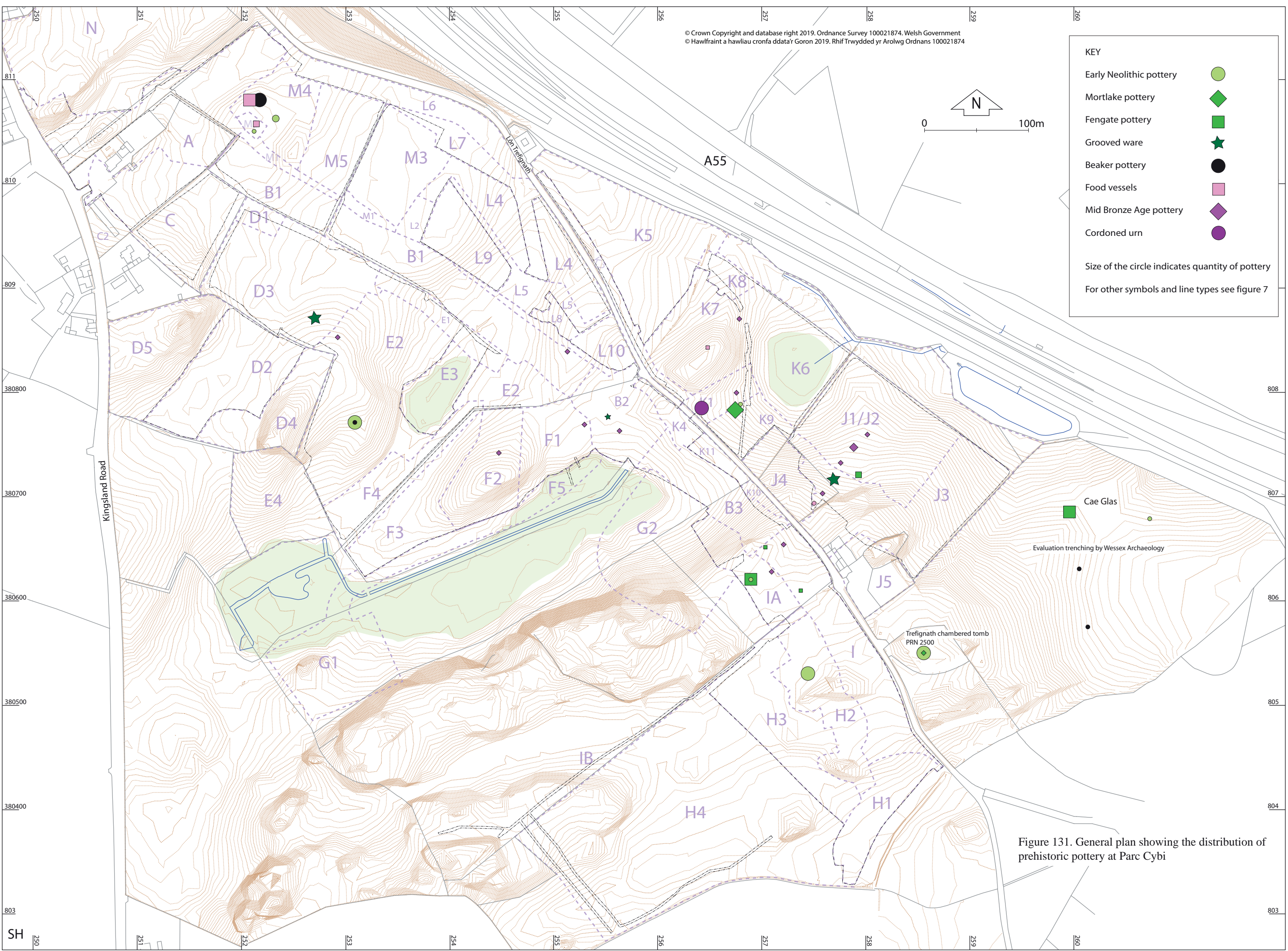
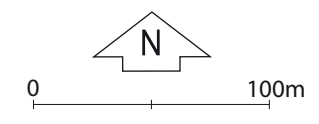
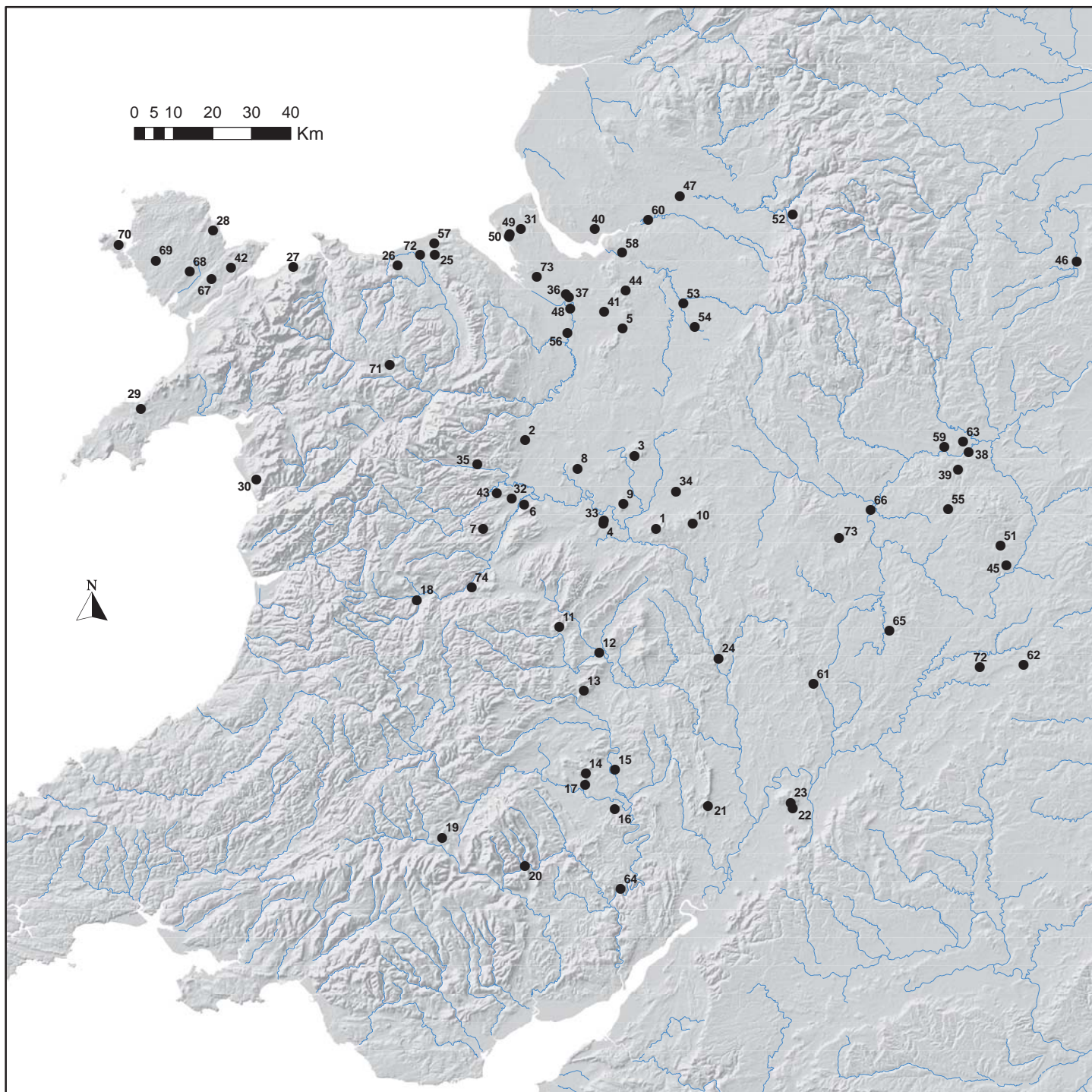

Figure 131. General plan showing the distribution of prehistoric pottery at Parc Cybi



1	The Wrekin, Shropshire	21	Midsummer Hill, Herefordshire	41	Bruen Stapleford, Cheshire	61	Brockhill Lane, Redditch, Worcestershire
2	Old Oswestry, Shropshire	22	Beckford II, Worcestershire	42	Bryn Eryr, Anglesey	62	Crick Covert Farm, Daventry, Northamptonshire
3	Bury Walls, Shropshire	23	Danes' Camp, Conderton, Worcestershire	43	Collfryn, Powys	63	Foxcovert Farm, Aston-on-Trent, Derbyshire
4	Sharpstones Hill - Site A, Shropshire	24	Blackstone, Worcestershire	44	Eddisbury, Cheshire	64	Little Doward (hillfort), Ganarew, Herefordshire
5	Beeston Castle, Cheshire	25	Moel Hiraddug, Denbighshire	45	Enderby, Leicestershire	65	Meriden Quarry, Solihull, Warwickshire
6	The Breidden, Powys	26	Dinorben, Conwy	46	Gamston, Nottinghamshire	66	Whitemoor Haye Quarry, Staffordshire
7	Fisherwick, Staffordshire	27	Braich-y-Ddinas, Gwynedd	47	Great Woolden Hall, Salford	67	Cefn Cwmwd, Rhostrehwfa, Anglesey
8	The Berth, Shropshire	28	Pant-y-Saer, Anglesey	48	Handbridge, Cheshire	68	Cefn Du, Gaerwen, Anglesey
9	Ebury Hill, Shropshire	29	Garn Boduan, Gwynedd	49	Irby, Mill Hill Road, Wirral	69	Melin-y-Plas, Bryngwran, Anglesey
10	Castle Farm, Shropshire	30	Pen Dinas, Llanaber, Gwynedd	50	Irby, Telegraph Road, Wirral	70	Parc Cybi, Anglesey
11	Burrow Hill, Shropshire	31	Landican, Wirral	51	Kirby Muxloe, Leicestershire	71	Ty Tan-y-foel, Cerrigydrudion, Clywd
12	Bromfield enclosure, Shropshire	32	Arddleen, Powys	52	Mellor, Stockport	72	Calvestone Road, Cawston, Warwickshire
13	Croft Ambrey, Herefordshire	33	Sharpstones Hill-Site E, Shropshire	53	Middlewich, Cheshire	73	Circus Field, Lichfield, Staffordshire
14	Credenhill, Herefordshire	34	Wall Camp, Kynnersley, Shropshire	54	Moston, Cheshire		
15	Sutton Walls, Herefordshire	35	Llywn Bryn-Dinas, Powys	55	Normanton-le-Heath, Leicestershire		
16	Dinedor, Herefordshire	36	Abbey Green, Chester	56	Poulton, Cheshire		
17	Kenchester enclosure, Herefordshire	37	Amphitheatre, Chester	57	Prestatyn, Denbighshire		
18	Cefn Carnedd, Powys	38	Aston upon Trent, Derbyshire	58	Sutton Weaver, Cheshire		
19	Twyn Llechfaen, Powys	39	Breedon-on-the-Hill, Leicestershire	59	Swarkestone Lowes, Derbyshire		
20	Twyn-y-Gaer, Powys	40	Brook House Farm, Halewood, Knowsley	60	Wilderspool, Cheshire		

Figure 132. Distribution of Cheshire Salt Containers (map by Dr Rob Philpott, up-dated version of Philpott 2010, fig 5.5, reproduced with kind permission)

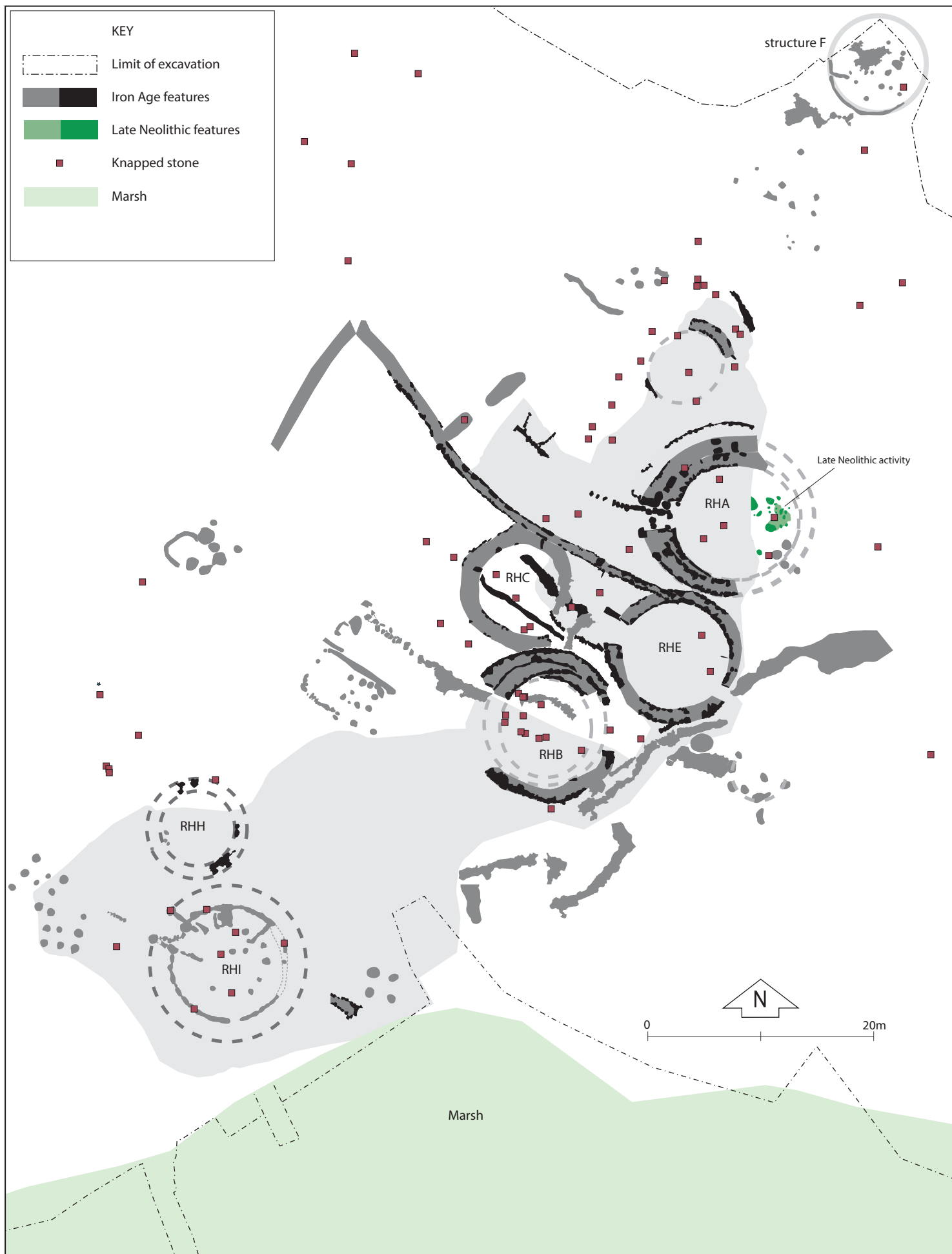
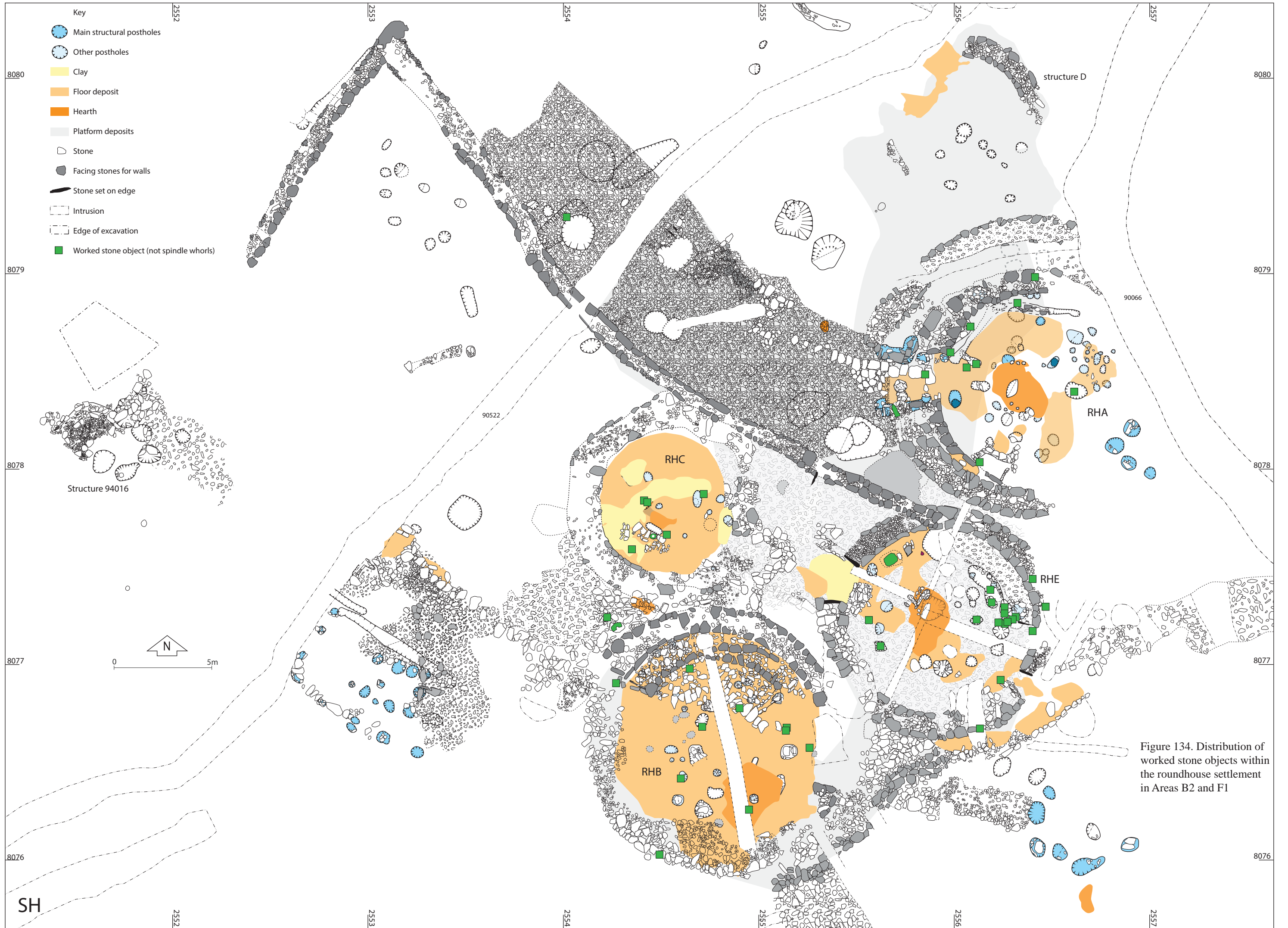
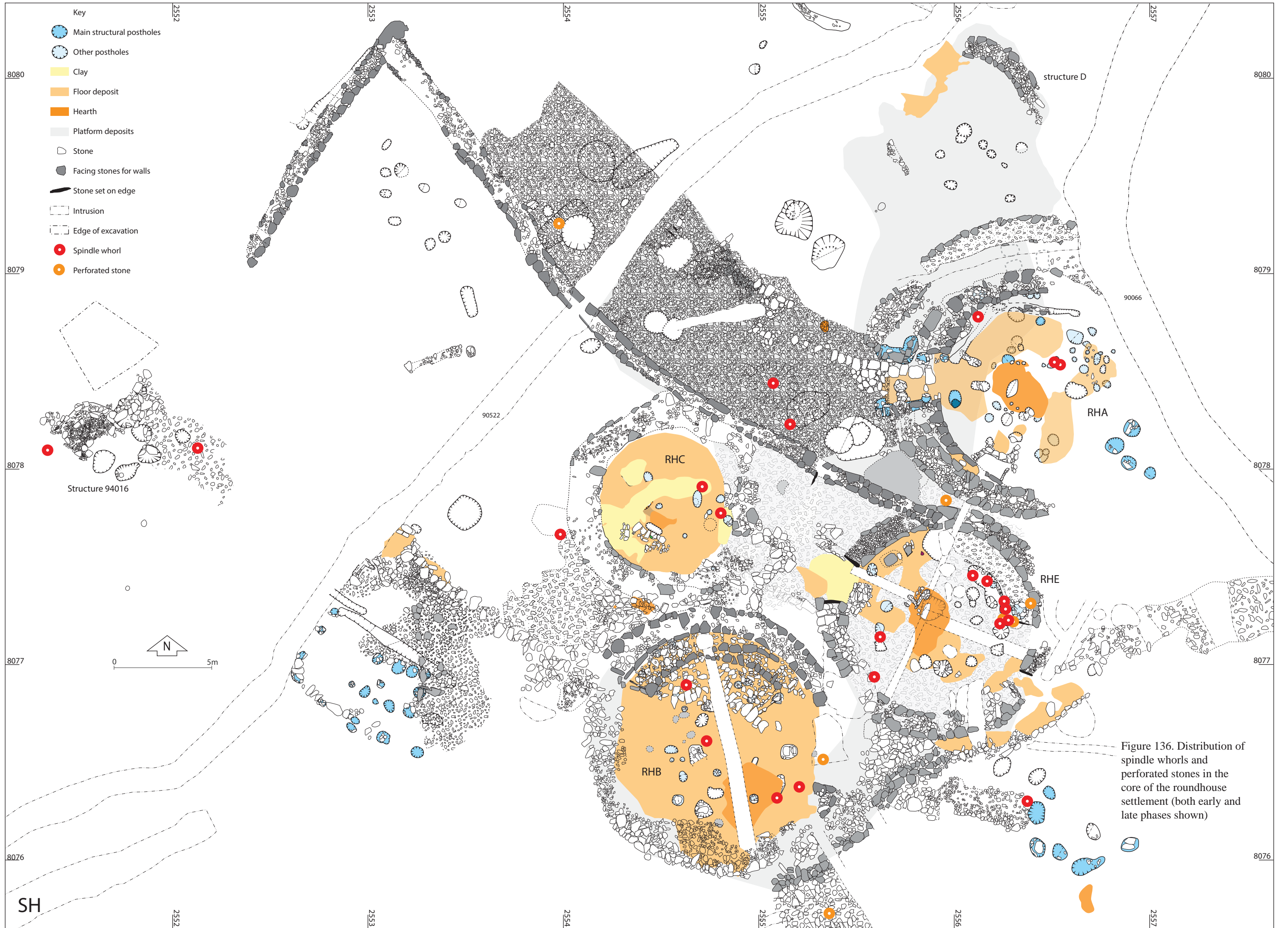
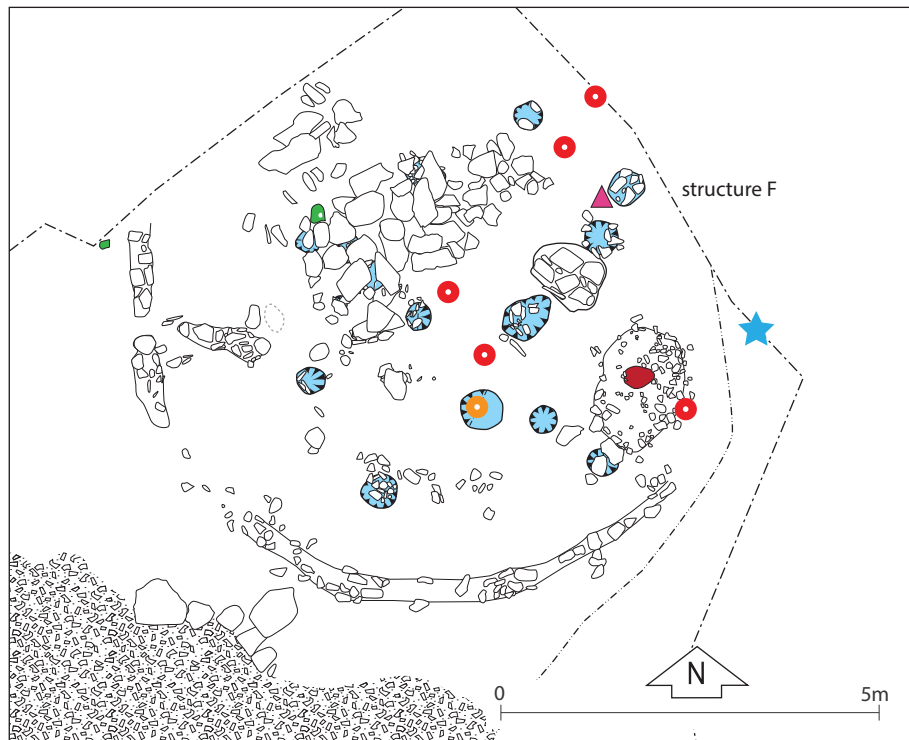
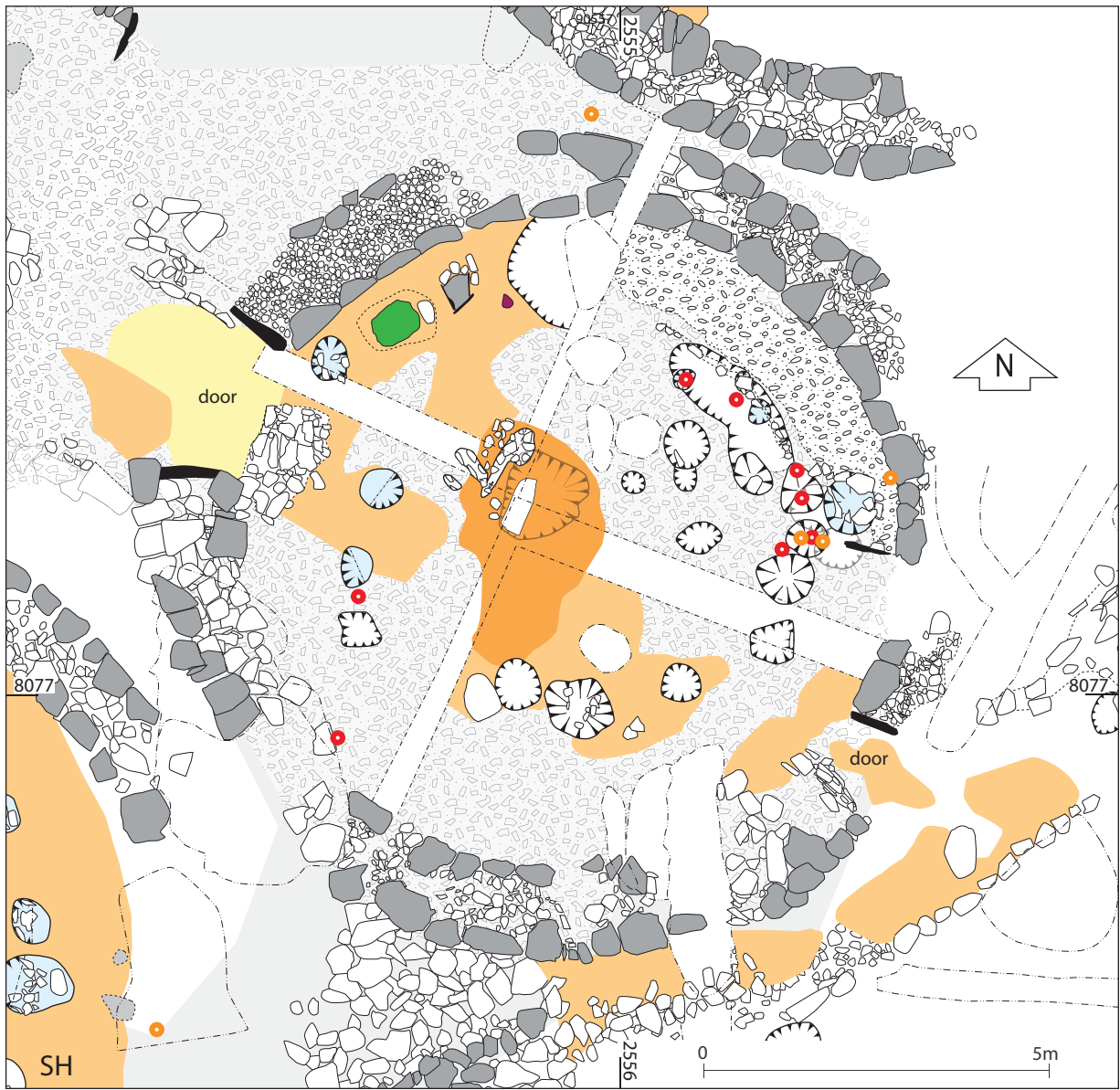

Figure 133. Distribution of knapped stone within the roundhouse settlement in Areas B2 and F1









- Key
- spindle whorl
 - perforated weight
 - ▲ Roman pot
 - ★ shale bangle fragment
 - large stone objects

Figure 137. Distribution of spindle whorls, perforated stones and shale objects in roundhouse E and structure F

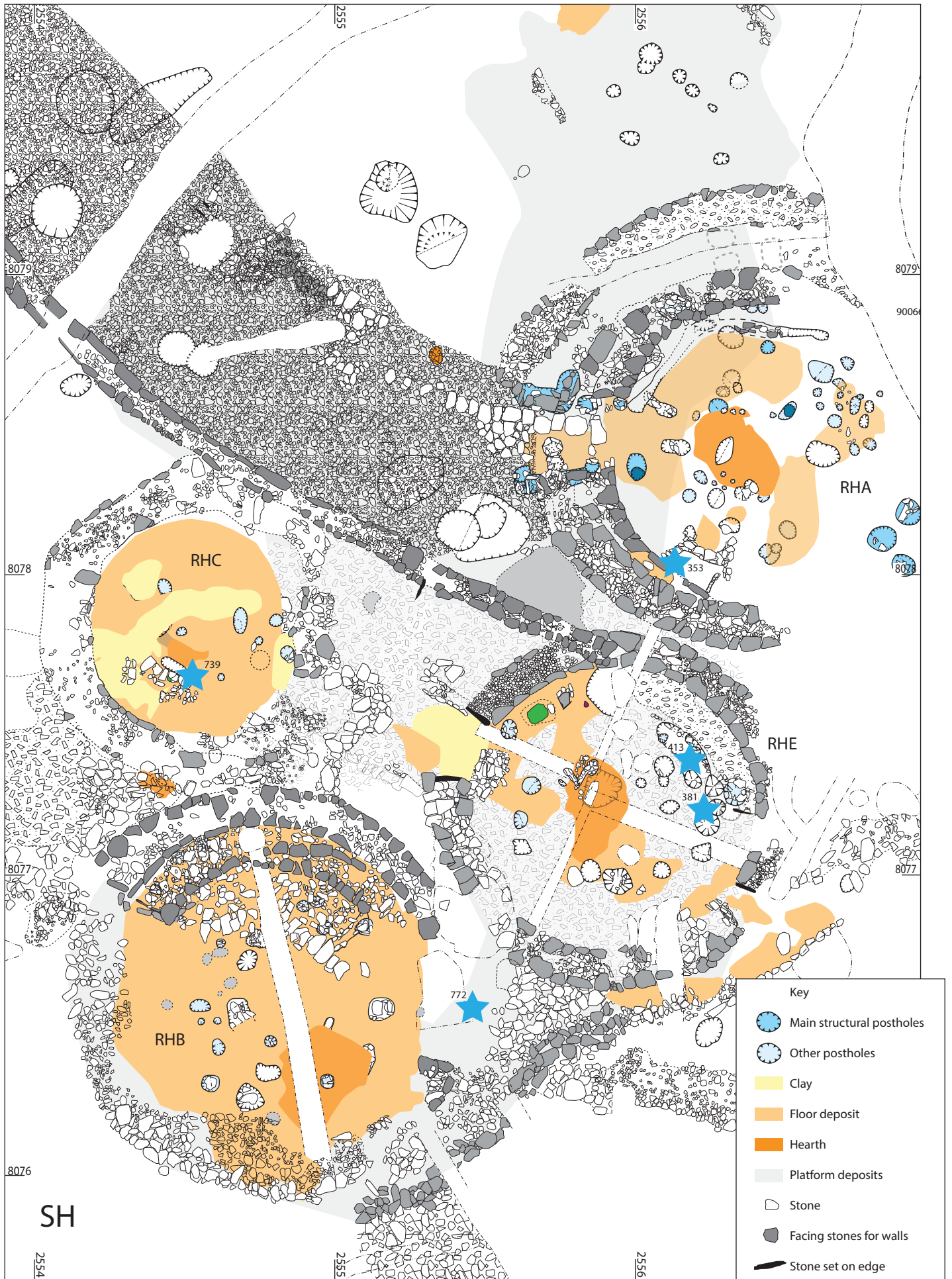
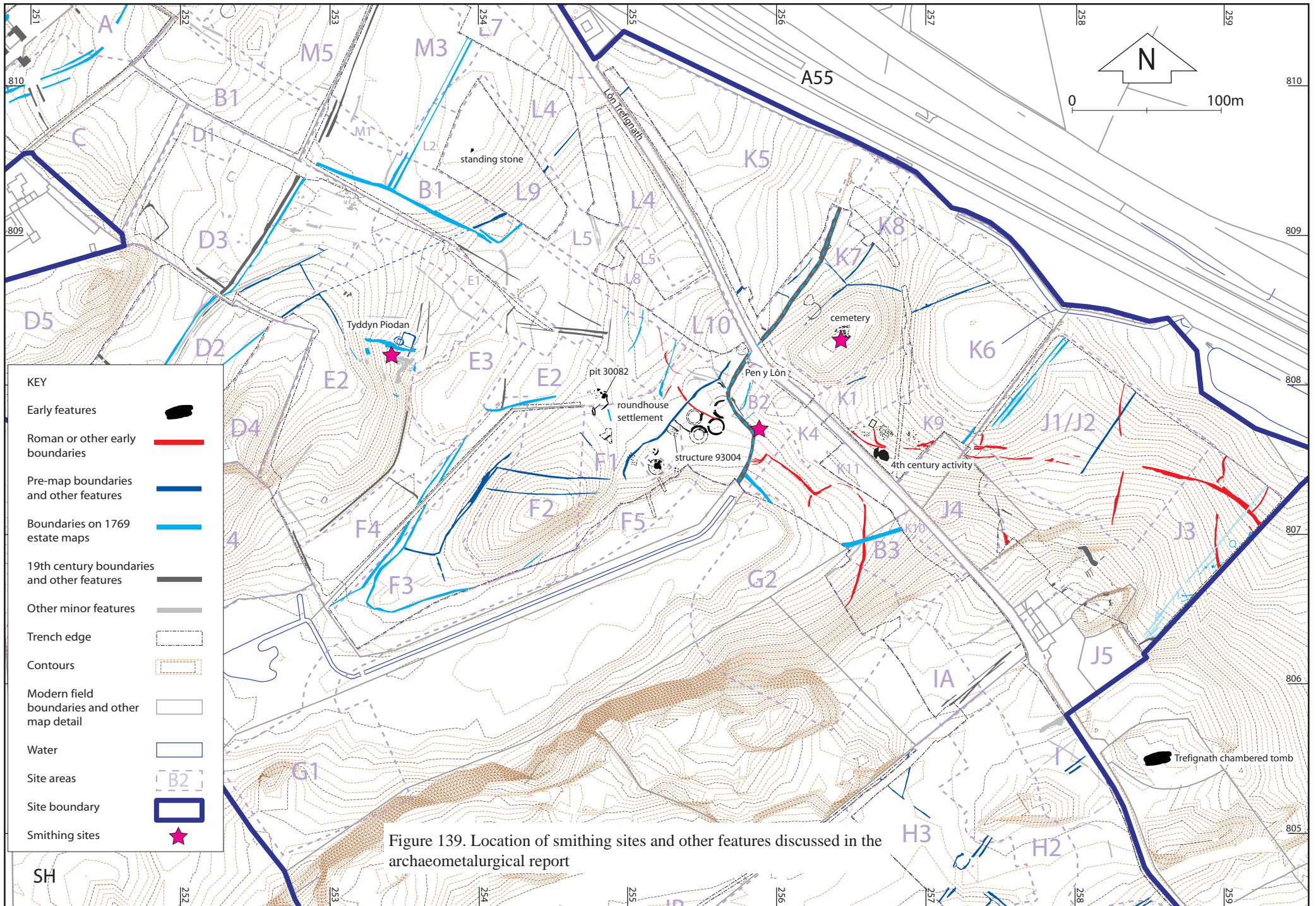

Figure 138. Distribution of shale objects in the roundhouse settlement in Area B2



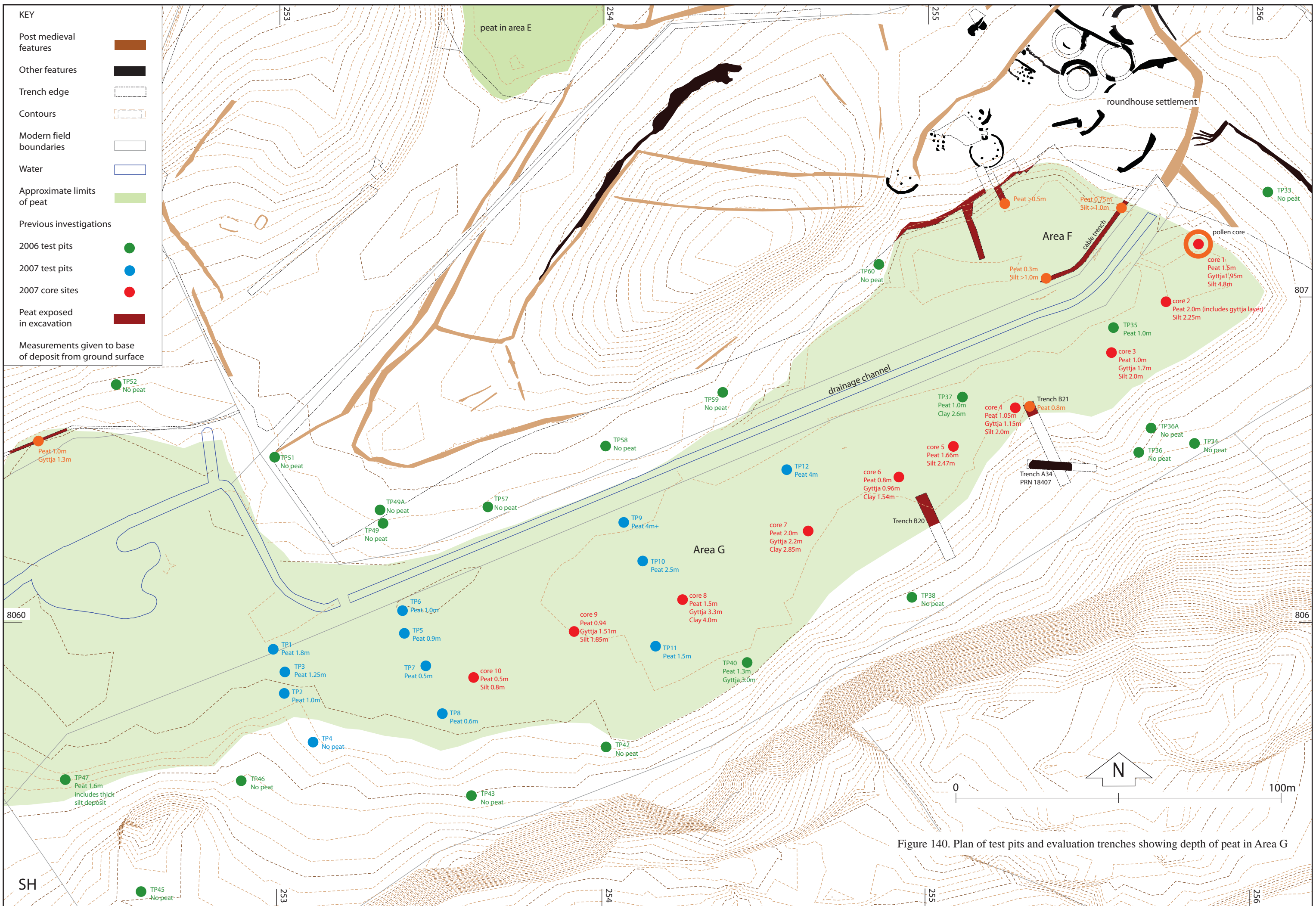

Figure 140. Plan of test pits and evaluation trenches showing depth of peat in Area G

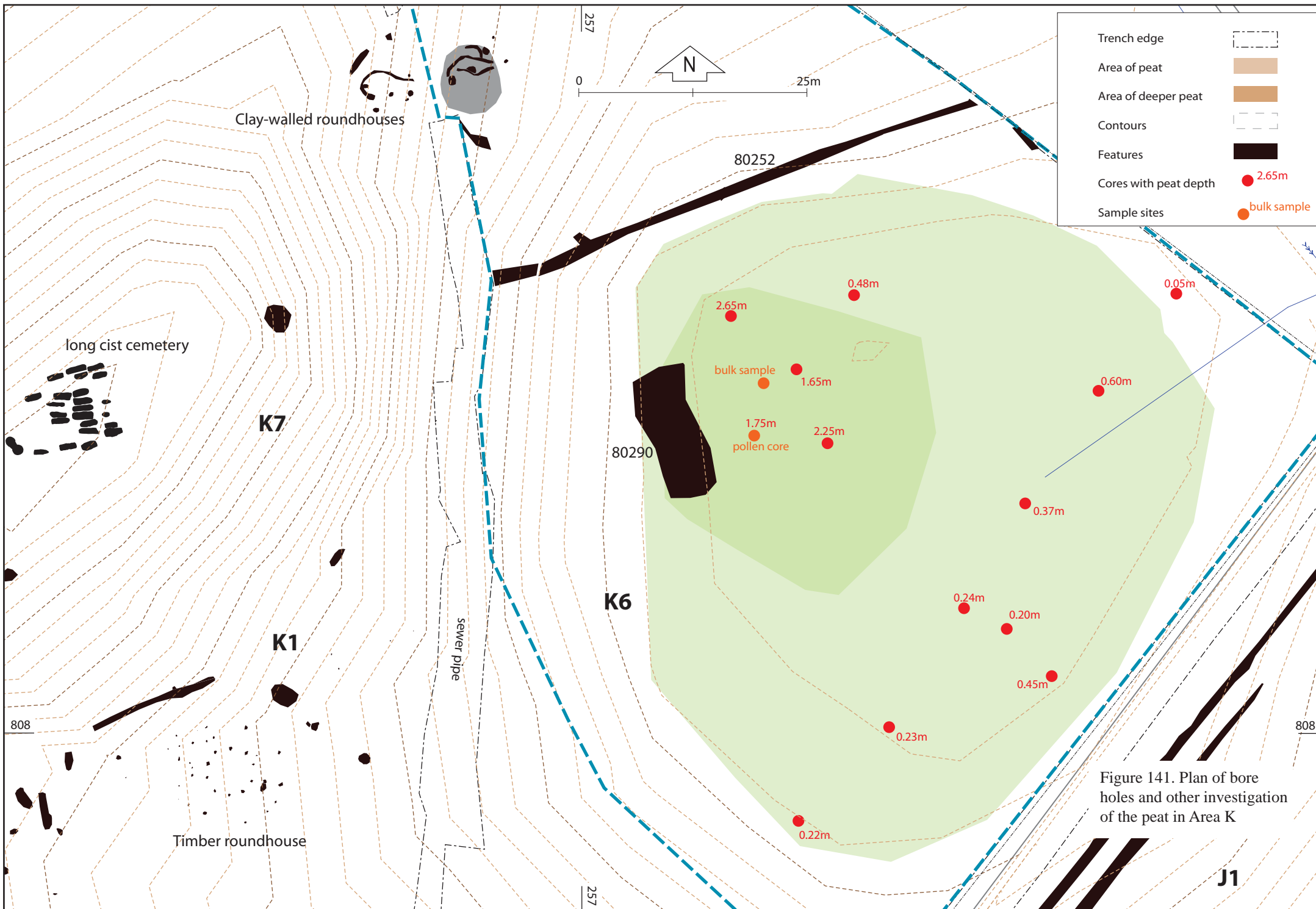

Figure 141. Plan of bore holes and other investigation of the peat in Area K

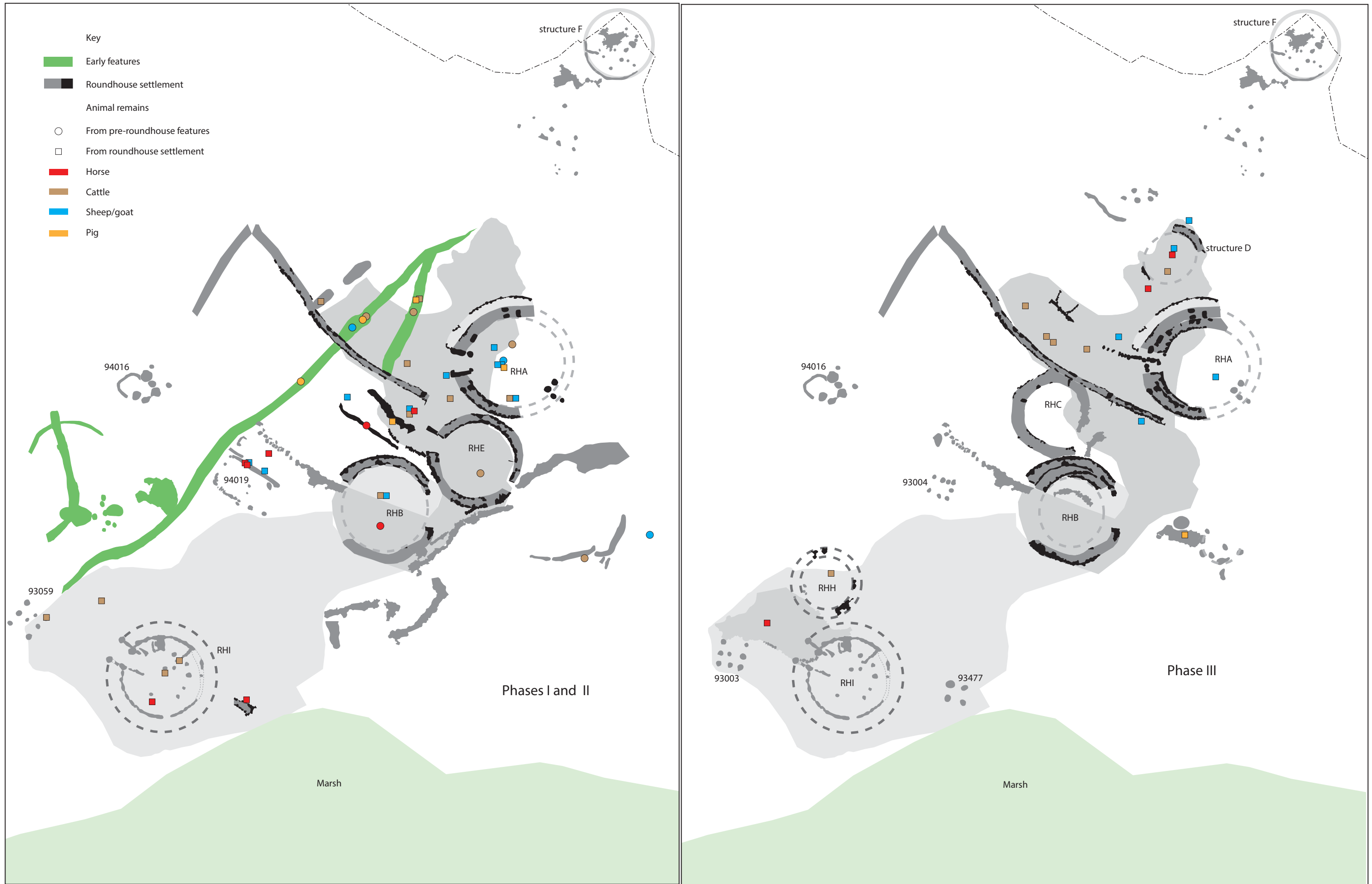

Figure 142. Distribution of animal remains identifiable to species in the three phases of the roundhouse settlement in Areas B2/F1

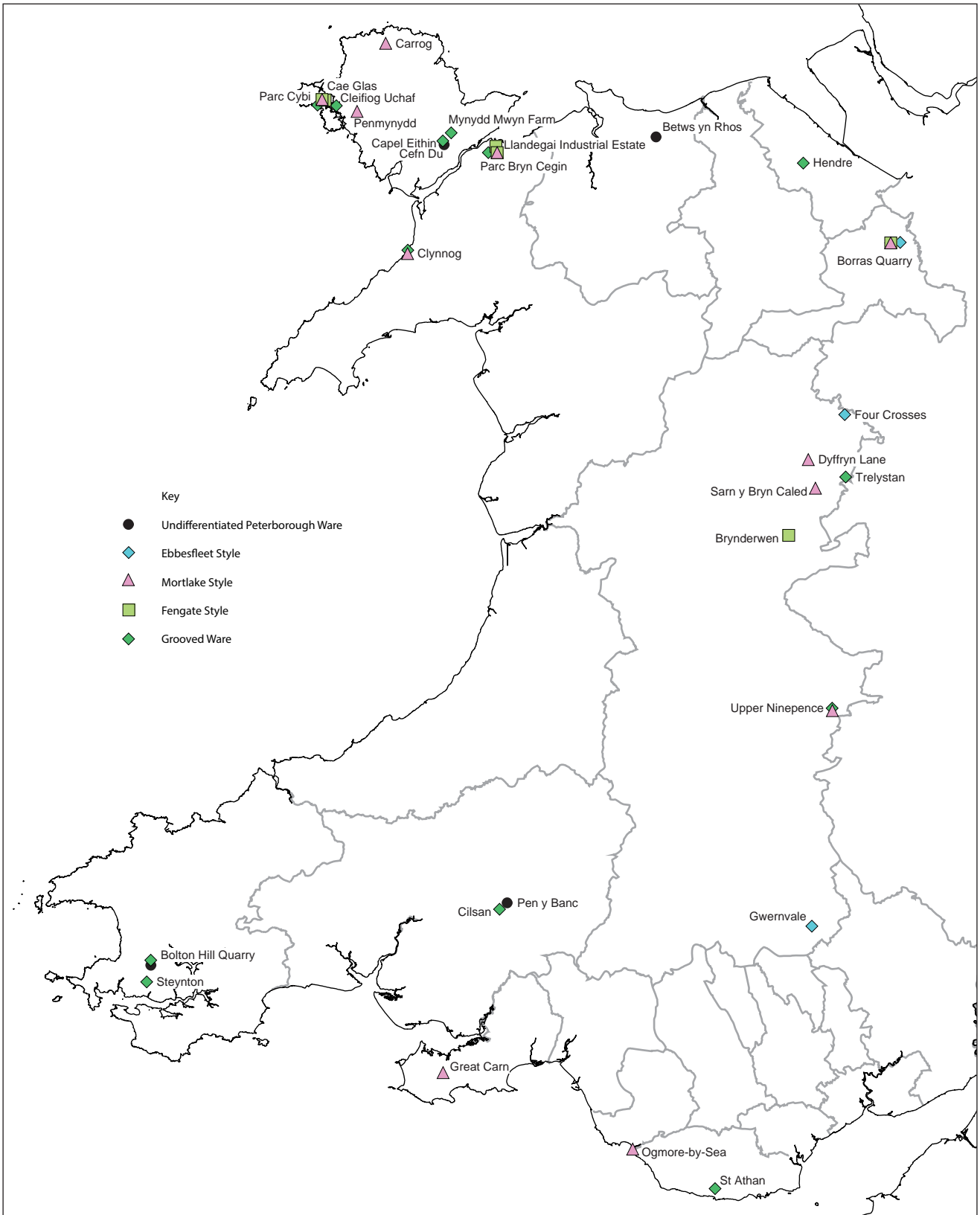

Figure 143. Location of sites in Wales with dated Middle and Late Neolithic pottery

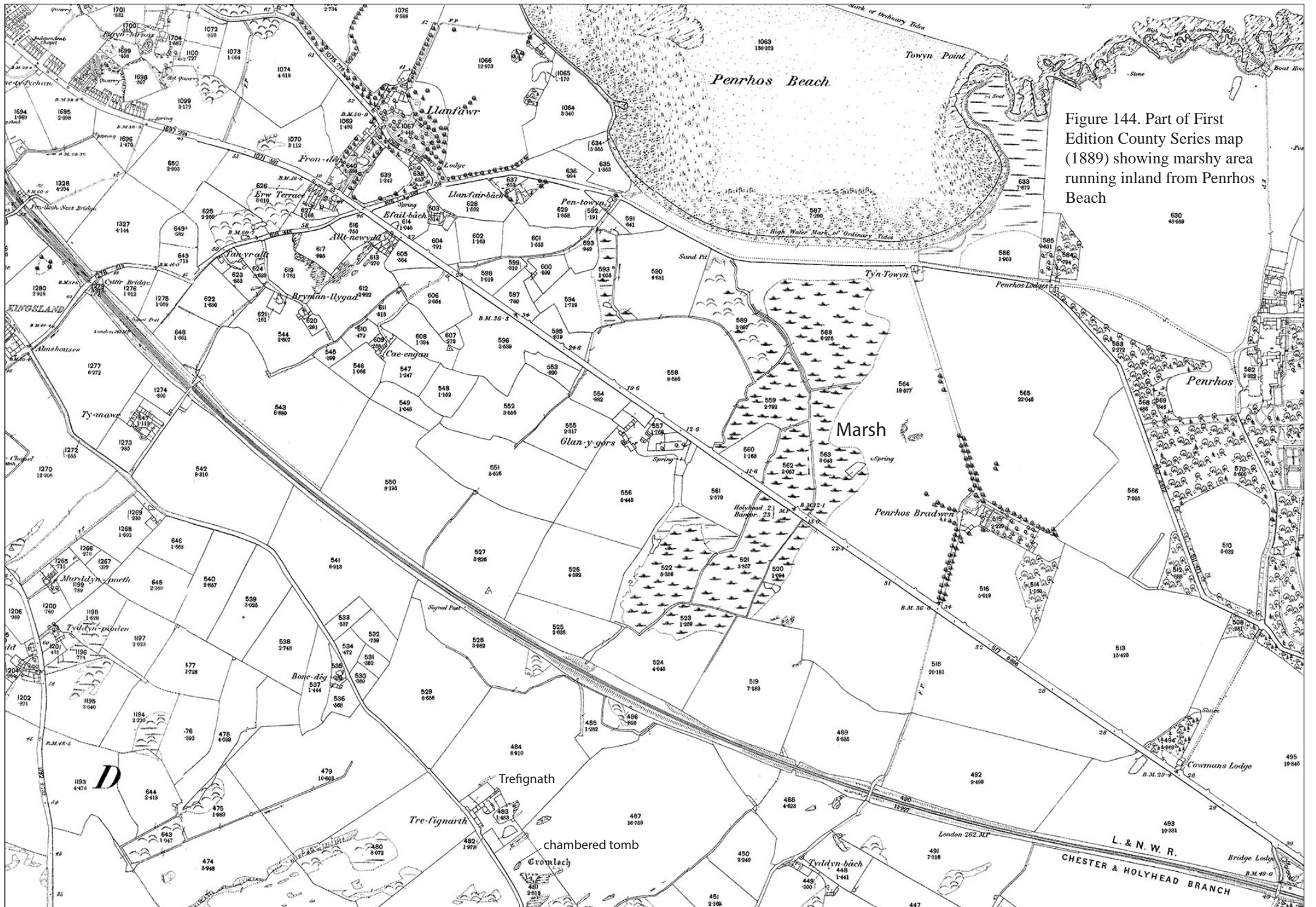

Figure 144. Part of First Edition County Series map (1889) showing marshy area running inland from Penrhos Beach

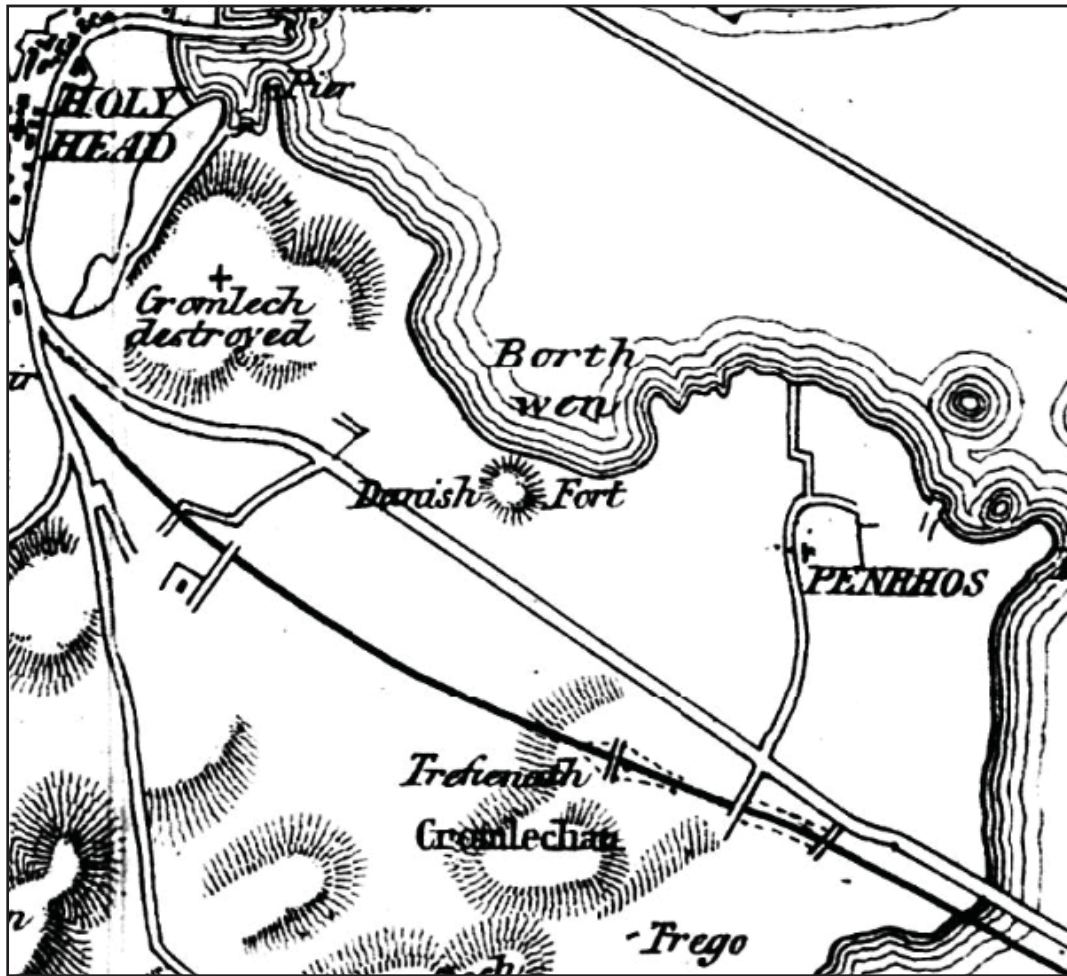

Figure 145. Extract from Stanley's map "Group of Ancient Habitations called Cytiau'r Gwyddelod, SE Flank of Holyhead Mountain" showing the "Danish fort" at Borth Wen (Stanley 1868, map opposite p385)



Figure 146. Map showing relationship of Bronze Age monuments at Parc Cybi to Holyhead Mountain

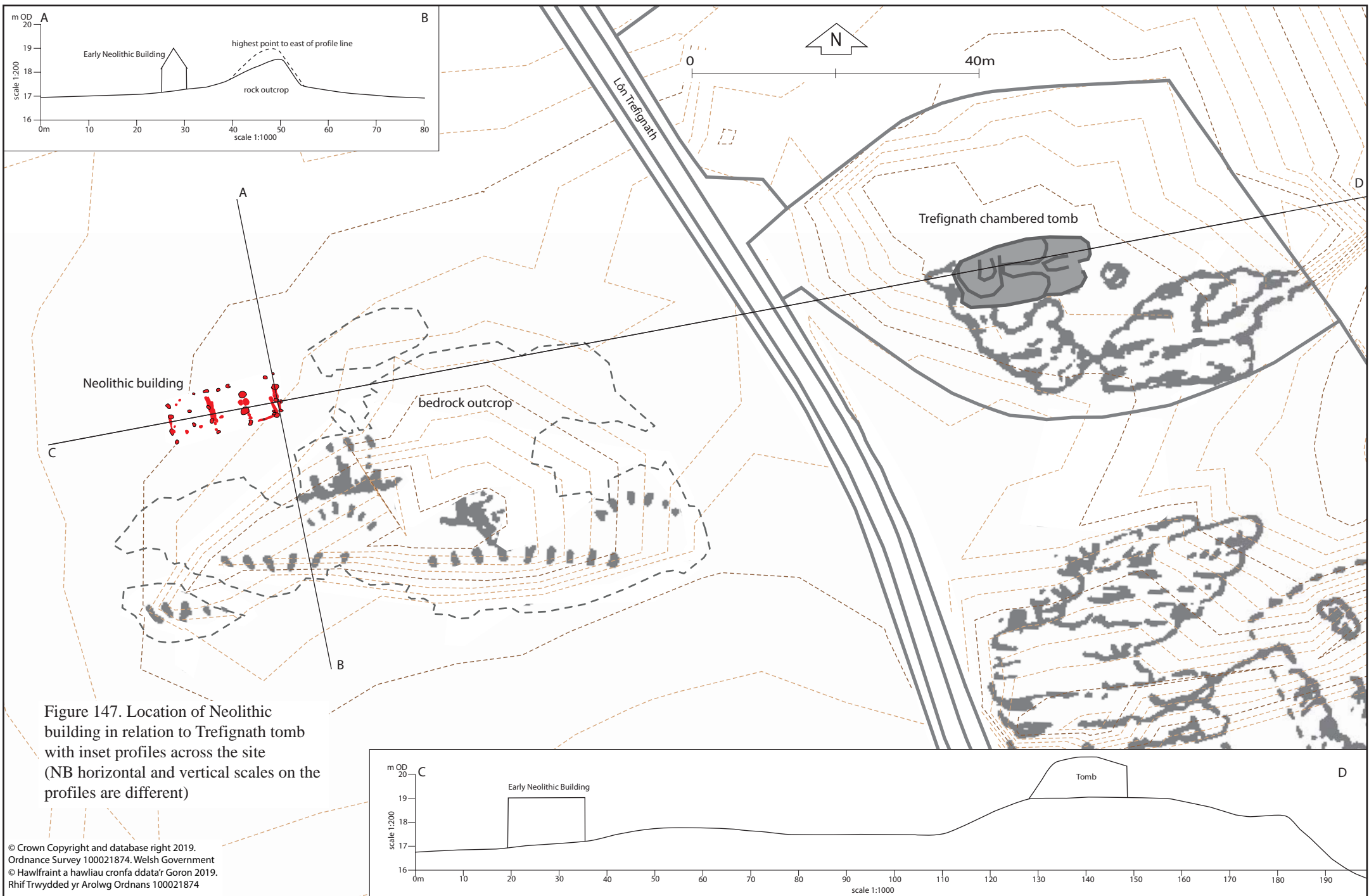

Figure 147. Location of Neolithic building in relation to Trefignath tomb with inset profiles across the site (NB horizontal and vertical scales on the profiles are different)

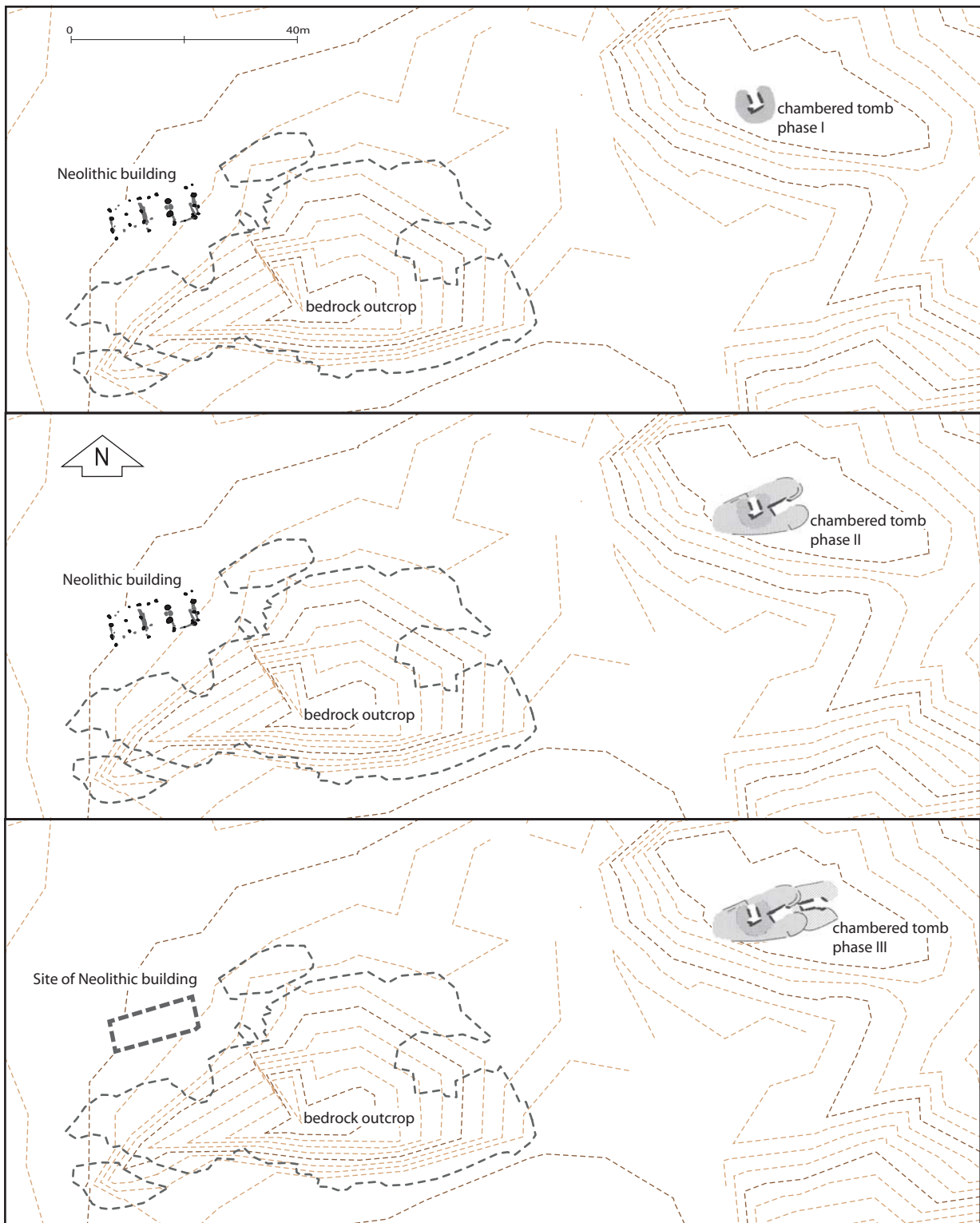

Figure 148. Proposed relationship of the Early Neolithic building and the tomb at the three stages of the tomb's development

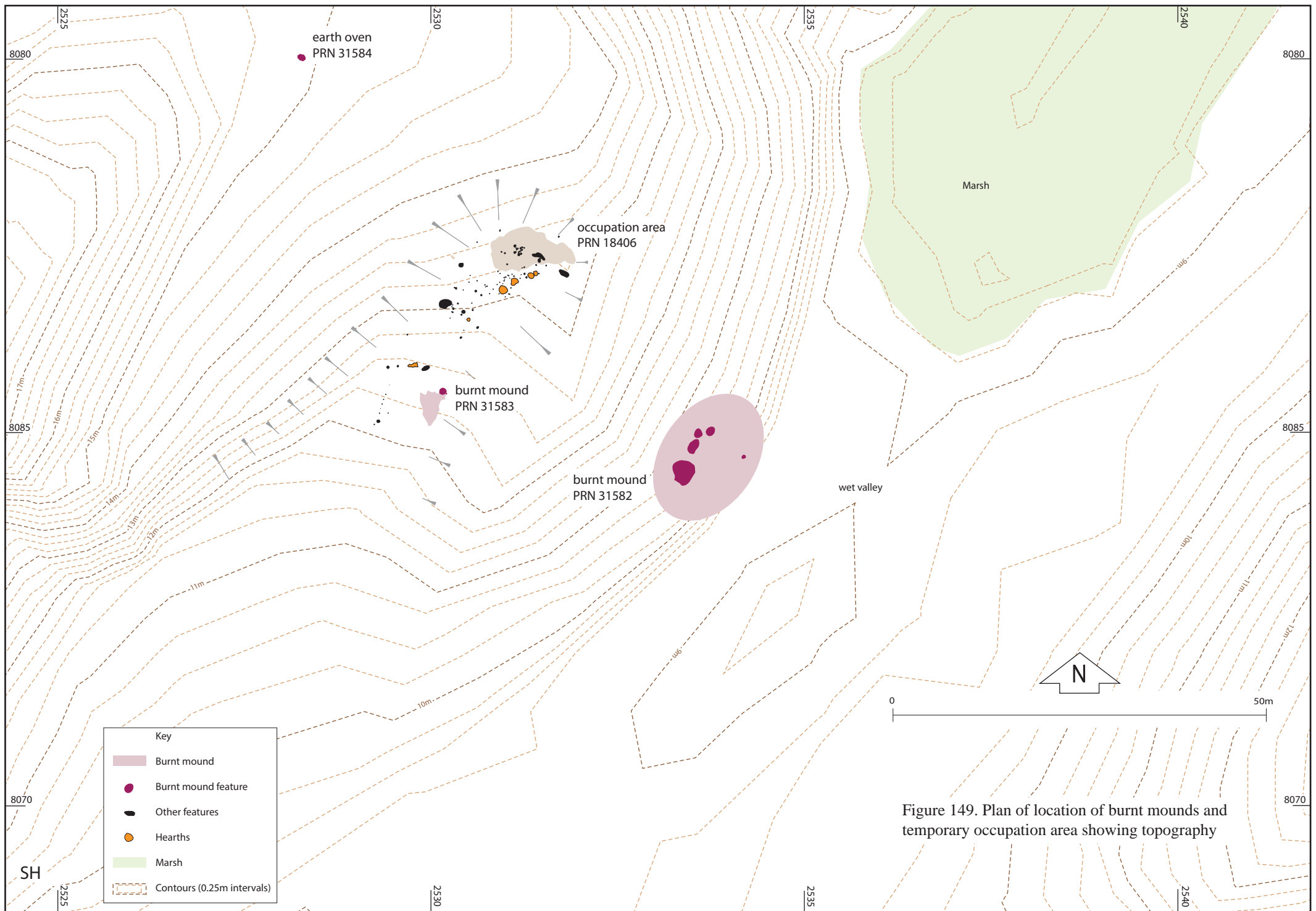

Figure 149. Plan of location of burnt mounds and temporary occupation area showing topography

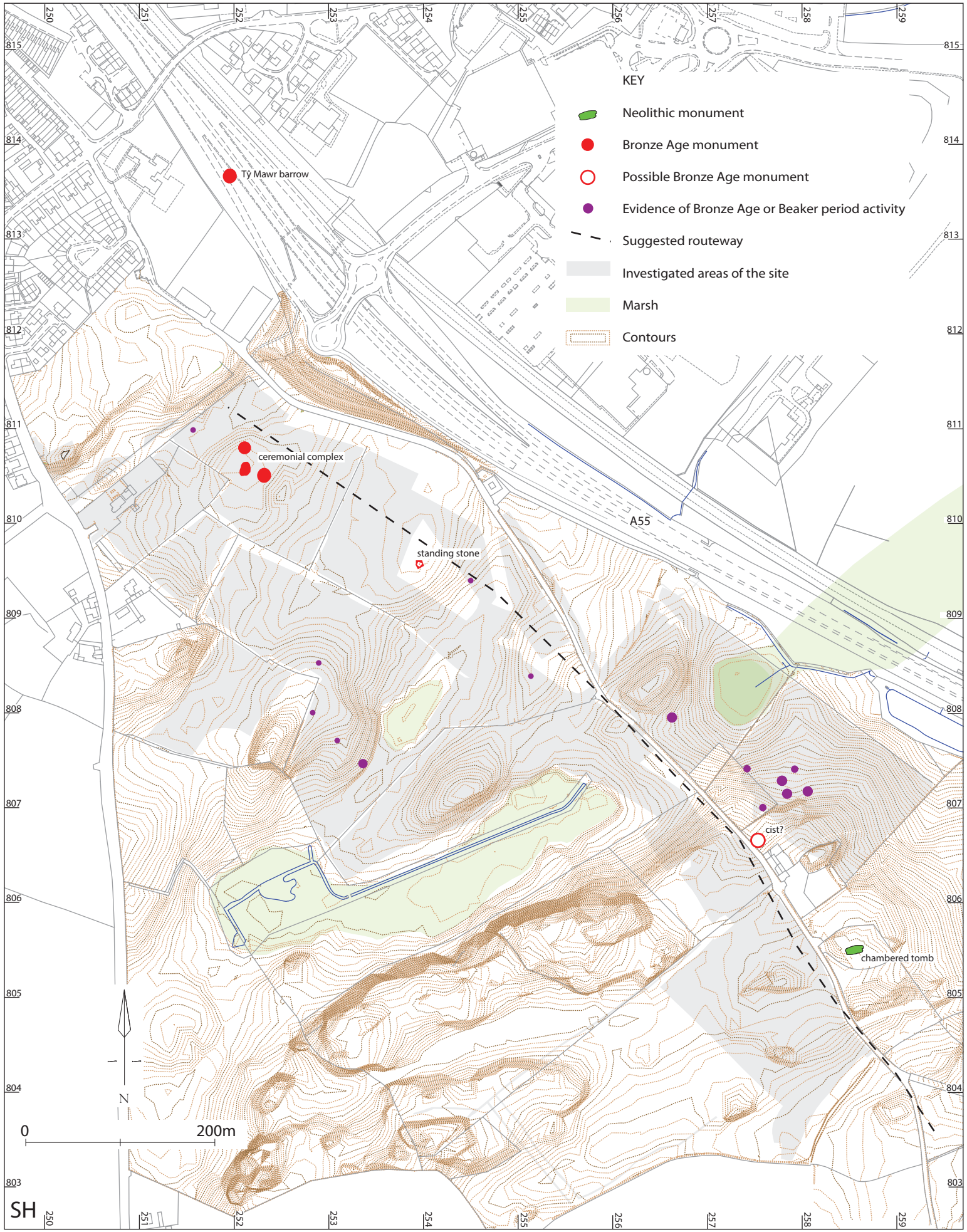
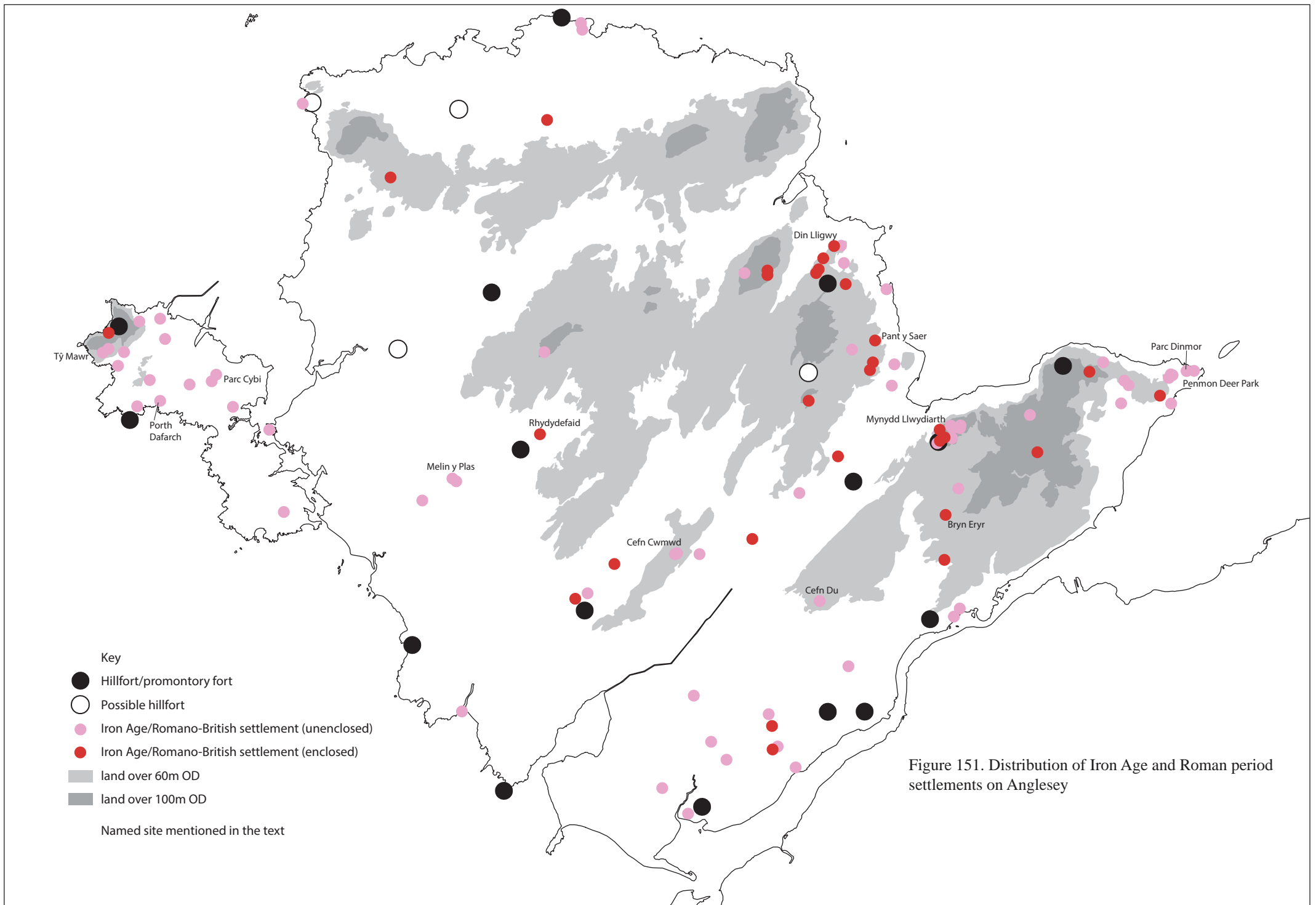
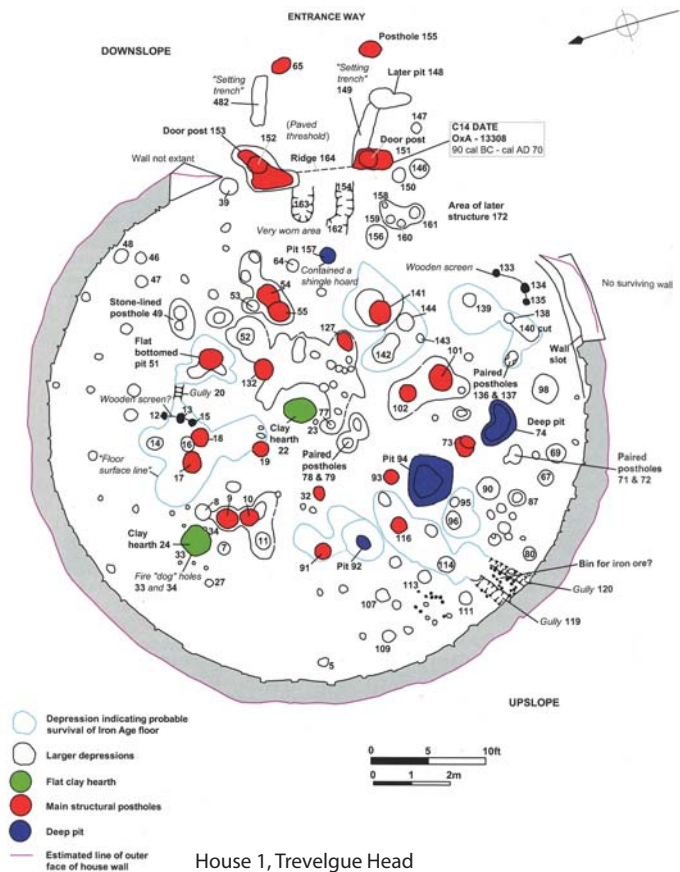

Figure 150. Bronze Age features on Parc Cybi in relation to the topography and chambered tomb with a proposed routeway





House 1, Trelvege Head
(after Nowakowski and Quinnell 2011 fig. 5.11,
reproduced with kind permission of Jacky Nowakowski)

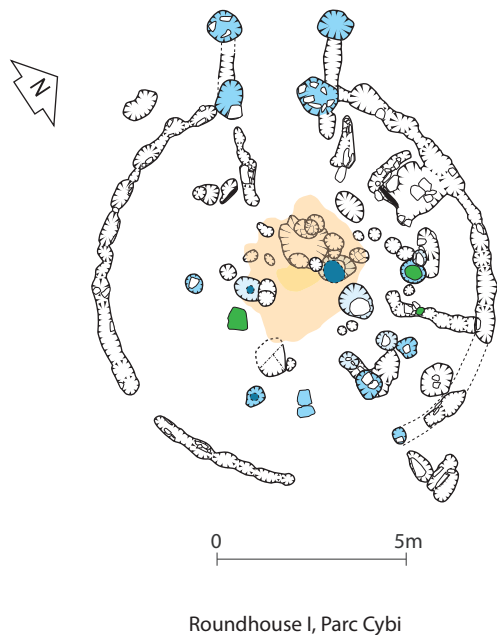

Figure 152. Plan of House 1, Trelvege Head compared to Roundhouse I, Parc Cybi

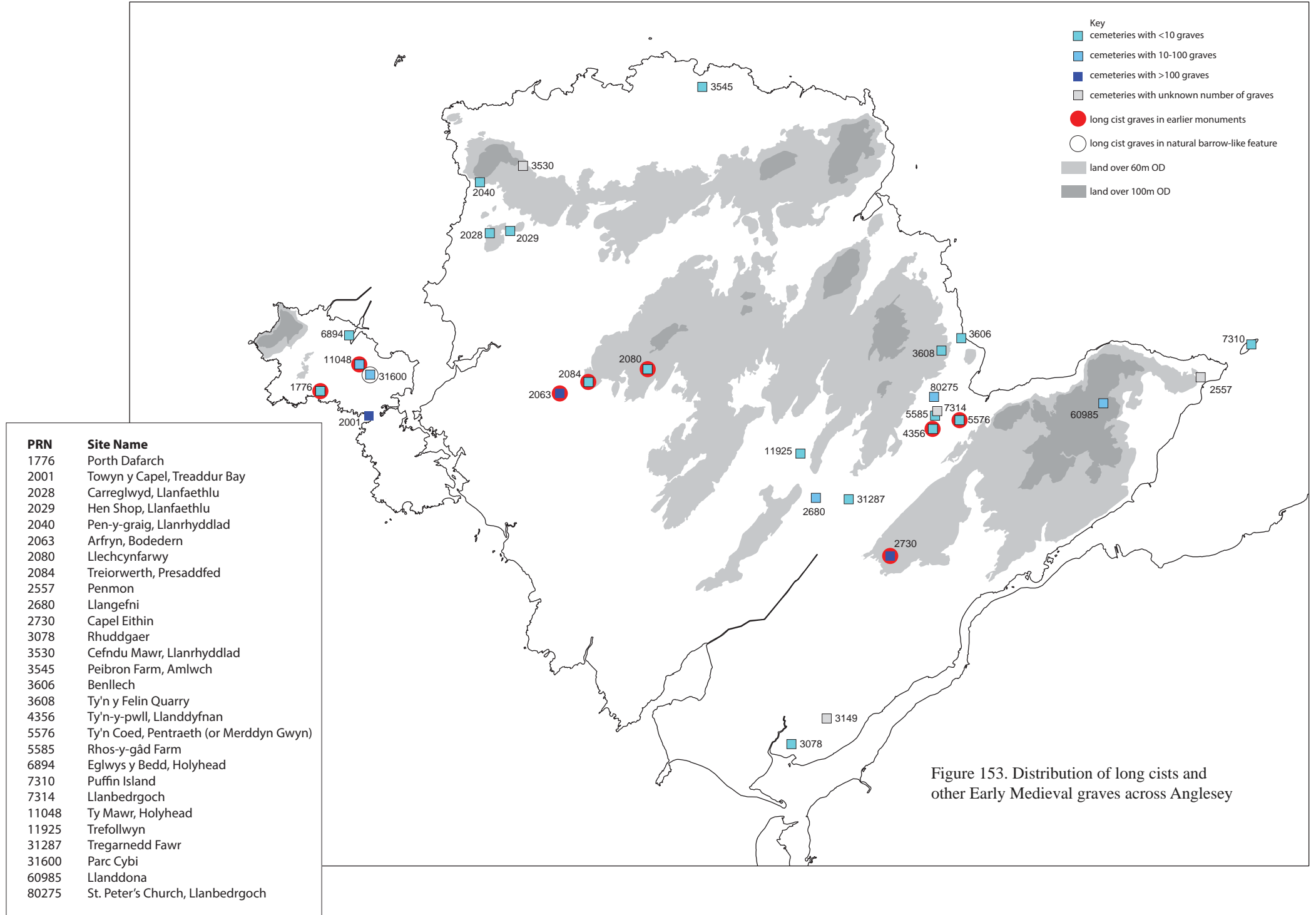

Figure 153. Distribution of long cists and other Early Medieval graves across Anglesey

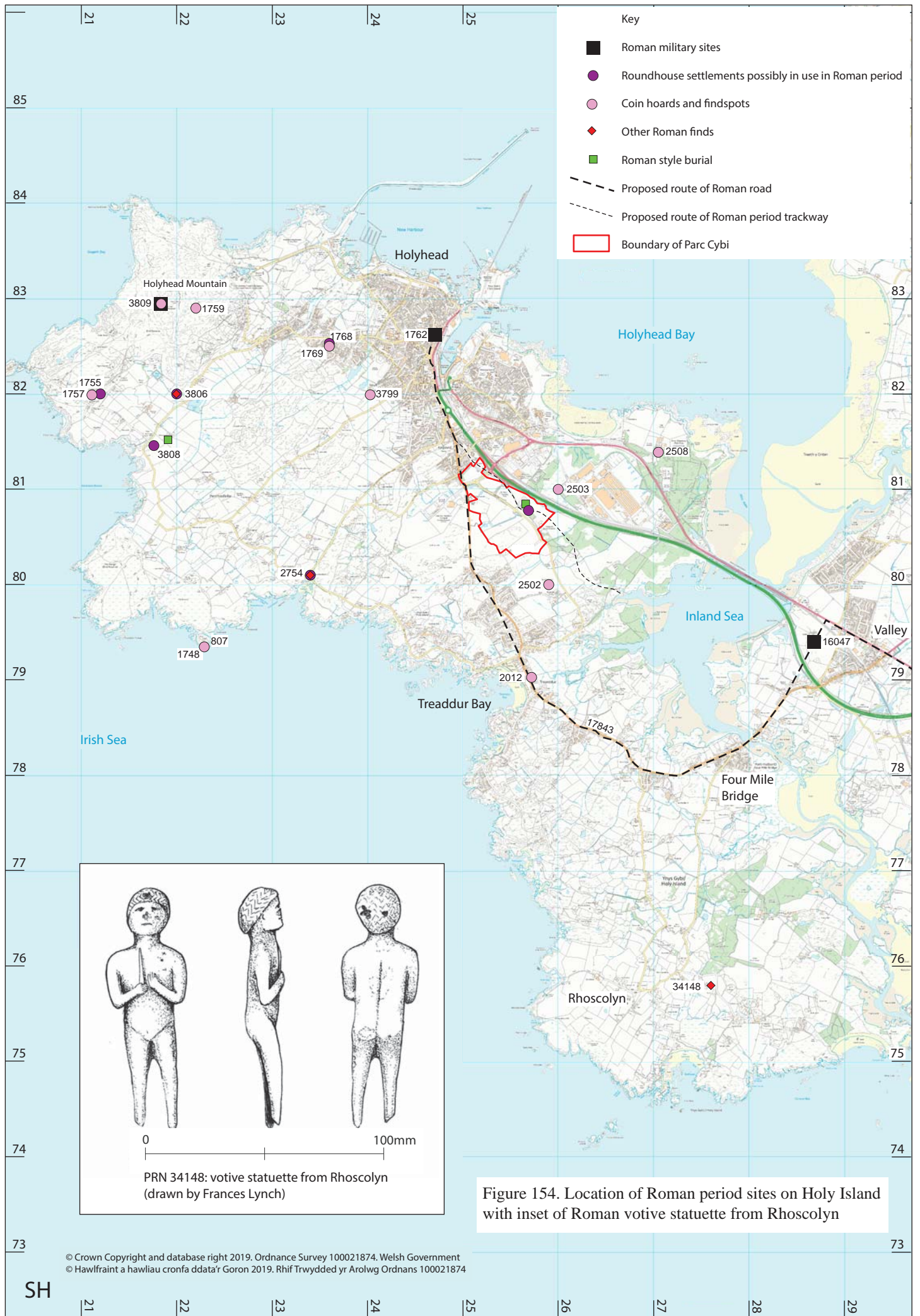
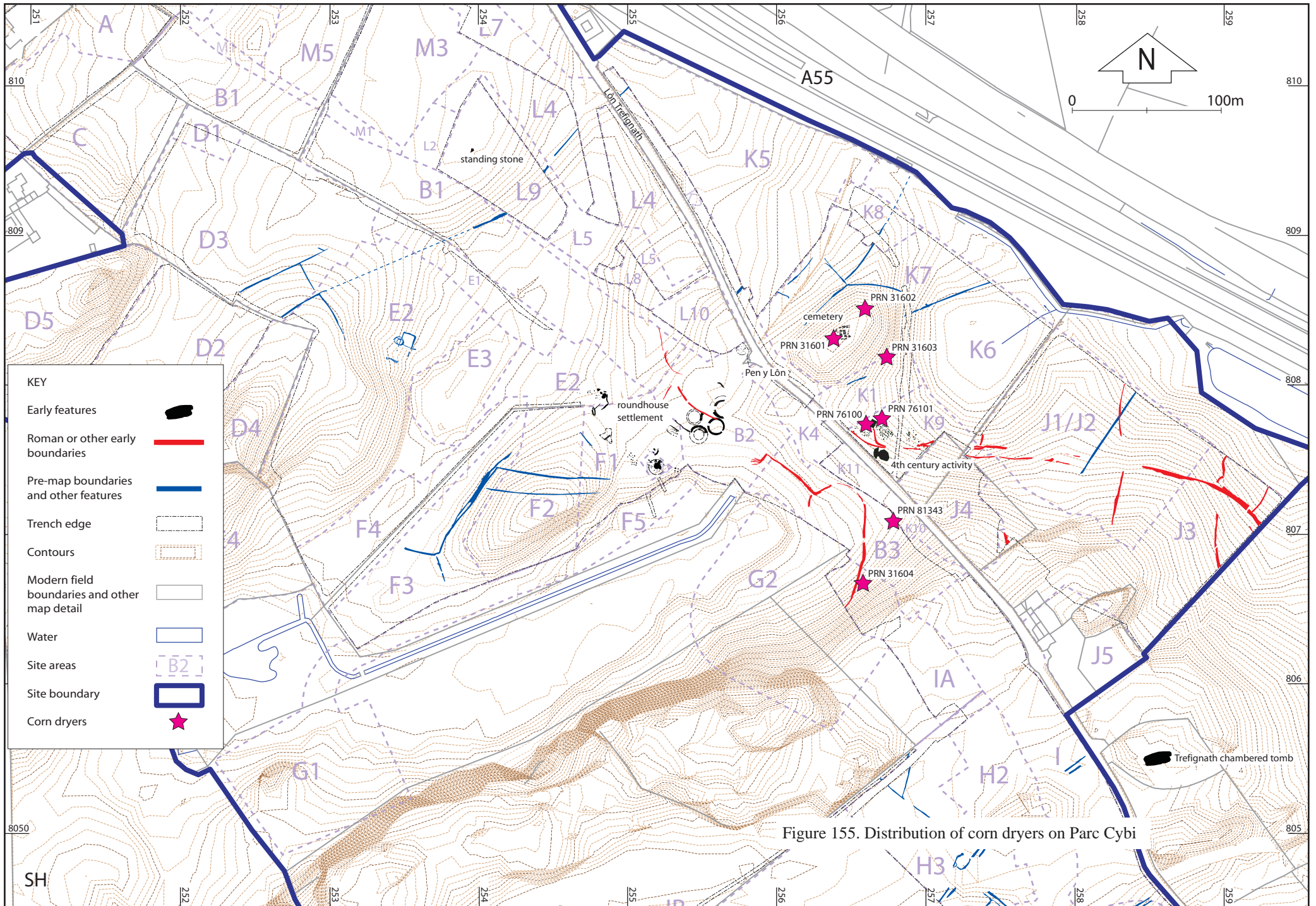
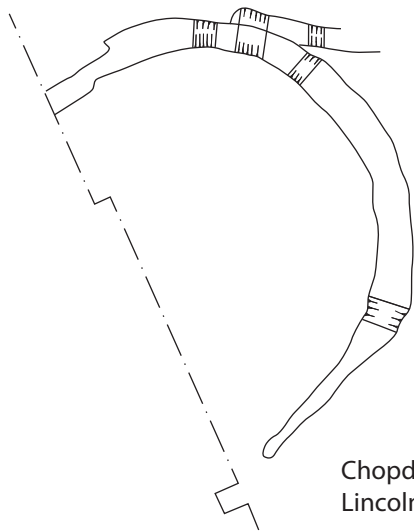
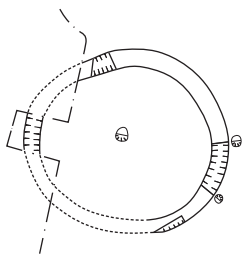
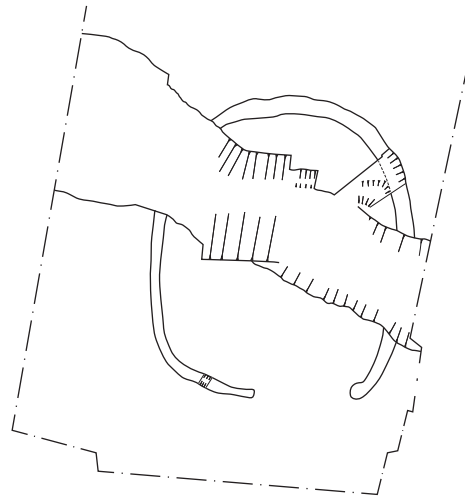

Figure 154. Location of Roman period sites on Holy Island with inset of Roman votive statuette from Rhoscolyn





Chopdike Drove, Gosberton,
Lincolnshire



Higham Ferrers,
Northamptonshire

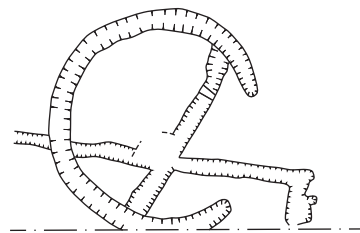

Wharram Percy, North
Yorkshire

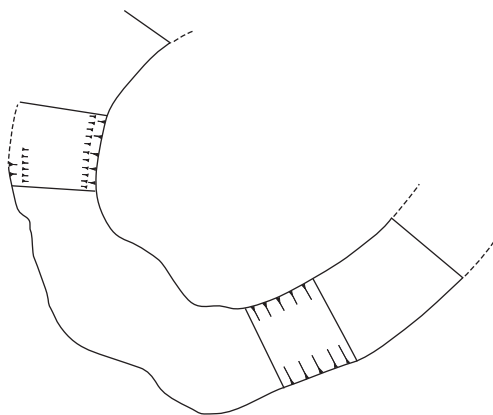

Ramsgate, Kent

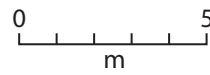

Figure 156. Excavated ring gullies from England
(part of figure 2.2 in Gardiner 2013, produced with the
author's kind permission and assistance)



Llywodraeth Cymru
Welsh Government



Gwynedd Archaeological Trust
Ymddiriedolaeth Archaeolegol Gwynedd



Craig Beuno, Ffordd y Garth, Bangor, Gwynedd. LL57 2RT
Ffon: 01248 352535. Ffacs: 01248 370925. email: gat@heneb.co.uk